

IND131

IND331

Terminals

PLC Interface Manual

© METTLER TOLEDO 2012

No part of this manual may be reproduced or transmitted in any form or by any means, electronic or mechanical, including photocopying and recording, for any purpose without the express written permission of METTLER TOLEDO.

U.S. Government Restricted Rights: This documentation is furnished with Restricted Rights.

Copyright 2012 METTLER TOLEDO. This documentation contains proprietary information of METTLER TOLEDO. It may not be copied in whole or in part without the express written consent of METTLER TOLEDO.

METTLER TOLEDO reserves the right to make refinements or changes to the product or manual without notice.

COPYRIGHT

METTLER TOLEDO® is a registered trademark of Mettler-Toledo, LLC. All other brand or product names are trademarks or registered trademarks of their respective companies.

METTLER TOLEDO RESERVES THE RIGHT TO MAKE REFINEMENTS OR CHANGES WITHOUT NOTICE.

FCC Notice

This device complies with Part 15 of the FCC Rules and the Radio Interference Requirements of the Canadian Department of Communications. Operation is subject to the following conditions: (1) this device may not cause harmful interference, and (2) this device must accept any interference received, including interference that may cause undesired operation.

This equipment has been tested and found to comply with the limits for a Class A digital device, pursuant to Part 15 of FCC Rules. These limits are designed to provide reasonable protection against harmful interference when the equipment is operated in a commercial environment. This equipment generates, uses, and can radiate radio frequency energy and, if not installed and used in accordance with the instruction manual, may cause harmful interference to radio communications. Operation of this equipment in a residential area is likely to cause harmful interference in which case the user will be required to correct the interference at his or her expense.

■ Declaration of Conformity is located on the documentation CD.

NOTE ON FIRMWARE VERSION

This manual describes features and functions of the IND131 and IND331 terminals with version 2.xx firmware. Terminals with a different version of firmware will differ in some areas.

FOLD THIS FLAP FIRST



NO POSTAGE
NECESSARY
IF MAILED IN THE
UNITED STATES

BUSINESS REPLY MAIL
FIRST CLASS PERMIT NO. 414 COLUMBUS, OH

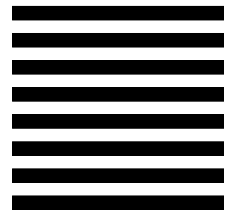

POSTAGE WILL BE PAID BY ADDRESSEE

Mettler-Toledo, LLC
Quality Manager - MTWT
P.O. Box 1705
Columbus, OH 43216
USA

Please seal with tape

PRECAUTIONS

- READ this manual BEFORE operating or servicing this equipment and FOLLOW these instructions carefully.
- SAVE this manual for future reference.

	 WARNING!
	FOR CONTINUED PROTECTION AGAINST SHOCK HAZARD CONNECT TO PROPERLY GROUNDED OUTLET ONLY. DO NOT REMOVE THE GROUND PRONG.

	 WARNING!
	WHEN THIS EQUIPMENT IS INCLUDED AS A COMPONENT PART OF A SYSTEM, THE RESULTING DESIGN MUST BE REVIEWED BY QUALIFIED PERSONNEL WHO ARE FAMILIAR WITH THE CONSTRUCTION AND OPERATION OF ALL COMPONENTS IN THE SYSTEM AND THE POTENTIAL HAZARDS INVOLVED. FAILURE TO OBSERVE THIS PRECAUTION COULD RESULT IN BODILY HARM AND/OR PROPERTY DAMAGE.

 CAUTION
BEFORE CONNECTING/DISCONNECTING ANY INTERNAL ELECTRONIC COMPONENTS OR INTERCONNECTING WIRING BETWEEN ELECTRONIC EQUIPMENT ALWAYS REMOVE POWER AND WAIT AT LEAST THIRTY (30) SECONDS BEFORE ANY CONNECTIONS OR DISCONNECTIONS ARE MADE. FAILURE TO OBSERVE THESE PRECAUTIONS COULD RESULT IN DAMAGE TO OR DESTRUCTION OF THE EQUIPMENT AND/OR BODILY HARM.

 CAUTION
OBSERVE PRECAUTIONS FOR HANDLING ELECTROSTATIC SENSITIVE DEVICES.

IND131, IND131xx, IND331 and IND331xx Terminals

METTLER TOLEDO Service



Essential Services for Dependable Performance of Your IND131/IND331 Terminal

Congratulations on choosing the quality and precision of METTLER TOLEDO. Proper use of your new equipment according to this Manual and regular calibration and maintenance by our factory-trained service team ensures dependable and accurate operation, protecting your investment. Contact us about a service agreement tailored to your needs and budget. Further information is available at www.mt.com/service.

There are several important ways to ensure you maximize the performance of your investment:

1. **Register your product:** We invite you to register your product at www.mt.com/productregistration so we can contact you about enhancements, updates and important notifications concerning your product.
2. **Contact METTLER TOLEDO for service:** The value of a measurement is proportional to its accuracy – an out of specification scale can diminish quality, reduce profits and increase liability. Timely service from METTLER TOLEDO will ensure accuracy and optimize uptime and equipment life.
 - a. **Installation, Configuration, Integration and Training:** Our service representatives are factory-trained, weighing equipment experts. We make certain that your weighing equipment is ready for production in a cost effective and timely fashion and that personnel are trained for success.
 - b. **Initial Calibration Documentation:** The installation environment and application requirements are unique for every industrial scale so performance must be tested and certified. Our calibration services and certificates document accuracy to ensure production quality and provide a quality system record of performance.
 - c. **Periodic Calibration Maintenance:** A Calibration Service Agreement provides on-going confidence in your weighing process and documentation of compliance with requirements. We offer a variety of service plans that are scheduled to meet your needs and designed to fit your budget

Content

Chapter 1	Analog Output Option	1-1
Overview	1-1
Specifications	1-1
Analog Output Operation	1-2
Hardware Setup	1-3
Wiring	1-4
Software Setup	1-4
Analog Output Setup Sub-Block	1-5
Troubleshooting	1-6
Procedure	1-6
Chapter 2	Modbus[®] RTU Option	2-1
Overview	2-1
Data Definition	2-2
Holding Registers 40001 thru 40011 Assignments	2-2
Calibrating the Scale via Modbus RTU	2-8
Controlling the Discrete I/O	2-9
Wiring	2-9
Software Setup	2-11
Connections Sub-Block	2-11
Hardware Setup	2-11
Serial Sub-Block	2-11
Troubleshooting	2-13
Chapter 3	A-B RIO Option	3-1
Overview	3-1
Communications	3-2
Node/Rack Address	3-2
Data Formats	3-3
Hardware Setup	3-3
Wiring	3-3
Software Setup	3-4
A-B RIO Setup Sub-Block	3-4
Troubleshooting	3-5
Procedure	3-5
Interfacing Examples	3-6
Chapter 4	ControlNet Option	4-1
Overview	4-1
Definition of Terms	4-2
Communications	4-3
Node Address	4-3
Data Formats	4-4
Data Definition	4-4
Assembly Instances of Class 1 Cyclic Communications	4-4
Hardware Setup	4-4

Wiring.....	4-4
Software Setup	4-5
ControlNet Setup Sub-Block.....	4-5
Troubleshooting	4-7
Procedure.....	4-7
Programming Examples.....	4-8
Integer/Divisions.....	4-8
Floating Point.....	4-19
Chapter 5 DeviceNet Option	5-1
Overview	5-1
DeviceNet Characteristics	5-1
Communications	5-2
Node Address	5-2
Network Power and Current.....	5-3
Data Formats.....	5-3
Hardware Setup	5-3
Wiring.....	5-3
Software Setup	5-4
DeviceNet and Data Format Setup Blocks.....	5-4
Troubleshooting	5-5
Commissioning and Configuration Examples	5-7
Configuring the IND131/IND331 Terminal with RSNetWorx for DeviceNet.....	5-7
PLC Programming	5-20
Chapter 6 EtherNet / IP Option	6-1
Overview	6-1
Definition of Terms.....	6-2
Communications	6-3
IP Address.....	6-3
Data Formats.....	6-3
Assembly Instances of Class 1 Cyclic Communications	6-4
Hardware Setup	6-4
Wiring.....	6-4
Software Setup	6-5
EtherNet / IP Setup Block	6-5
Troubleshooting	6-6
Procedure.....	6-7
Programming Examples.....	6-7
Chapter 7 Modbus TCP Option	7-1
Overview	7-1
Specifications.....	7-1
Modbus TCP Characteristics	7-2
Communications	7-2
IP Address.....	7-2
Data Formats	7-2
Hardware Setup	7-3
Wiring.....	7-3

Software Setup	7-3
Modbus TCP Setup Block.....	7-4
Troubleshooting	7-5
Procedure.....	7-6
Chapter 8 PROFIBUS Option	8-1
Overview	8-1
Communications	8-2
Node Address	8-4
Data Formats.....	8-4
PROFIBUS GSD or Type Files	8-4
Hardware Setup	8-4
Wiring.....	8-4
Software Setup	8-5
PROFIBUS Setup Sub-Block.....	8-5
Troubleshooting	8-6
Integer/Division Interfacing Examples.....	8-7
Floating Point Interfacing Examples	8-8
Appendix A Data Definition	A-1
Overview	A-1
Data Formats.....	A-1
Message Size	A-3
Integer and Division	A-3
Floating Point.....	A-4
Register Mapping – Modbus TCP Only	A-5
Assembly Instances of Class 1 Cyclic Communications – EtherNet / IP Only	A-6
Byte Order	A-6
Data Integrity	A-7
Format Details	A-7
Integer and Division	A-7
Floating Point.....	A-10
Floating Point Data Integrity and Compatibility	A-15
Floating Point Command Examples.....	A-17
Floating Point PLC Calibration Example	A-21
Controlling the Discrete I/O Using a PLC Interface	A-23

Chapter 1

Analog Output Option

Overview

This chapter covers

- Overview
- Specifications
- Analog Output Operation
- Hardware Setup
- Software Setup
- Troubleshooting

The Analog Output option kit provides one channel of an isolated 4-20 mA analog signal output for displayed weight, gross weight or rate (selected in setup). The analog output uses a 16-bit D/A converter for a very precise output. The output signals will be at the lower limit (4 mA) when the value represented is at zero. When the value reaches its maximum limit, the output signal will increase to higher limit (20 mA). Any value between zero and the maximum limit will be represented as a percentage of the output proportional to the percentage of the value.

The Analog Output sub-block lets you select the data source for the analog signal and provides a method to calibrate the analog zero and high limit values. The IND131 and IND331 terminals must be calibrated to the desired scale capacity before making Analog Output adjustments. If rate is to be used as the source for the analog output signal, the rate function must be enabled in the Scale > Rate branch of setup.

Specifications

Maximum Cable Length:	300 m (1000 ft.)
Min/Max Load Resistance:	500 Ω maximum
Resolution:	16 bit resolution - 65536 levels across entire range
Error Indication:	Two open collector error signals to indicate error conditions of the terminal. Labeled as Under and Over.

- Note that if the maximum load resistance value is exceeded, the analog output will not operate properly.

Figure 1-1 shows the Analog Output Option Board with its connector.



Figure 1-1: Analog Output Option Board

Analog Output Operation

The source for the analog output can be selected as Absolute Value of Displayed Weight, Absolute Value of Rate, Displayed Weight, Gross Weight or Rate. Regardless of the source selected, the analog output signal operates as described next.

Under Zero	When the source value drops below zero, the analog signal continues to decrease below 4mA. This continues until approximately 2.5mA. When the under zero display blanking point is reached, or the analog signal negative range is exceeded, the analog output immediately switches to 0 mA and remains there until the display is no longer blanked or the analog signal returns to within range. The under error output will also be turned on.
Normal Range	The analog output will reflect the source value from 4mA (zero setting) to 20mA (high limit setting).
Over High Limit	When the source value exceeds the high limit, the analog signal continues to increase. This continues until approximately 21.5mA. When the display blanking point is reached, or the analog signal positive range is exceeded, the analog output immediately switches to approximately 24 mA and remains there until the weight display is no longer blanked or the analog signal returns to within range. The over error output will also be turned on.

Table 1-1 summarizes the function of the analog output under zero and over the high limit, and the operation of the under and over error signals.

Table 1-1: Analog Signal Operation

Error Outputs and Analog Signal Operation			
Condition of Weight or Rate	Analog Signal	Over Error	Under Error
Blanked under zero (blanking range 5d)	0mA	OFF	ON
Under zero more than 10% of span (blanking range disabled)	0mA	OFF	ON
Under zero but not blanked (blanking range 5d)	3.95 - 4.0 mA	OFF	OFF
Under zero less than 10% of span and analog output still functional (blanking range disabled)	2.4 – 4.0 mA	OFF	OFF
Normal operating range	4 - 20 mA	OFF	OFF
Above full scale value but within 10% of analog span (display not blanked)	20 – 21.6 mA	OFF	OFF
Above full scale value more than 10% of analog output span, but not over capacity blanked	25 mA	ON	OFF
Blanked over capacity and analog out of range	25mA	ON	OFF
In Setup mode	25mA	ON	OFF

- In order to use Absolute Value of Rate or Rate as the source, it must be enabled in setup at Scale > Rate.

Hardware Setup



CAUTION

OBSERVE PRECAUTIONS FOR HANDLING ELECTROSTATIC SENSITIVE DEVICES.

The analog output option for all enclosure types can be installed at the factory or it can be ordered as a kit and installed in the field. The option kit includes detailed drawings to assist in the installation.

Wiring



⚠ WARNING!

DISCONNECT ALL POWER TO THIS UNIT BEFORE SERVICING. DO NOT APPLY POWER TO THE TERMINAL UNTIL INSTALLATION OF COMPONENTS AND EXTERNAL WIRING HAVE BEEN COMPLETED.

⚠ WARNING!

IF THIS DEVICE IS USED IN AN AUTOMATIC OR MANUAL FILLING CYCLE, ALL USERS MUST PROVIDE A HARD-WIRED EMERGENCY STOP CIRCUIT OUTSIDE THE DEVICE OF CIRCUITRY. FAILURE TO OBSERVE THIS PRECAUTION COULD RESULT IN BODILY INJURY.

The maximum recommended cable length for the 4-20 mA output is 1,000 feet (300 meters). The recommended cable for use with the analog output is shielded two-conductor stranded 20-gauge cable (Belden #8762 or equivalent), which is available from METTLER TOLEDO using part number 510220190. See Figure 1-2 for connection and termination information.

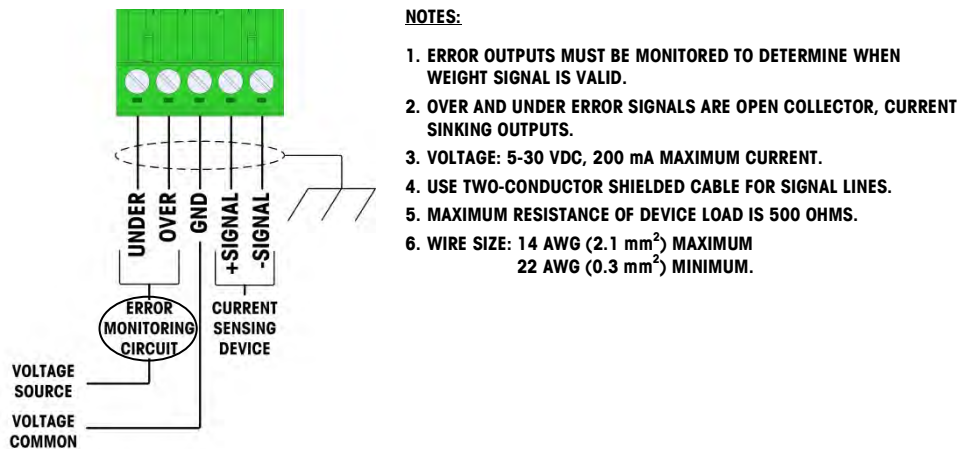

Figure 1-2: Analog Output Kit Wiring Connections

Software Setup

Figure 1-3 illustrates the setup menu for configuring the Analog Output option. Both the English and F-code formats are shown. The branches in this group are Source, Zero Value, Full Scale Value and Calibrate Output.

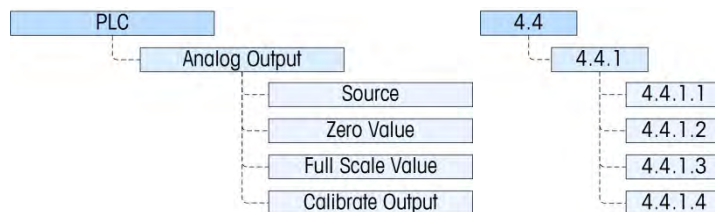

Figure 1-3: Setup Procedures for Configuring the Analog Output Option Card

In this section, figures given in brackets (e.g. [0]) correspond to the parameter options available when F-codes are displayed by the terminal.

Analog Output Setup Sub-Block

To configure the Analog Output Kit Option:

Source – F4.4.1.1

The IND131/331 analog output option provides a 4 - 20 mA output signal which can represent either the weight or the rate. In the Source selection menu, select the output source as **None** [0] (the default), **ABS – Displayed Weight** [4], **ABS – Rate** [5], **Displayed Weight** [1], **Gross Weight** [2], or **Rate** [3]. The ABS selections will reflect the absolute value of either the weight or rate.

Zero Value – F4.4.1.2

The Zero Value menu allows a numeric entry to be made, setting the displayed value equivalent for the analog output's 4mA (zero) level. For a standard weighing application, this would be **00000** reflecting zero weight on the scale.

- Note that negative values for the zero reference point cannot be entered from the front panel of the terminal but they can be entered via the Variable Access mode for any special applications that require this.

Full Scale Value – F4.4.1.3

The Full Scale Value menu allows a numeric entry to be made, setting the displayed value equivalent for the analog output's 20mA (full scale) level. For a standard weighing application, this would be the capacity of the scale.

Calibrate Output – F4.4.1.4

Pressing the PRINT key at the **Calibrate Output** menu initiates a calibration routine that allows correlation of the zero and full scale analog output points of the terminal to what the connected device is expecting. The procedure follows these steps:

1. First, a message is shown **WARNING! Analog Output will change** indicating that the analog output will be controlled by the terminal for calibration purposes and will not represent the weight or rate as normal.
2. After accepting this message by pressing PRINT, a second message appears – **Signal now 4mA. Adjust then ENTER**. Use the TARE key to increase the analog signal or the CLEAR key to decrease the analog output signal to fine tune the output for the 4mA (zero) reference. Press ENTER when done.
3. The message **WARNING! Analog Output will change** is shown again indicating the analog output will change and is not related to the source value. Press PRINT to accept the message.
4. The next message is **Signal now 20mA. Adjust then ENTER**. Press the PRINT key to continue.

5. Use the TARE key to increase the analog signal or the CLEAR key to decrease the analog output signal to fine tune the output for the 20mA (full scale) reference. Press PRINT when done.

Troubleshooting

Procedure

If the analog output option of the IND131/331 does not communicate with the connected 4-20mA device, do the following:

- Check wiring and termination.
- Confirm that the IND131/331 setting for source is correct.
- Calibrate the analog output of the IND131/331 terminal then confirm operation with a digital volt meter with the external device disconnected.
- Confirm the connected device has a maximum input resistance of 500 ohms.
- If none of the checks above resolve the issue, contact an authorized service location of METTLER TOLEDO.

Chapter 2

Modbus[®] RTU Option

Overview

This chapter covers

- Overview
- Data Definition
- Hardware Setup
- Software Setup
- Troubleshooting

Modbus protocol is a messaging structure developed by Modicon and supported today by the Modbus Organization. It is used to establish master-slave/client-server communication between intelligent devices. It is an open standard network protocol, widely used in the industrial manufacturing environment.

The IND131/IND331 can be set up to communicate via Modbus RTU from COM port 2. The COM2 serial port is part of the COM2/Discrete I/O option board. There are two versions of this board, depending upon the version of discrete output devices. Both versions support the same

COM2 functions.

Only MODBUS-RTU commands 03H and 06H are supported by the IND131/IND331. The master reads data from the IND131/IND331 registers 40001 through 40011 using the Read Holding Register command 03H. The master writes data to the individual IND131/IND331 registers using the Write Single Register command 06H.

The IND131/IND331 data contains numerical and status information and commands. The type of numerical data sent to and from the IND131/IND331 terminal is available in either Integer or Division format. Only one type of data format can be set up and used at one time by the IND131/331; the format is selected in setup.

- **Integer Mode** – reports scale weight as a signed 16 bit integer (± 32767).
- **Divisions Mode** – reports scale weight in display divisions (± 32767). The PLC must multiply the reported number of divisions by the increment size to calculate the weight in display units.

Figure 2-1 shows the COM2/DIO (relay) version of the Modbus RTU interface and Figure 2-2 shows the COM2/DIO (solid state version). The COM2 serial connector is the one in the lower left corner in the photos.

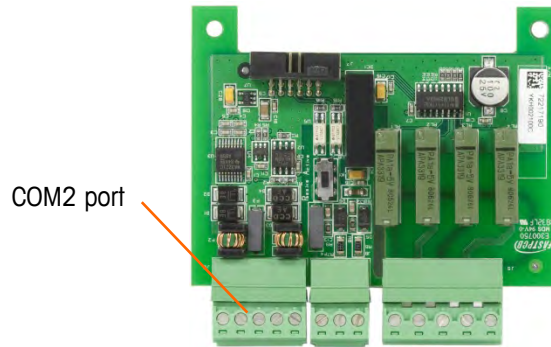

Figure 2-1: COM2/DIO (relay) Option Board

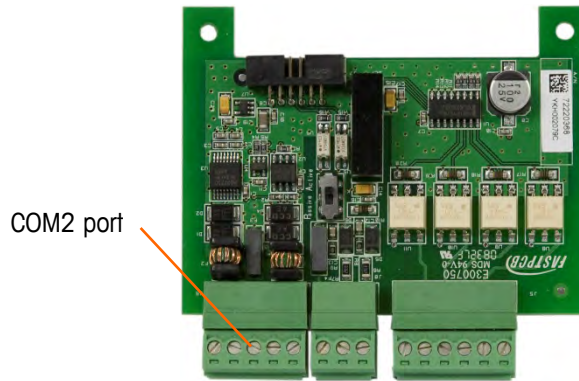

Figure 2-2: COM2/DIO (solid state) Option Board

Data Definition

Holding Registers 40001 thru 40011 Assignments

Table 2-1 shows the holding register assignment. Note that the register addresses are PLC-dependent. Table 2-1 shows the register addresses as 5 digits. If the register addressing is 4 digits, the address range would be 4001 thru 4011. If the register addressing is 6 digits, the address range is 400001 thru 400011. The addressing is based on the type of PLC used. In any case, the IND131/IND331 registers are mapped to the first eleven holding registers.

Table 2-1: Modbus RTU Holding Register Assignment (Integer and Division)

Register Address	Read/Write	Description
40001	R	Displayed weight
40002	R	Tare weight
40003	R	Data available here is selected by setting bits Select 1, Select 2 and Select 3 at address 40006 (refer to Table 2-4)
40004	R	Scale status bits
40005	R/W	Write weight or value

Register Address	Read/Write	Description
40006	R/W	Write command
40007	R/W	Write Variable Selection
40008	R/W	Write Value(selected by 40007)
40009	R/W	Write Read Value Selection
40010	R	Read Value(selected by 40009)
40011	R	Read Value selection

Address 40001

Displayed Weight is read from address 40001.

Address 40002

Tare Weight is read from address 40002.

Address 40003

Data read from address 40003 can represent gross weight, net weight, tare weight, target value, fine feed value, spill value or tolerance value.

The type of data to be read from register 40003 is selected by the Select 1, Select 2 and Select 3 bits in command register 40006. See Table 2-4 for the definition of these bits. Use these bits to verify that data (Target, Fine Feed, Spill and Tolerance) sent to the IND131 is correct.

Address 40004

Address 40004 contains bit encoded status information. Table 2-2 shows the function of each bit.

Table 2-2: Address 40004 Bit Functions

Bit number	Function
0	Feed ¹
1	Fast Feed ¹
2	Tolerance OK ¹
3	Not Used
4	Not Used
5	Comparator 3 ²
6	Comparator 2 ²
7	Comparator 1 ²
8	Not Used
9	Input 1 ³
10	Input 2 ³
11	Not Used

Bit number	Function
12	Motion ⁴
13	Net Mode ⁵
14	Update in Process ⁶
15	Data OK ⁷

Notes for Table 2-2

- 1 **Bits 0, 1 and 2** indicate the state of the target comparison logic. When in the material transfer mode; **bit 0** is Feed, **bit 1** is Fast Feed and **bit 2** is Tolerance Ok (within range).
- 2 **Bits 5, 6, and 7** indicate the state of the associated comparator logic; when the bit is set to '1' the comparator state is 'ON'; when the bit is set to '0' the comparator state is 'OFF'. The setup of each comparator will determine when the state is 'ON' or 'OFF'.
- 3 **Bits 9 and 10** indicate the state of the associated hardware discrete input in the terminal; these are Input 1 and Input 2. When the input is 'ON' the associated bit is set to '1'.
- 4 **Bit 12;** The motion bit is set to '1' when the scale is in motion (unstable).
- 5 **Bit 13;** The net mode bit is set to '1' when scale is in the net mode (a tare has been taken). When the scale is in the gross mode, the bit will be '0'.
- 6 **Bit 14** (update in process) is set to '1' when the terminal is in process of updating the data to the PLC communications adapter. The PLC should ignore all data while this bit is set to '1'.
- 7 **Bit 15;** The data ok bit is set to '1' when the terminal operating conditions are normal. The bit is set to '0' during power-up, during terminal setup, when the scale is over capacity or under zero, and when in the x10 display mode; additionally, the first word integer value is set to '0'. The PLC should continuously monitor the data ok bit to determine the validity of the data in the PLC.

Address 40005

The master writes values to this address. The value (in integer or division format) represents data that is to be written to the IND131/IND331 memory. The value can represent a target value, tolerance value, fine feed value, spill value or a preset tare. Bits in address 40006 set the data type and indicate to the terminal which field is being sent.

It is important that the data is first written to address 40005 and then the respective bit is set in address 40006.

As an example: To send a preset tare value of 123 to the IND131/IND331 the master would first write 123 to address 40005 and then set the Preset Tare bit (Bit 3) in address 40006 to a "1". (Refer to Table 2-3).

Address 40006

The master writes discrete commands to the IND131/IND331 via address 40006. The commands are shown in Table 2-3.

Table 2-3: Address 40006 Functions

Bit number	Function [Scale Command]
0	Select 1 ¹
1	Select 2 ¹
2	Select 3 ¹
3	Load Preset Tare ²
4	Clear Tare ³
5	Tare ⁴
6	Print ⁵
7	Zero ⁶
8	Target Control ⁷
9	Load Fine Feed Value ⁸
10	Load Spill Value ⁹
11	Load Tolerance Value ¹⁰
12	Output 1 ¹¹
13	Output 2 ¹¹
14	Output 3 ¹¹
15	Load Target Value ¹²

Notes for Table 2-3

- 1 **Bits 0, 1 and 2** change the data being sent from the terminal in Address 40003. Use a decimal value in binary format within **bits 0, 1, and 2** to change the data reported by the terminal. Use these bits to verify that the values sent to the IND131/IND331 (such as Fine Feed, Tolerance, etc.) are correct. Refer to Table 2-4 for details of the bits.

Table 2-4: Select 1, 2 and 3

Select 3	Select 2	Select 1	
0	0	0	Gross weight
0	0	1	Net weight
0	1	0	Tare weight
0	1	1	Target value
1	0	0	Fine feed value
1	0	1	Spill value
1	1	0	Both Positive / Negative tolerance
1	1	1	Gross weight

- 2 **Bit 3** - A transition from '0' to '1' will cause the value in address 40005 to be loaded into the tare register of the terminal and set the terminal into the net mode. Set this bit to '1' only after address 40005 has been loaded with the required value.
- 3 **Bit 4** - A transition from '0' to '1' will cause the terminal tare register to be set to '0' and the terminal will be set to the gross weight mode.

- 4 **Bit 5** - A transition from '0' to '1' will cause the weight on the scale to be used as the tare value and set the terminal to the net mode (equivalent to a tare command). The scale will not tare while motion is detected. If the scale does not tare within 3 seconds the command must be resent.
- 5 **Bit 6** - A transition from '0' to '1' will issue a print command.
- 6 **Bit 7** - A transition from '0' to '1' will cause the scale to re-zero, but only within the ranges established in scale setup.
- 7 **Bit 8** - If target latching is enabled, a transition from '0' to '1' initiates a "Start Target" command and a transition from '1' to '0' initiates an "Abort Target" command.
If target latching is disabled, a transition from "0" to "1" initiates a Enable Target command
The use of both the PLC and the terminal console keypad and/or a remote input is not advised, as unexpected results may occur.
- 8 **Bit 9** - A transition from '0' to '1' will cause the value in address 40005 to be loaded into the fine feed value register of the terminal and will be used the next time the target logic is started. Set this bit to '1' only after address 40005 has been loaded with the required value.
- 9 **Bit 10** - A transition from '0' to '1' will cause the value in address 40005 to be loaded into the spill value register of the terminal and will be used the next time the target logic is started. Set this bit to '1' only after address 40005 has been loaded with the required value.
- 10 **Bit 11** - A transition from '0' to '1' will cause the value in address 40005 to be loaded into the tolerance value register of the terminal and will be used the next time the target logic is started. Set this bit to '1' only after address 40005 has been loaded with the required value.
- 11 **Bits 12, 13 and 14** will cause the associated hardware discrete output to be turned 'ON' and 'OFF'. Setting a bit to '1' will cause the output to turn 'ON'; setting the bit to '0' will cause the output to turn 'OFF'. The PLC control will not override the status of the outputs if they are being used by the terminal logic as programmed in setup of the terminal. Leave the outputs assigned as None in setup to allow the PLC to have control.
- 12 **Bit 15** - A transition from '0' to '1' will cause the value address 40005 to be loaded into the target register of the terminal and will be used the next time the target logic is started. Set this bit to '1' only after address 40005 has been loaded with the required value.

Address 40007

The master writes calibration commands to address 40007. The master must send a Clear Command ("0") before each Calibrate Command is sent. The IND131/IND331 is waiting for the command to go to "0" before another command is acknowledged. The read values and write values for address 40007 do not coincide. The commands are listed in Table 2-5.

Table 2-5: Calibration Commands

Command	Function
0	Clear Command Register
40 (dec)	Calibrate Zero
41 (dec)	Calibrate Span #1
42 (dec)	Calibrate Span #2
602 (dec)	Load Span #1 weight from address 40008

Command	Function
604 (dec)	Load Span #2 weight from address 40008

Address 40008

The master writes values to address 40008. Commands in address 40007 load the value from address 40008 to the appropriate IND131/IND331 calibration register.

Address 40009

The master writes command values to address 40009 to read various calibration parameters including the status and test weight values. The requested data is reported in address 40010.

Table 2-6: Report Calibration Information Command

Command	Function
26 (dec)	Calibration Status Request
602 (dec)	Report Test Weight #1
604 (dec)	Report Test Weight #2

Address 40010

Address 40010 reports either the status of the calibration or the calibration test weight values depending upon what command has been written to address 40009 and address 40011. Details are given in Table 2-7.

Table 2-7: Calibration Information

Report Calibration Info Command (Address 40009)	Response in Address 40010
26 (dec)	0 – Adjustment OK 1 – Adjustment in progress 10 (dec) – Adjusting dynamically 255 (dec) – Adjustment failure
602 (dec)	Test Weight #1 value (if the value in address 40011 is equal to 602 (dec)).
604 (dec)	Test Weight #2 value (if the value in address 40011 is equal to 604 (dec)).

Address 40011

Address 40011 reports test weight #1 and #2.

To read test weight #1 from the IND131/IND331:

- The master writes 602(dec) to 40009.
- Read 40011, if 40011 is equal to 602(dec), 40010 is reporting test weight #1.

To read test weight #2 from the IND131/IND331:

- The master writes 604(dec) to 40009.
- Read 40011, if 40011 equals to 604, 40010 will report test weight #2.

Calibrating the Scale via Modbus RTU

The IND131/IND331 can be calibrated via the Modbus RTU interface. The terminal supports 2-point (linearity disabled) and 3-point (linearity enabled) calibration.

Zero Adjustment

1. Clear 40007
2. Write 026 (dec) to 40009 to read the calibration status, the calibration status will be reported in 40010 as follows:
 - 0 – adjustment OK
 - 1 – adjustment in progress
 - 10 (dec) – adjust in dynamic
 - 255 (dec) – adjustment failure
3. Write 1 to 40008
4. Write 40 (dec) to 40007 to trigger zero adjustment

Span #1 Calibration

1. Clear 40007.
2. Write test weight #1 (Integer or Division format) to 40008.
3. Write 602(dec) to 40007. This is the trigger to write the value in 40008 to the IND131/IND331 SPAN #1 test weight register.
4. Clear 40007.
5. Write 026 (dec) to 40009 to read calibration status, the calibration status will be reported in 40010
6. Write 1 to 40008.
7. Write 41 (dec) to 40007. This writes the value in address 40008 to the IND131/IND331 start SPAN 1# adjustment trigger.

Span #2 Calibration

1. Clear 40007.
2. Write test weight #2 (Integer or Division format) to 40008.

3. Write 604 (dec) to 40007. This is the trigger to write the value in 40008 to SPAN #2 test weight.
4. Clear 40007.
5. Write 026 to 40009 to read the calibration status.
6. Write 1 to 40008.
7. Write 42 to 40007. This writes the value in address 40008 to the IND131/IND331 start SPAN #2 adjustment trigger.

Read test weight #1

1. Write 602 (dec) to 40009.
2. Check 40011, if 40011 equals to 602 (dec), 40010 reports test weight #1.

Read test weight #2

1. Write 604 to 40009.
2. Check 40011, if 40011 equals to 604 (dec), 40010 is reports test weight #2

Controlling the Discrete I/O

The IND131/331 terminal provides the ability to directly control three of its discrete outputs and read both of its discrete inputs via the (digital) PLC interface options. System integrators should be aware that the terminal's discrete I/O updates are synchronized with the terminal's interface update cycle rate and not with the PLC I/O scan rate. This may cause a noticeable delay in reading inputs or updating outputs as observed from the PLC to real world signals. Consult the IND131/331 Terminal Technical Manual for discrete I/O wiring. Also note that the outputs must be assigned as 'None' in the terminal setup.

Wiring

The Modbus RTU connection to the IND131 and IND331 terminals must use the COM2 port and can be made with either RS-232 (single point-to-point connection) or RS-485 (multi-drop connection). The COM2 port is identified in Figure 2-1 and Figure 2-2 on the COM2/DIO option board. The wiring configuration for a single point-to-point RS-232 connection is shown in Figure 2-3 and the multi-drop RS-485 connection is shown in Figure 2-4.

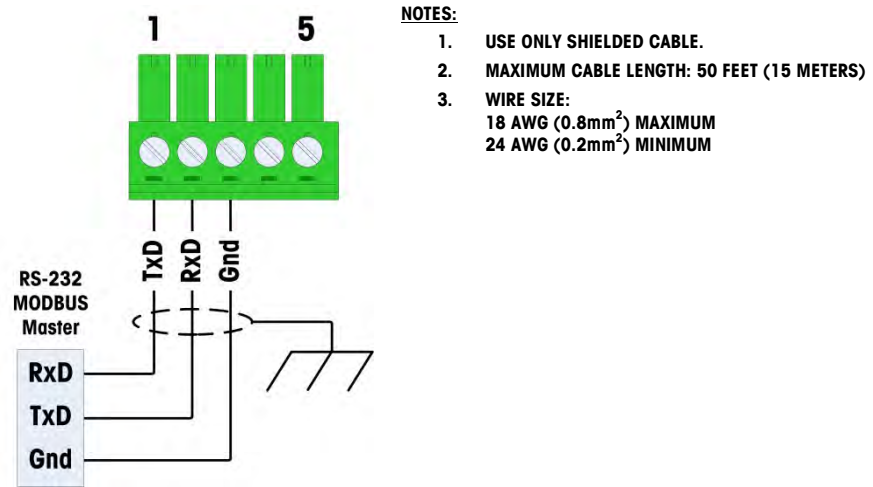

Figure 2-3: RS-232 Wiring Example to COM2

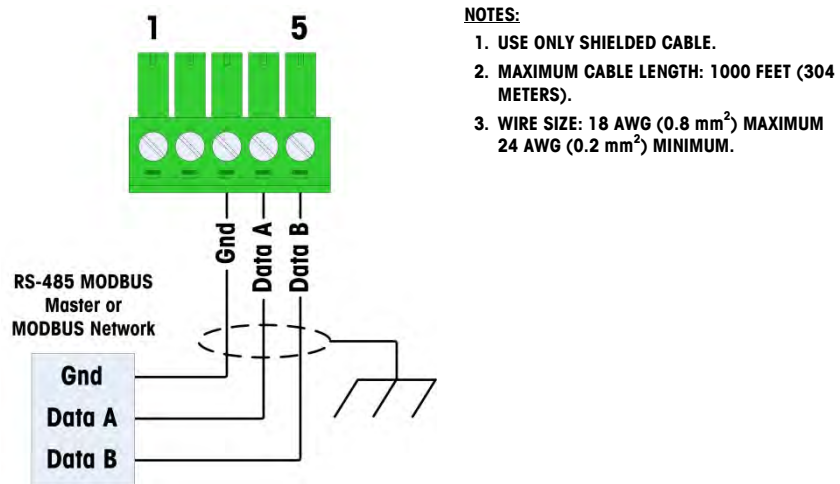

Figure 2-4: RS-485 Wiring Example to COM2

- Note that both ends of an RS-485 network must have a 150Ω termination resistor added. This resistor is not supplied by METTLER TOLEDO.

Several documents are available from the Modbus organization to help with the planning and implementation of a Modbus network. One such document is Modbus Over Serial Line - Specification and Implementation Guide available from the Modbus organization's web site at <http://www.modbus.org/>. This document describes how to connect the Modbus network, and includes information about restrictions associated with the serial interface. METTLER TOLEDO recommends that this document be read and understood before attempting to create a Modbus network.

Software Setup

In order to program the IND131 and IND331 terminals for a Modbus RTU connection, the setup mode of the terminal must be accessed. The Modbus RTU programming steps are located at Communication > Connections and Communication > Serial. Figure 2-5 graphs the associated program blocks.

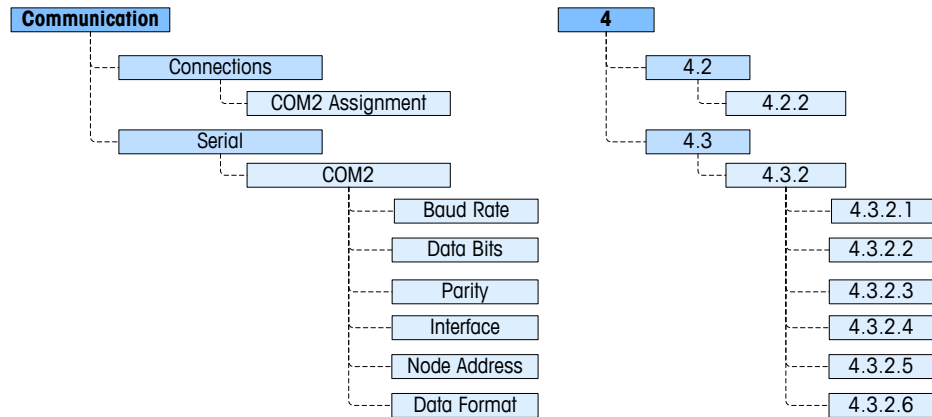

Figure 2-5: Modbus RTU Program Blocks

In this section, figures given in brackets (e.g. [7]) correspond to the parameter options available when F-codes are displayed by the terminal.

Connections Sub-Block

This block lets you assign the functionality for COM2 as Modbus RTU.

Hardware Setup

Connections COM2 – F4.2.2

The COM2 connection assignment is selected from a list, which includes the following options: None [0], Continuous Output [1], Continuous-Extended Output [2], Demand Output [3] (the default), SICS [4] and Modbus RTU [7] (COM2 only).

Select Modbus RTU [7] as the assignment for COM2.

Serial Sub-Block

This block lets you program the communication parameters for the COM2 port, assign a Modbus RTU node address and select the data format.

- Note that there is no setup parameter for the number of stop bits. Only 1 stop bit is supported.

Baud Rate

Use the Baud Rate selection menu to set the baud rate for the serial port. Options are:

300 [0]	1200 [2]	4800 [4]	19200 [6]	57600 [8]
600 [1]	2400 [3]	9600 [5]	38400 [7]	115200 [9]

The default is 9600 baud.

Data Bits

Use the Data Bits menu to select the number of data bits to be used on the serial port – options are **7 [0]** or **8 [1]** (the default).

Parity

Use the Parity menu to set the parity for COM2. Choices are **None [0]** (the default), **Odd [1]**, or **Even [2]**. This implementation of Modbus RTU requires selection of either Even or Odd parity and because of this, only 1 stop bit is supported.

Interface

The COM2 port must be set to **RS-232 [0]** (the default) when connecting to an RS-232 device or set to **RS-485 [1]** when connecting to an RS-485 network.

Modbus RTU Node

Each IND131/IND331 represents a physical RTU node. The node is chosen by the system designer, and then programmed into the terminal. The node address must be unique for each IND131/331 terminal.

Enter the desired node address in the range from 000 to 255. The default value is 000.

Data Format

The format of numerical data sent to and from the IND131/IND331 terminal can be selected as either an **Integer value [0]** (the default) or as the number of display **Divisions [1]**. Selection of the appropriate format depends on issues such as the range or capacity of the scale used in the application. The integer format represents a numerical value up to ± 32767 . The division format can represent a value up to ± 32767 scale divisions or increments.

Integer and division formats ignore decimal points. Accommodation of decimal point location must take place in the PLC logic, when it is needed with these formats.

Examples

250 x 0.02 scale				
IND131/IND331 Displays:	0	2.00	51.68	250.00
Data sent:				
Integer	0	200	5168	25000
Division	0	100	2584	12500

Any of the formats could be used in this case.

50,000 x 10 scale				
IND131/IND331 Displays:	0	200	5160	50000
Data sent:				
Integer	0	200	5160	-(15536)
Division	0	20	516	5000

The integer format could not be used as it would send a negative value once the weight exceeded 32,767.

100 x 0.001 scale				
IND131/IND331 Displays:	0	2.100	51.607	90.000
Data sent:				
Integer	0	2100	-(13929)	(24464)
Division	0	2100	-(13929)	(24464)

Neither format could be used as they would send a negative value when the weight exceeded 32.767.

Troubleshooting

If the IND131 or IND331 terminal does not communicate with the PLC, do the following:

- Check wiring and network termination. Refer to the Modbus Over Serial Line - Specification and Implementation Guide available from the Modbus organization's web site at <http://www.modbus.org/>.
- Confirm that the terminal settings for COM2 Assignment and the serial port parameters match those in the PLC and that each IND131 and IND331 terminal has a unique address.
- If neither of the checks above resolves the issue, contact a METTLER TOLEDO authorized service location.

Chapter 3

A-B RIO Option

Overview

This chapter covers

- Overview
- Data Formats
- Hardware Setup
- Software Setup
- Troubleshooting
- Interfacing Examples

The A-B RIO option enables the IND131/IND331 terminal to communicate to Allen-Bradley Programmable Logic Controllers (PLCs) through direct connection to the A-B RIO network. The option consists of an I/O module and software that resides in the IND131/IND331 terminal, which implements the data exchange.

The A-B RIO option has the following features:

- A-B RIO Node Adapter Chip Set (licensed from Allen-Bradley) and termination for the A-B network cable (blue hose) on a three-position removable terminal block.
- User programmable RIO communication parameters are configured in software set up through the terminal keyboard/display. The parameters are as follows:
 - 57.6K, 115.2K, or 230.4K baud rate
 - 1/4 rack for discrete or integer formats and 1/2 rack for floating point format
 - Rack address
 - Starting quarter
 - Last rack designation
- Capability for bi-directional discrete mode communications of weight, display increments, status, and control data between the PLC and the terminal.

Figure 3-1 shows an A-B RIO option board, with its connector at lower left.



Figure 3-1: A-B RIO Option Board

Communications

The IND131/IND331 terminal utilizes component parts that are provided by Allen-Bradley to ensure complete compatibility with the Allen-Bradley RIO network. An IND131/IND331 terminal is recognized as an RIO (Allen-Bradley) device by the PLC.

Each option connected to the Allen-Bradley RIO network represents a physical node. The connection is facilitated by a three-position removable terminal block on the option card. These terminals correspond to the terminals on the A-B PLC RIO connector.

The wiring between the PLC and the RIO connector uses the standard RIO cable used by Allen-Bradley (Figure 3-2). This cable is often referred to as the “blue hose.” The cable installation procedures and specification including distance and termination requirements are the same as recommended by Allen-Bradley for the RIO network.

The IND131/IND331 terminal’s baud rate is programmed through Communication > PLC > A-B RIO in the setup menu.

Node/Rack Address

Although each RIO option represents one physical node, the addressing of the node is defined as a logical rack address. This address is chosen by the system designer, and then programmed into the terminal and PLC. The IND131/IND331 terminal’s address is programmed through Communication > PLC > A-B RIO in the setup menu. IND131/IND331 address entry is in decimal, the PLC address entry will be in octal or hexadecimal.

The IND131/IND331 terminal’s setup capabilities allow selection of the logical rack address, starting quarter, and designation of the last rack.

Data Formats

The A-B RIO option has three data formats: Integer, Divisions, and Floating Point. Refer to Appendix A, **Data Definition**, for details on these formats.

Discrete data is continuously available. The block transfer mode of operation is not supported in the IND131 and IND331 terminals.

Hardware Setup

Wiring

The IND131/IND331 terminal's A-B RIO option card uses a three-position removable terminal strip to connect to the A-B RIO network interface (Figure 3-2). Cable distance, type, and termination are specified by Allen-Bradley (See Allen-Bradley documentation for reference on cable design guidelines for the various PLCs). Mettler-Toledo recommends Belden 9463 cable.

- The 3-position connector comes with the RIO option kit.

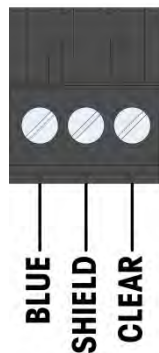

NOTES:

1. CONNECTION WITH TWIN AXIAL CABLE (BLUE HOSE) SHOWN.
2. REFER TO ALLEN-BRADLEY REMOTE I/O DOCUMENTATION FOR TERMINATION RESISTOR AND OTHER CONSIDERATIONS.
3. WIRE SIZE: 14 AWG (2.0 mm²) MAXIMUM
22 AWG (0.3 mm²) MINIMUM.

Figure 3-2: Three-Position Terminal Strip Wiring

Software Setup

The IND131/IND331 terminal automatically detects the presence of an A-B RIO option board if one is installed. When detected, the IND131/IND331 terminal adds the Allen-Bradley parameters in a program block under Communication > PLC. You can configure these parameters just as you configured the other blocks. Figure 3-3 graphs the A-B RIO program block.

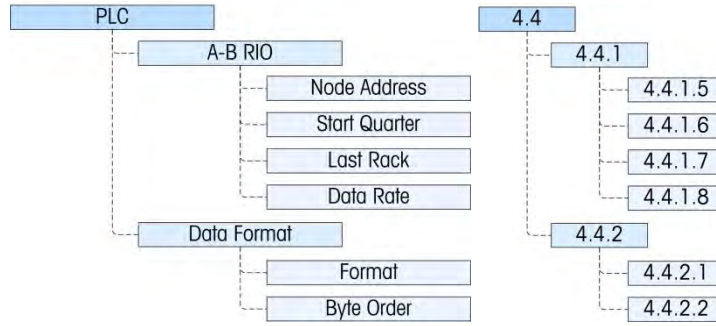

Figure 3-3: A-B RIO Program Block

In this section, figures given in brackets (e.g. [0]) correspond to the parameter options available when F-codes are displayed by the terminal.

A-B RIO Setup Sub-Block

This block lets you specify how the RIO interface is used. Several options are available to correspond with your system setup.

A-B RIO Setup – F4.4.1

This node provides access to the A-B RIO setup block.

Node Address – F4.4.1.5

Each IND131/IND331 Terminal connected to the network represents one physical node. This address is determined by the system designer, then configured in the terminal by entering the decimal Node Address from 0 to 62 (default is 001).

Start Quarter – F4.4.1.6

Program the starting quarter location within the rack space. Start Quarter options are 1 (default), 2, 3 and 4 [1, 2, 3, 4].

Last Rack -- F4.4.1.7

Last Rack can be set to **Enable** [1] or **Disable** [0] (the default).

Data Rate – F4.4.1.8

Select the data baud rate – options are 57600 [0] (the default), 115200 [1] and 230400 [2].

Data Format Setup – F4.4.2

Format – F4.4.2.1

From this menu, select a data format for the A-B Rio terminal. The choices are **Division [0]**, **Floating Point [1]**, and **Integer [2]**:

Division – displays scale weight in display divisions. The PLC multiplies the display divisions by the increment size to calculate the weight in display units.

Floating Point – displays weight in floating point data format

Integer – displays scale weight as a signed 16 bit integer (± 32767)

Byte Order – F4.4.2.2

Select the Byte Order from **Byte Swap [0]**, **Historic [1]** (the default) and **Word Swap [2]**.

- **Byte Swap** – Makes the floating point format compatible with S7 PROFIBUS.
- **Historic** – Makes the data format compatible with PLC5.
- **Word Swap** – Takes the IEE 754 single-precision floating point format and swaps the two words in the 32-bit double word. This format is compatible with RSLogix 5000 processors.

Refer to Appendix A, **Data Definition**, for additional information on byte order and data format.

Troubleshooting

Procedure

If the IND131/IND331 does not communicate with the PLC do the following:

- Check wiring and network termination.
- Confirm that the IND131/IND331 settings for data type and rack assignment match what are in the PLC.
- If neither of the checks above resolves the issue, contact an authorized service location of METTLER TOLEDO

Interfacing Examples

The remaining Figures show sample screens from ladder logic programming examples for RSLogix 5000 software. The documentation CD part number 64067499 contains complete versions of these.

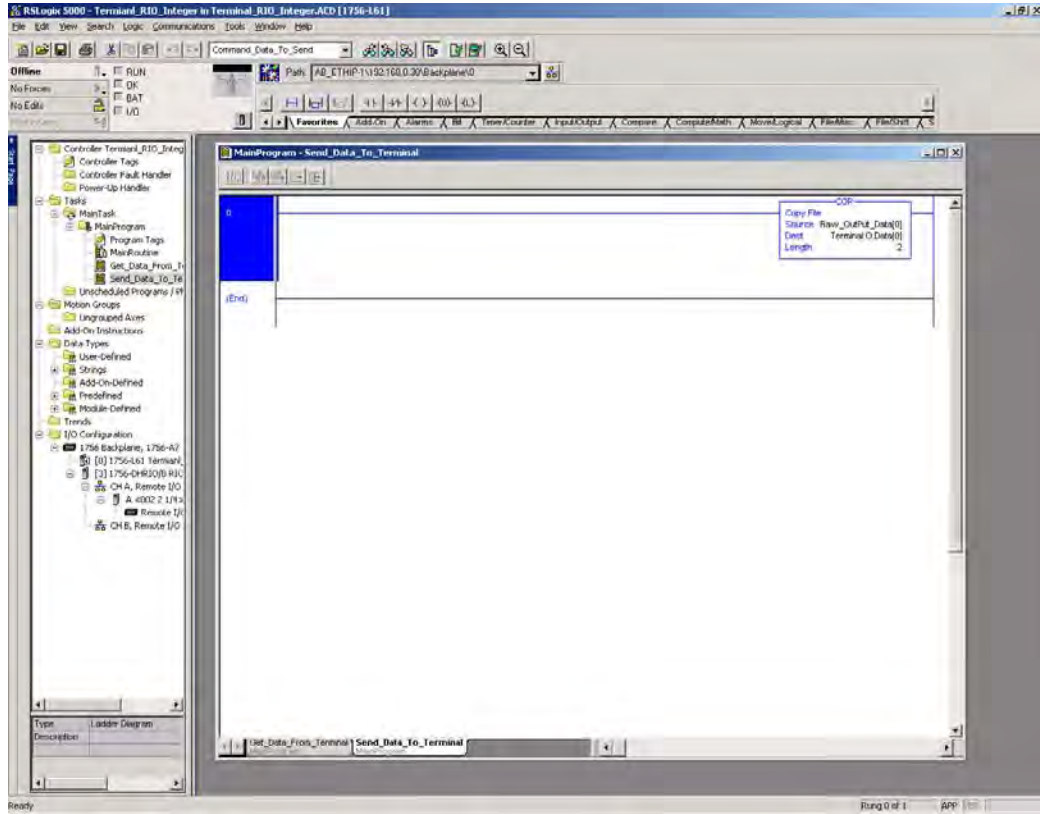

Figure 3-4: Integer/Division Data, PLC to Terminal

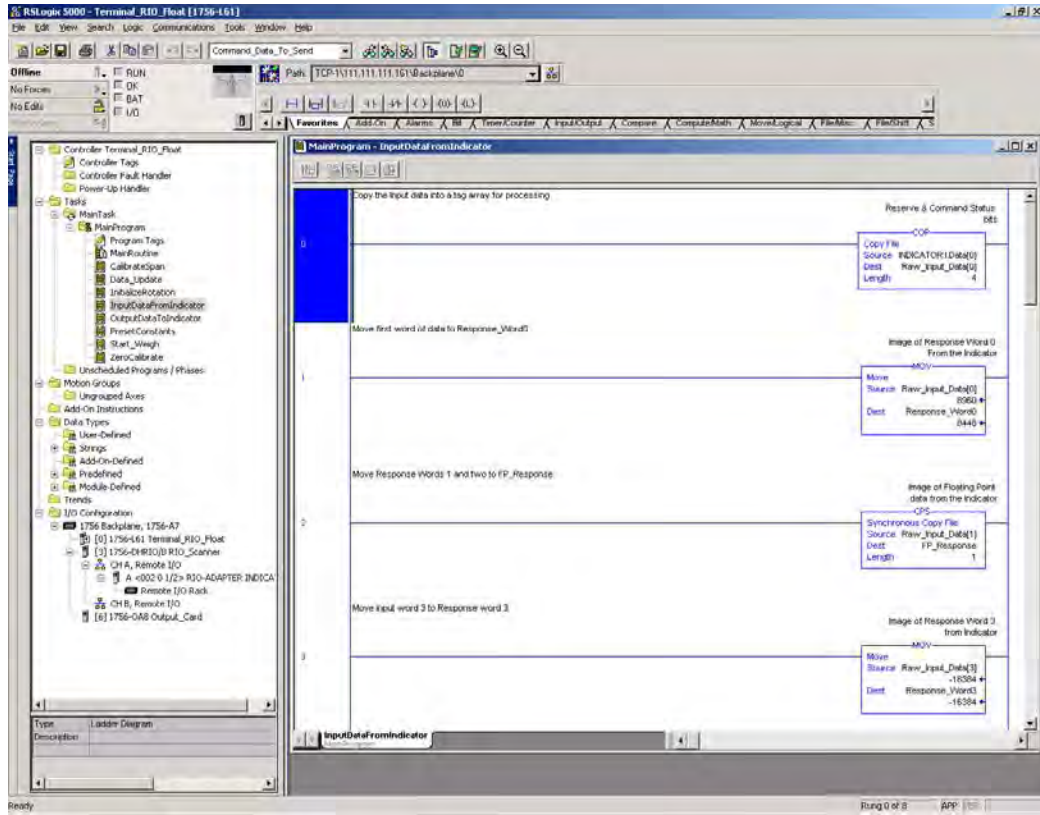

Figure 3-5: Floating Point Data, Terminal to PLC

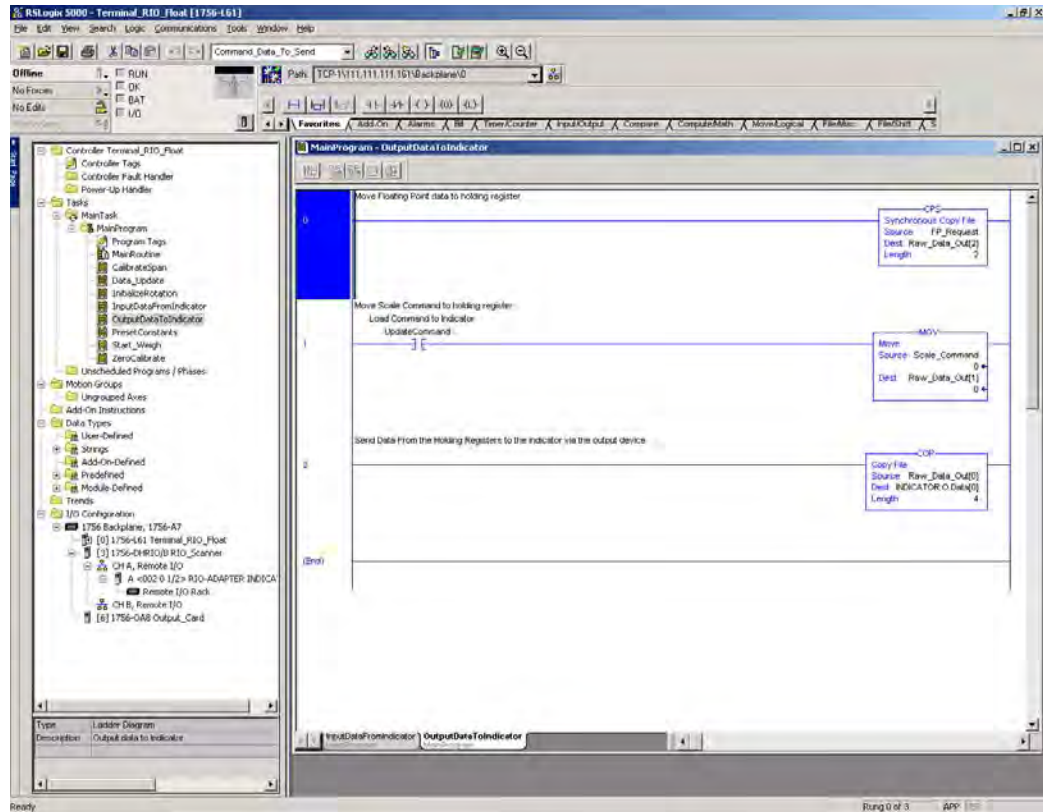

Figure 3-6: Floating Point Data, PLC to Terminal

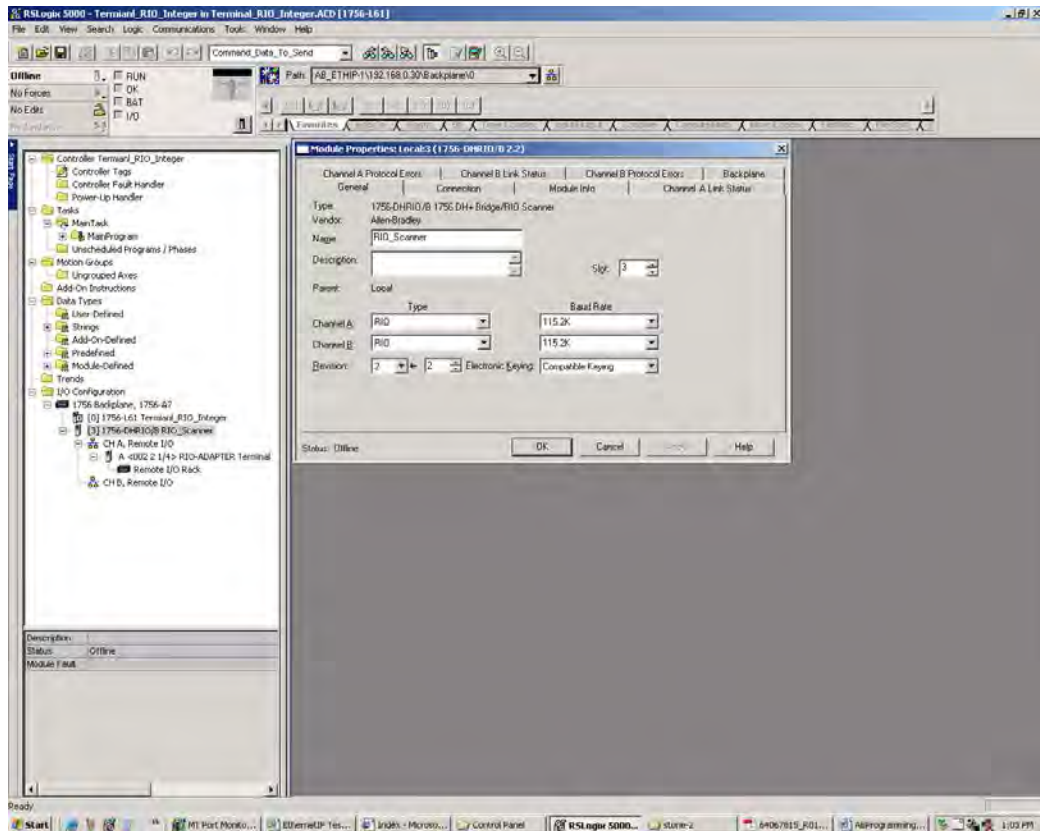

Figure 3-7: RSLogix 5000, Integer/Divisions Scanner Configuration (Screen 1)

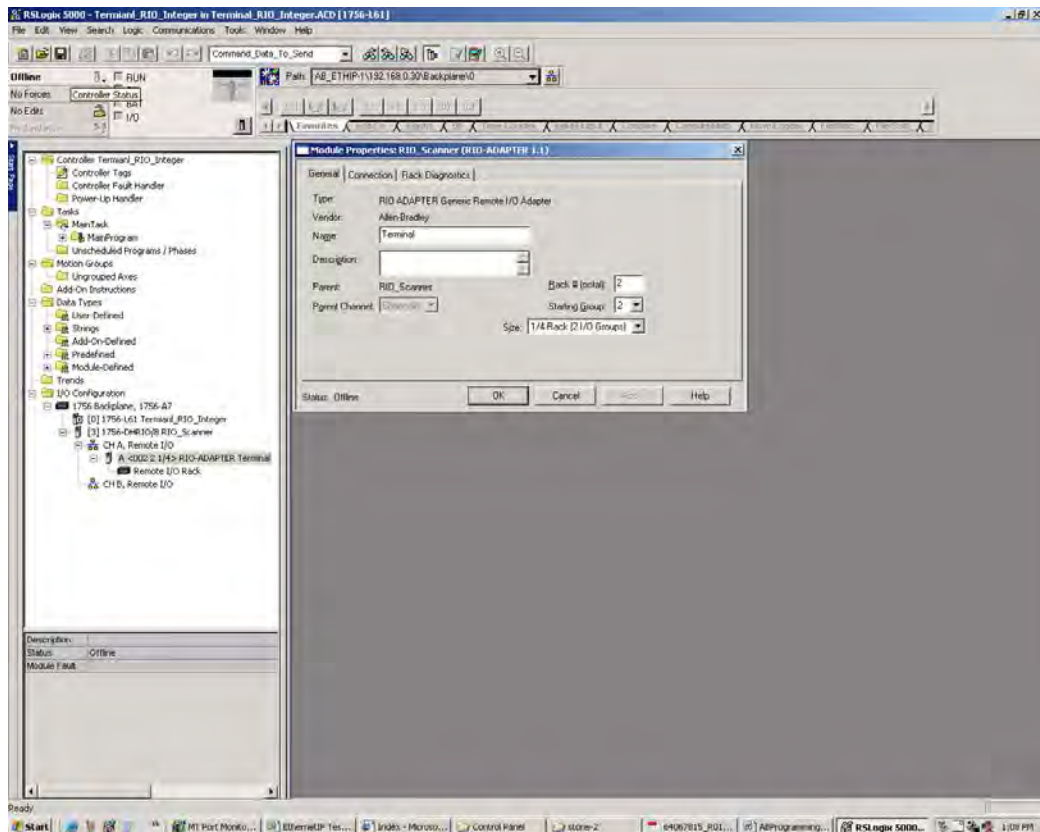

Figure 3-8: RSLogix 5000, Integer/Divisions Scanner Configuration (Screen 2)

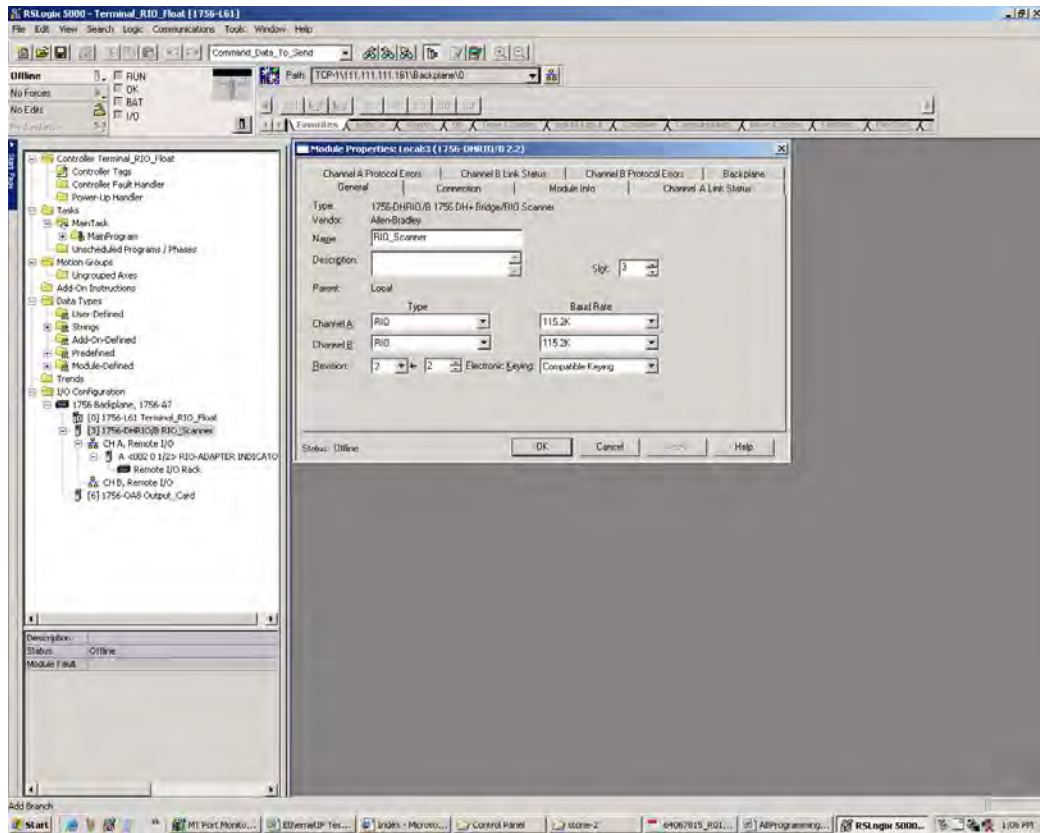

Figure 3-9: RSLogix 5000, Floating Point Scanner Configuration (Screen 1)

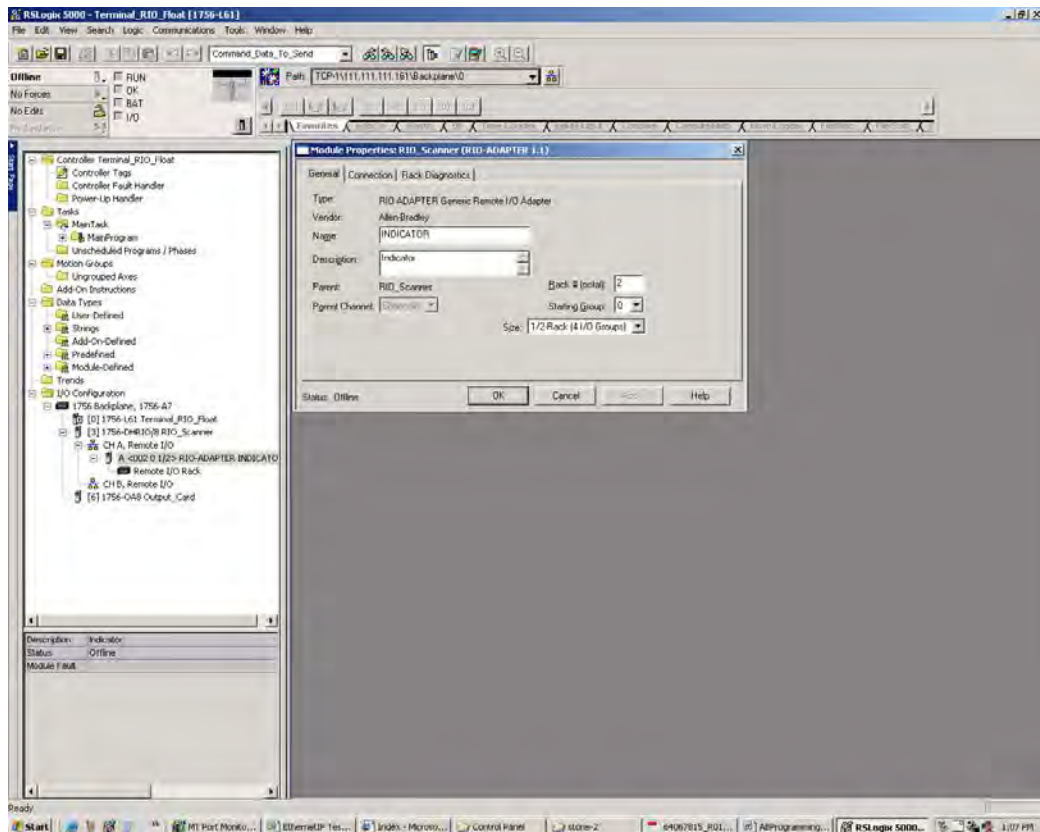

Figure 3-10: RSLogix 5000, Floating Point Scanner Configuration (Screen 2)

Chapter 4

ControlNet Option

Overview

This chapter covers

- Overview
- Data Definition
- Hardware Setup
- Software Setup
- Troubleshooting
- Programming Examples

The ControlNet option enables the IND131/IND331 terminal to communicate to ControlNet Programmable Logic Controllers (PLCs) through direct connection to the ControlNet network. The kit consists of an I/O module and software that resides in the IND131/IND331 terminal to implement the data exchange. Figure 4-1 shows the ControlNet module and its components.

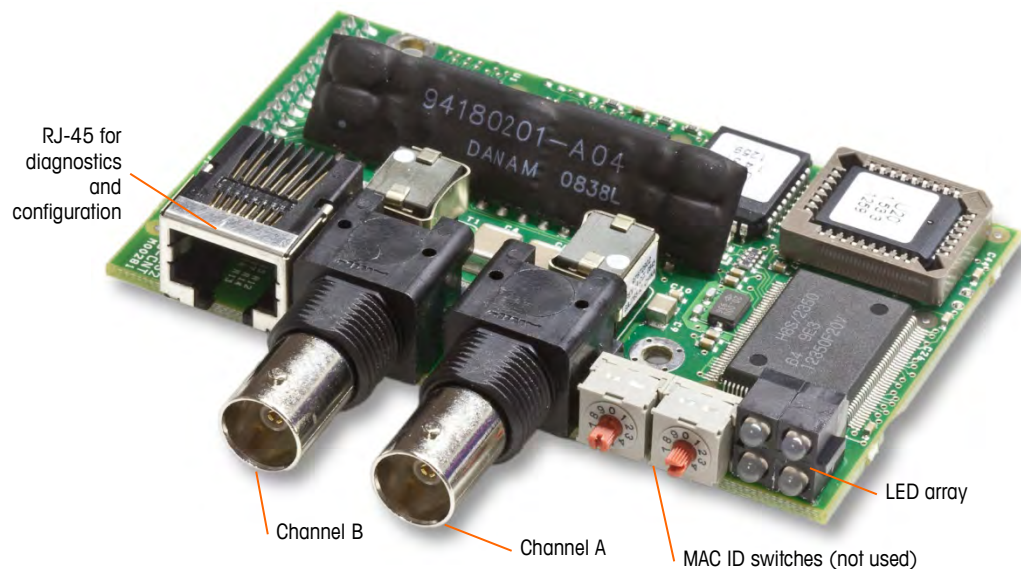

Figure 4-1: ControlNet PLC Module and its Components

- Do **not** plug an Ethernet cable into the RJ-45 connector shown at left in Figure 4-1. This connection is not used.

The ControlNet option has the following features:

- User-programmable node (MAC ID) address.
- Capability for bi-directional discrete mode communications (Class 1 Messaging) of weight or display increments, status, and control data between the PLC and the IND131/IND331.

Definition of Terms

Some terms (such as Target) used by the ControlNet PLC application have a different meaning from their use by the IND131/IND331 terminal. Table 4-1 offers definitions specific to ControlNet.

Table 4-1: ControlNet Definition of Terms

Term	Definition
Adapter Class	An Adapter Class product emulates functions provided by traditional rack-adapter products. This type of node exchanges real-time I/O data with a Scanner Class product. It does not initiate connections on its own.
Class 1 Messaging	In ControlNet communication protocol scheduled (cyclic) message transfer between a PLC and CIP Adapter Class device.
Class 3 Messaging	This class is not supported by the IND131/IND331.
Connected Messaging	A connection is a relationship between two or more application objects on different nodes. The connection establishes a virtual circuit between end points for transfer of data. Node resources are reserved in advance of data transfer and are dedicated and always available. Connected messaging reduces data handling of messages in the node. Connected messages can be Implicit or Explicit. See also Unconnected Messaging .
Connection Originator	Source for I/O connection or message requests. Initiates an I/O connection or explicit message connection.
Explicit Messaging	Explicit Messaging is not supported by the IND131/IND331.
Implicit Messaging	Implicit Messages are exchanged across I/O Connections with an associated Connection ID. The Connection ID defines the meaning of the data and establishes the regular/repeated transport rate and the transport class. No messaging protocol is contained within the message data as with Explicit Messaging. Implicit Messages can be point-to-point or multicast and are used to transmit application-specific I/O data. This term is used interchangeably with the term I/O Messaging .
I/O Client	Function that uses the I/O messaging services of another (I/O Server) device to perform a task. Initiates a request for an I/O message to the server module. The I/O Client is a Connection Originator.
I/O Messaging	Used interchangeably with the term Implicit Messaging .

Term	Definition
I/O Server	Function that provides I/O messaging services to another (I/O Client) device. Responds to a request from the I/O Client. I/O Server is the target of the connection request.
Message Client	Function that uses the Explicit messaging services of another (Message Server) device to perform a task. This is not supported in the IND131/IND331.
Message Server	Function that provides Explicit messaging services to another (Message Client) device. This is not supported in the IND131/IND331.
Scanner Class	A Scanner Class product exchanges real-time I/O data with Adapter Class and Scanner Class products. This type of node can respond to connection requests and can also initiate connections on its own.
Target	Destination for I/O connection or message requests. Can only respond to a request, cannot initiate an I/O connection or message.
Unconnected Messaging	Unconnected Messaging is not supported in the IND131/IND331.

Communications

The IND131/IND331 terminal uses component parts that ensure complete compatibility with the Allen-Bradley ControlNet network. An IND131/IND331 terminal is recognized as a generic ControlNet device by the PLC.

Each ControlNet option connected to the ControlNet network represents a physical node. The connection is made using BNC connectors on the option card.

The wiring between the PLC and the IND131/IND331 ControlNet connection uses RG-6 CATV cable and 75 ohm impedance matching transformer tap for each node. The cable is commonly referred to as coaxial cable. The cable installation procedures and specification including distance and termination requirements are the same as recommended by Allen-Bradley for the ControlNet network. The normal connection is to the channel A connector. The channel B connector is only used for redundant connection networks.

The IND131/IND331 terminal's communication update rate is set up by the use of Allen Bradley software Network for ControlNet.

The IND131/IND331 uses Class 1 cyclic data for discrete data transfer.

Node Address

Each ControlNet option represents one physical node. This address is chosen by the system designer, and then programmed into the IND131/IND331 terminal and PLC. The IND131/IND331 terminal's address is programmed in setup at Communication > PLC Interface > ControlNet. The IND131/IND331 address entry is in decimal.

Data Formats

The ControlNet option provides discrete data transfer, Class 1 messaging. Discrete data is continuously available. The ControlNet option has its own logical node address to send and receive information to and from the PLC. There are three data formats: Integer, Divisions, and Floating Point. Refer to Appendix A, **Data Definition**, for further information.

Data Definition

Assembly Instances of Class 1 Cyclic Communications

Class 1 cyclic communications is used for transfer of Discrete Data between the PLC and the IND131/IND331.

The PLC Input Assembly Instance is 100 (decimal). This instance is used for all Data Formats and data size requirements.

The PLC Output Assembly Instance is 150 (decimal). This instance is used for all Data Formats and data size requirements.

The IND131/IND331 uses data only; no configuration data is used or required. Within the PLC ControlNet Interface setup set the Configuration Instance to 1 and the data size to zero.

The EDS file provided on the Documentation CD has no Assembly Instance or data size limitations. The IND131/IND331 programming controls the Assembly Instance and data size limitations.

Hardware Setup

Wiring

The ControlNet PLC Module connects to the ControlNet network via a tap and drop cable from the original trunk cable. The option supports one BNC coaxial connection or two (for redundancy). Channel A is the normal connection and Channel B (redundant with Channel A) can be used if ControlNet detects no signal on Channel A. Refer to Figure 4-2.

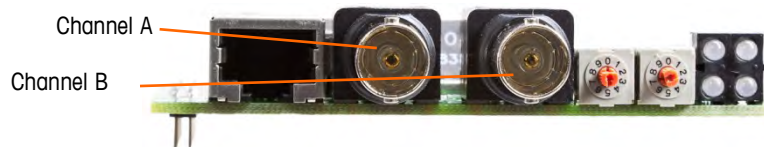

Figure 4-2: Coaxial Connector for ControlNet

Figure 4-3 shows examples of two different ControlNet tap and drop cables. Note that the connector to the ControlNet option may be straight or right-angled, as seen here. The DIN and panel-mount enclosures can use either type of drop cables. The harsh and J-Box enclosure types must use the straight connector version of drop cable. This drop cable is not supplied by METTLER TOLEDO.

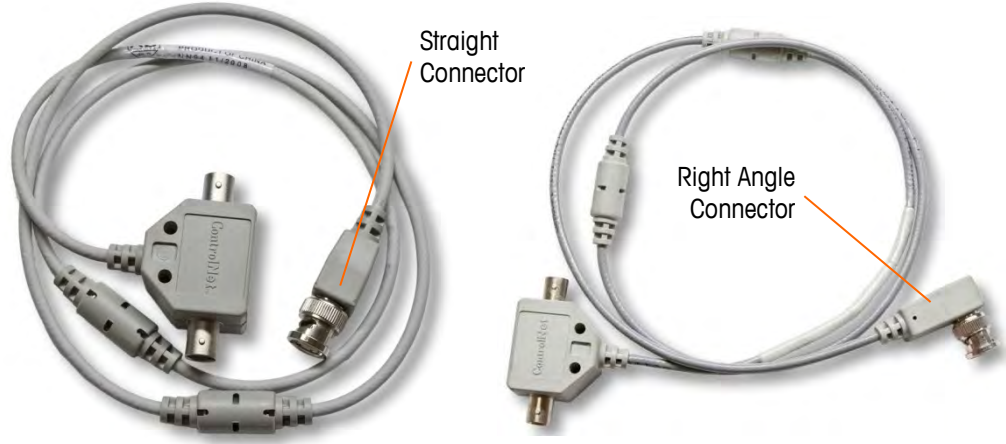

Figure 4-3: ControlNet Tap and Drop Cables

Cable distance, type, and termination are specified by Allen-Bradley (Refer to the Allen-Bradley documentation for cable design guidelines for the various PLCs). More wiring details are provided in the IND131 and IND331 **Installation Manual**.

Software Setup

The IND131/331 terminal automatically detects the presence of a ControlNet option board if one is installed. When detected, the IND131/331 terminal adds the ControlNet parameters in a program block under Communication > PLC. Figure 4-4 shows the ControlNet program block.

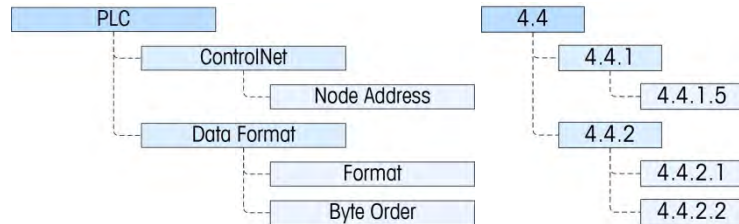

Figure 4-4: Setup Menu for ControlNet

In this section, figures given in brackets (e.g. [7]) correspond to the parameter options available when F-codes are displayed by the terminal.

ControlNet Setup Sub-Block

This block lets you specify how the ControlNet interface is used. Several options are available to correspond with your system setup.

ControlNet Setup – F4.4.1

Provides access to the node address for the terminal. Note that the network baud rate is automatically determined by the terminal.

Node Address – F4.4.1.5

Each IND131 or IND331 Terminal connected to the network represents one physical node. This address is determined by the system designer, then configured in the terminal by entering the appropriate number (0 to 99 (the default)) in the Node Address menu.

Data Format – F4.4.2

Provides access to the Format and Byte Order parameters.

Format – F4.4.2.1

The Format menu allows a data format to be selected from a list. Options are **Division [0]**, **Floating Point [1]** and **Integer [2]** (the default).

Byte Order – F4.4.2.2

This parameter selects the order in which the data bytes and words will be presented in the PLC data format. The choices are **Byte Swap [0]**, **Standard [1]**, **Word Swap [2]** (the default) and **Double Word Swap [3]**.

- **Byte Swap** makes the floating point format compatible with S7 PROFIBUS.
- **Standard** makes the floating point format compatible with PLC 5.
- **Word Swap** takes the IEE 754 single-precision floating point format and swaps the two words in the 32-bit double word. This format is compatible with RSLogix 5000 processors.
- **Double Word Swap** takes the IEE 754 single-precision floating point format and swaps the two words plus byte swaps in the 32-bit double word. This format makes floating point data compatible with Modicon Quantum processors.

Troubleshooting

The ControlNet option board has a four LED array that indicates the state of the communication. Figure 4-5 shows the array of the status indicator LEDs with each LED labeled.



Figure 4-5: ControlNet Status Indicator LEDs

Table 4-2 describes the different conditions of the LEDs.

Table 4-2: ControlNet Status Indications

LED	LED State	Description
Module Status	Green	Connection in Run state
	Green, flashing	Connecting Connection Idle
	Red	Major fault
	Red, flashing	Minor fault
Channel A <i>And</i> Channel B	Off	Module not initialized
	Red	Major fault
	Alternating red/green	Self test
	Red, flashing	Node configuration error; duplicate MAC ID, etc.
Channel A <i>or</i> Channel B	Off	Channel disabled
	Green	Normal operation of channel
	Green, flashing	Temporary error (node will self-correct) or not configured
	Red, flashing	No other nodes, or media fault
	Red & green, flashing	Network configuration error
Module Owned	Off	No connection has been opened
	Green	A connection has been opened towards the module

Procedure

If the IND131/IND331 does not communicate with PLC, do the following:

- Check wiring and network termination.
- Confirm that the IND131/IND331 settings for data type and node assignment match those in the PLC and that each IND131/IND331 has a unique node assignment.
- If neither of the checks above resolves the issue, contact an authorized service location of METTLER TOLEDO.

Programming Examples

This section provides screen images of ladder logic programming examples for RSLogix 5000 software.

Note: The Utilities folder of the documentation CD (part number 64057241) contains complete versions of the examples. These screen images are provided for illustrative purposes only.

These screens only show an example of a particular Input and Output size configuration. The Connection Parameters I/O sizes must be appropriately configured for the data format selected.

Integer/Divisions

Table 4-3 shows the relationship between the IND131/IND331 data format and the RSLogix 5000 I/O sizing for Integer and Division data formats.

Table 4-3: PLC I/O Sizes (Integer/ Division)

16 Bit Word	
IND131/IND331 >> PLC Input	PLC Output >> IND131/IND331
4	2

Note that the input data size is 4 words. The IND131/IND331 data is mapped to the last two words of the block.

Checking Module Properties

First, check the node setting. Right-click on **CONTROLNET MODULE IND131_331_Terminal**, and select **Properties**.

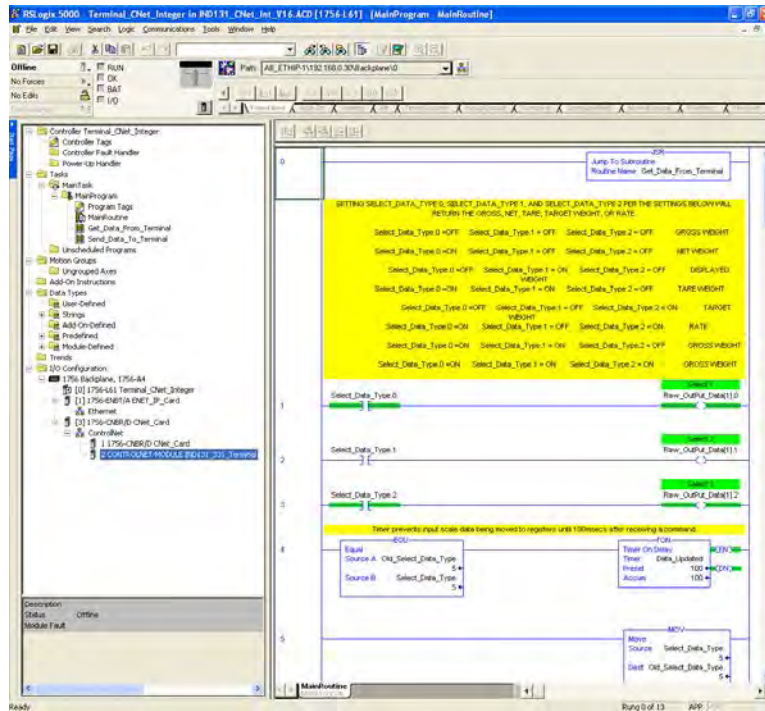

Figure 4-6: RSLogix – Checking Node Setting

A Module Properties dialog will appear, with its **General** tab displayed.

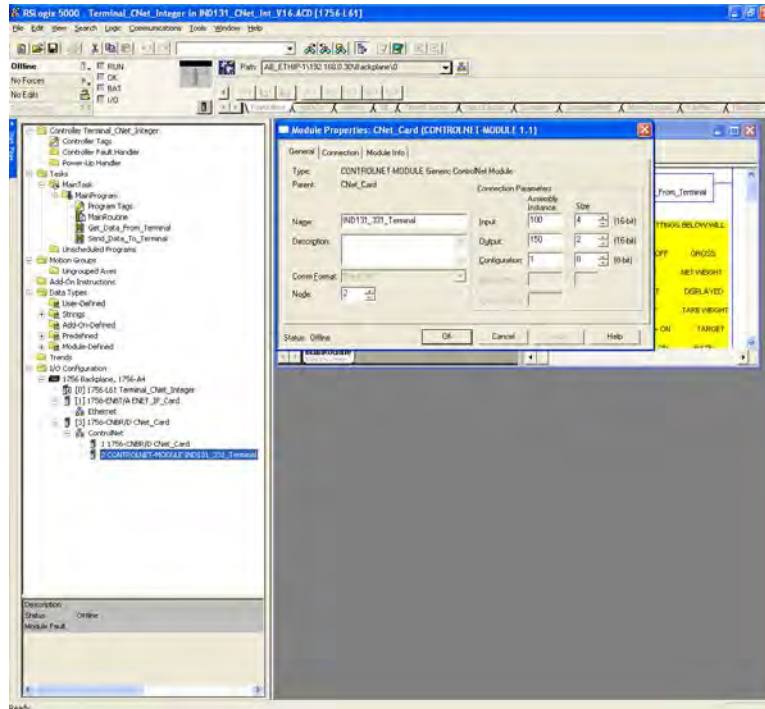

Figure 4-7: RSLogix – Module Properties, General Tab

Verify that the node shown matches the IND131/IND331 node, and click OK.

Scheduling the ControlNet Network

Now the ControlNet network must be scheduled. Right-click 1756-CNBR/D CNet_Card and select Properties.

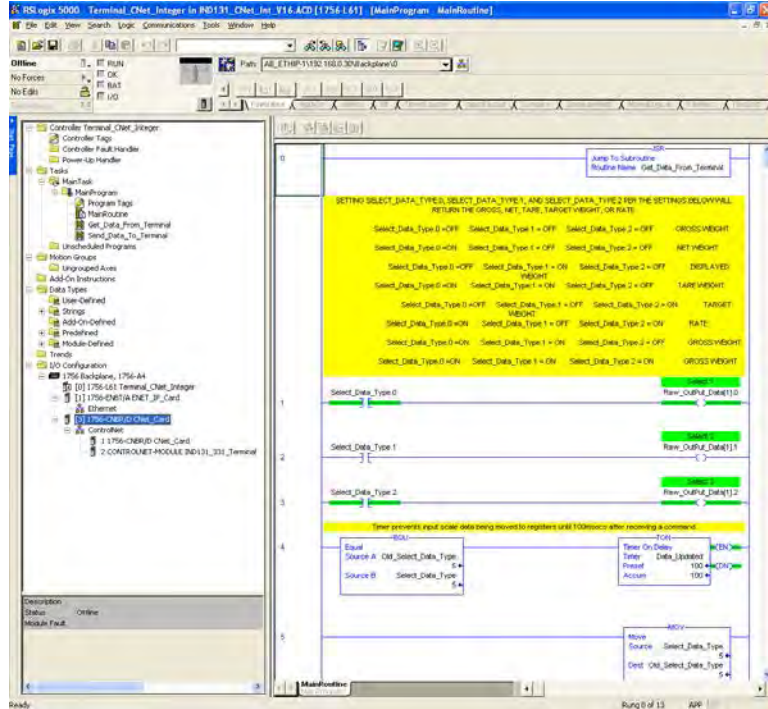

Figure 4-8: RSLogix – Scheduling ControlNet Network

In the Properties dialog, click the **RSNetworkx** tab and enter the name of the ControlNet file, if it is not already there. Click **Apply**, then click the large button at left in the dialog, to open the RSNetworkx window (Figure 4-10).

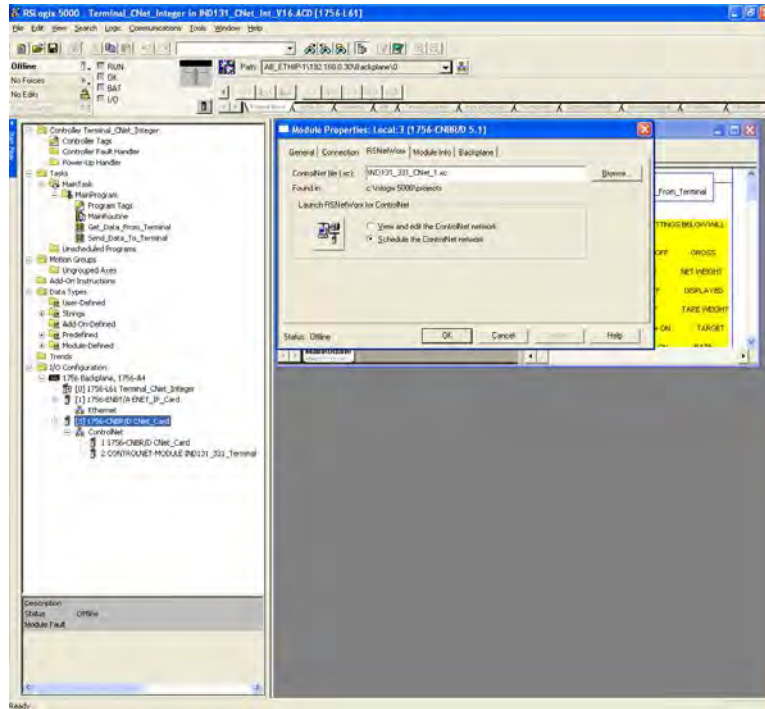

Figure 4-9: RSLogix – Module Properties, RSNetworkx Tab

Before the IND131/IND331 can be scheduled, the EDS file for the terminal must be registered. To do this in RSNetworkx, select **Tools | EDS Wizard** from the menu bar.

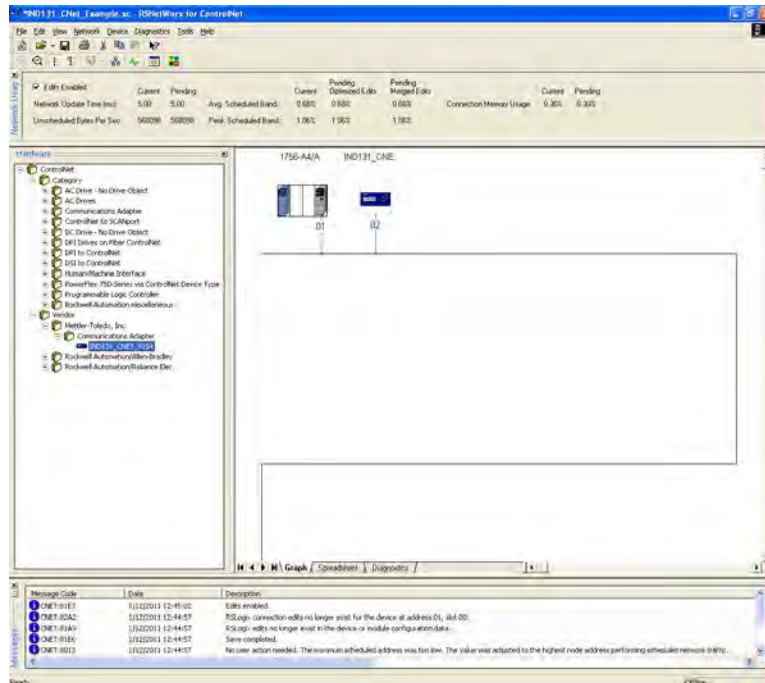

Figure 4-10: RSNetworkx Window

The EDS Wizard window will open.



Figure 4-11: EDS Wizard – Welcome Screen

Click **Next**.

The Wizard's **Options** screen shows the **Register an EDS file(s)** option selected by default.



Figure 4-12: EDS Wizard Welcome Screen

Click **Next**.

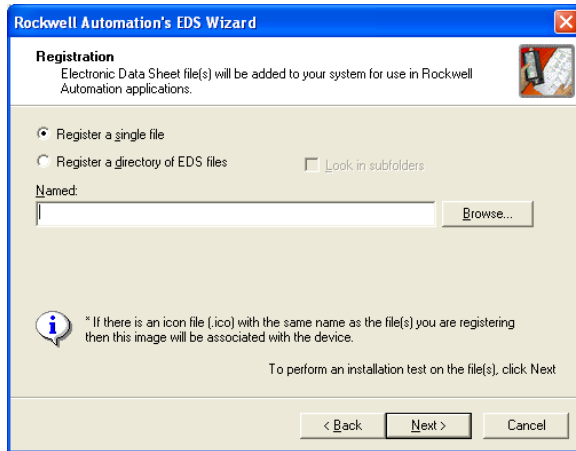

Figure 4-13: EDS Wizard – EDS Registration Screen

In the Registration screen, click the **Browse** button and access the folder containing the EDS file.

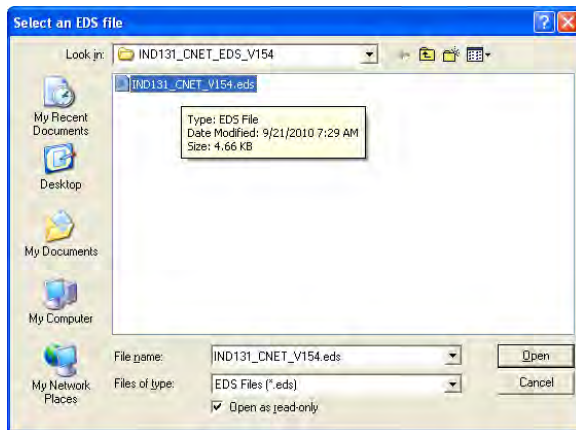

Figure 4-14: EDS Wizard – Browsing to EDS File Location

Once the correct EDS file is displayed, select it and click **Open**. The Registration screen will now show the file's path.

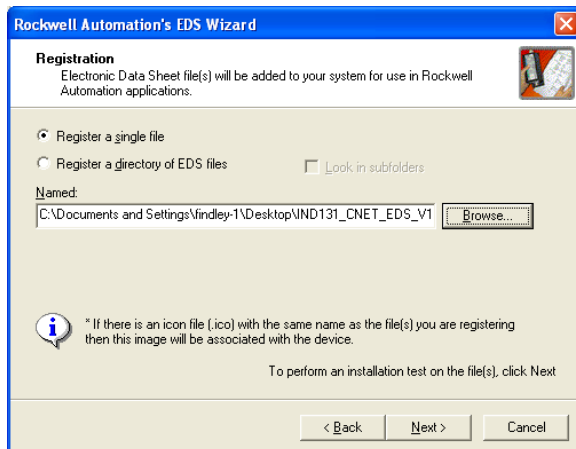

Figure 4-15: EDS Wizard – Registration, EDS File Selected

Click Next four times to step through the screens shown in Figure 4-16.

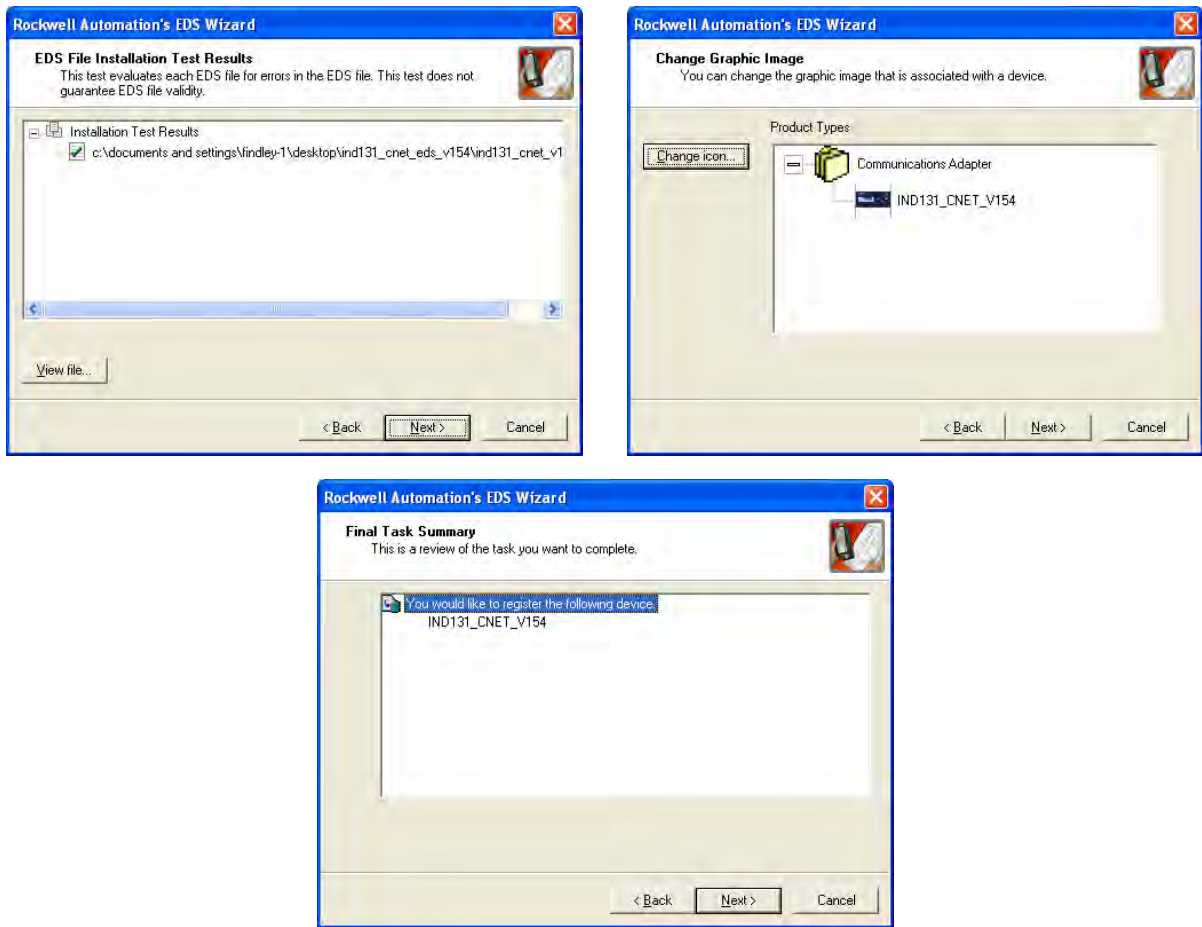

Figure 4-16: EDS Wizard – Completing the Registration

Finally, the Wizard's completion screen will display.



Figure 4-17: EDS Wizard –Registration Confirmation

Click **Finish** to complete the process and close the Wizard.

Adding the Terminal to the Network

Now, with the IND131/IND331 registered, the unit can be added to the RSNetwork. In the RSNetwork screen (Figure 4-18), click the **Edits Enabled** checkbox at upper left.

In the Hardware tree in the pane at left in Figure 4-18, expand the **Mettler-Toledo, Inc.** branch, click on **IND131_CNET_V154** and drag it to the RSNetwork configuration pane, at right.

Click the Save icon in the toolbar at top, select **Optimize and rewrite schedule** in the confirmation dialog, and click **OK**.

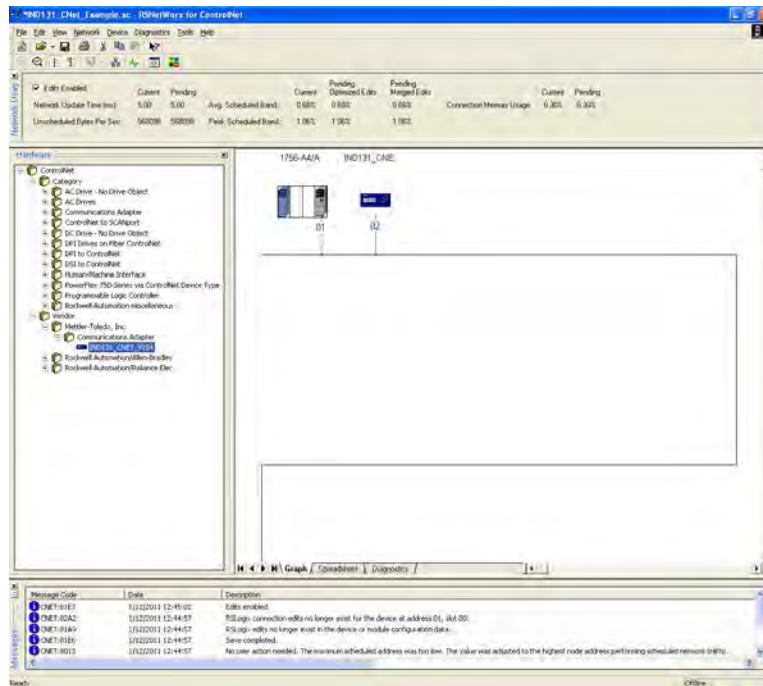

Figure 4-18: RSNetwork Screen, Edits Enabled

Click OK, minimize the window and return to RSLogix.

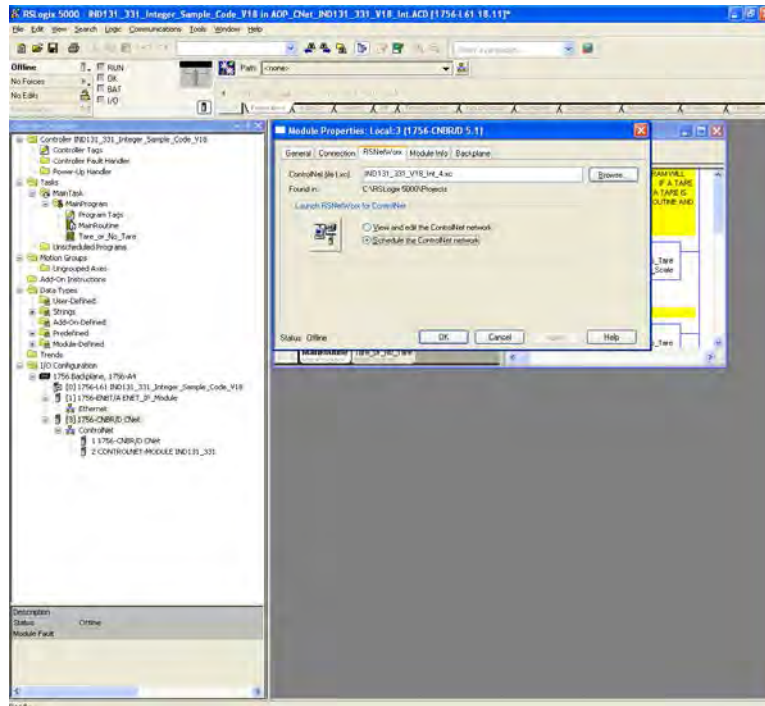

Figure 4-19: RSLogix Screen, Module Properties

In the Module Properties window, click OK.

Select the appropriate EtherNet/IP card

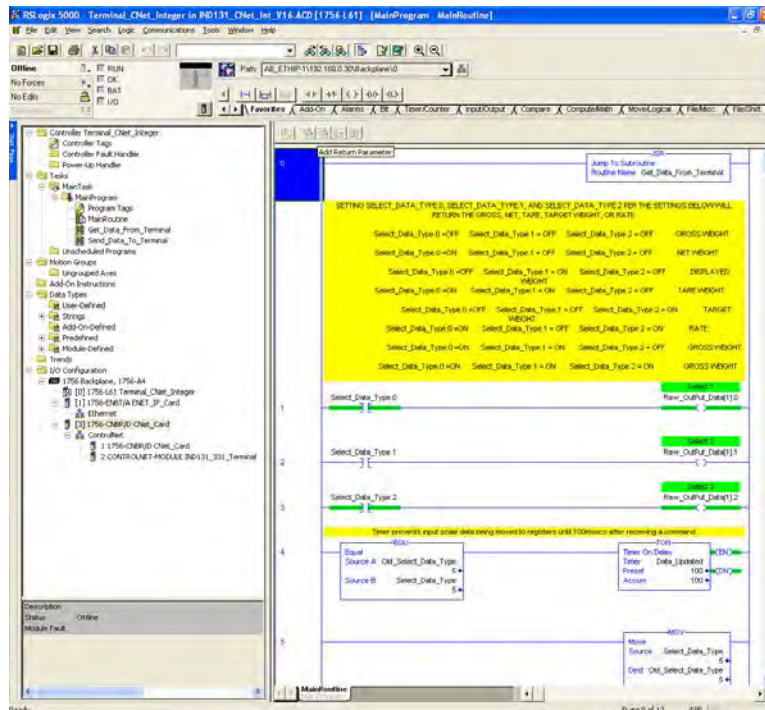

Figure 4-20: RSLogix Screen, EtherNet/IP Card Selected

Finally, download the program.

Weight Reporting

Per the Discrete Write Integer or Divisions – PLC >>IND131/331 table of the manual, Select 1 – 3, Bits 0 – 3 will cause the IND131/331 to display gross, net, displayed, tare, or target weight. This is broken down in Table 1-0 below.

Table 4-4: Truth Table to Change Data from Terminal

Select_Data_Type.0	Select_Data_Type.1	Select_Data_Type.2	Displayed Weight
OFF	OFF	OFF	Gross Weight
ON	OFF	OFF	Net Weight
OFF	ON	OFF	Displayed Weight
ON	ON	OFF	Tare Weight
OFF	OFF	ON	Target Weight
ON	OFF	ON	Rate
ON	ON	OFF	Gross Weight
ON	ON	ON	Gross Weight

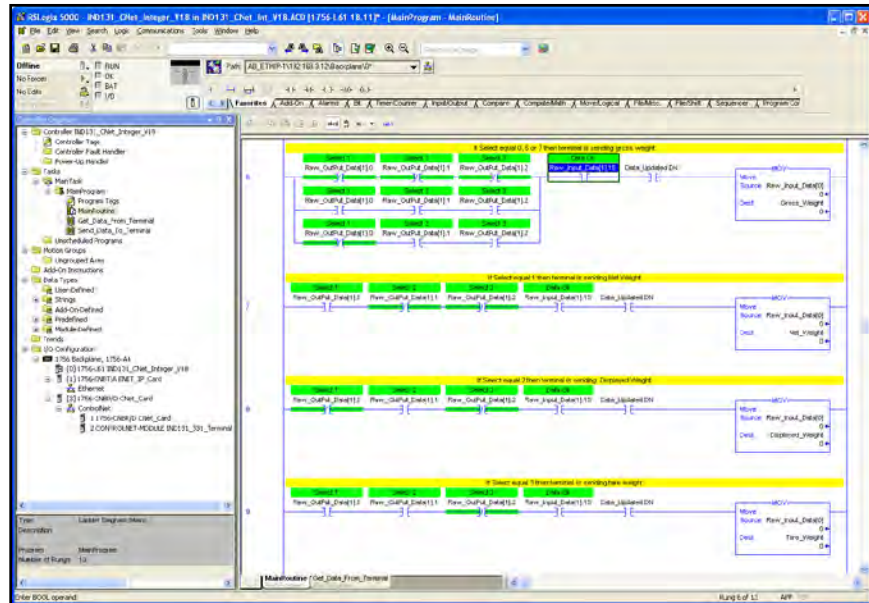

Figure 4-21: Integer/Divisions Terminal to PLC Weight Reported

This will report Gross_Weight, Net_Weight, Displayed_Weight or Tare_Weight, depending on the status of the Select, Data OK, and the Timer Done bits.

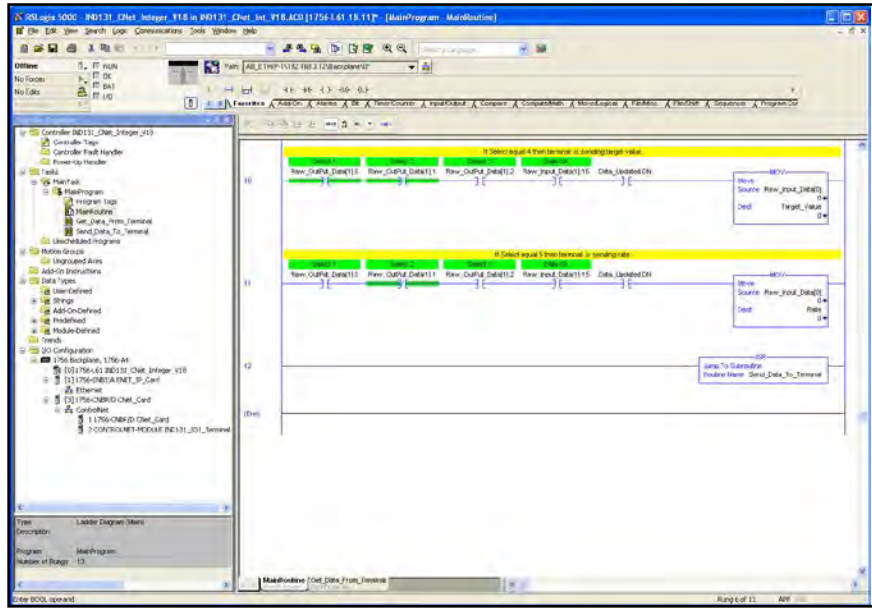

Figure 4-22: Integer/Divisions Terminal to PLC Weight Reported

For the rungs in Figure 4-22, as described by Figure 4-21, this will report the Target_Value or Rate depending on the Select, Data OK, and the Timer Done bit.

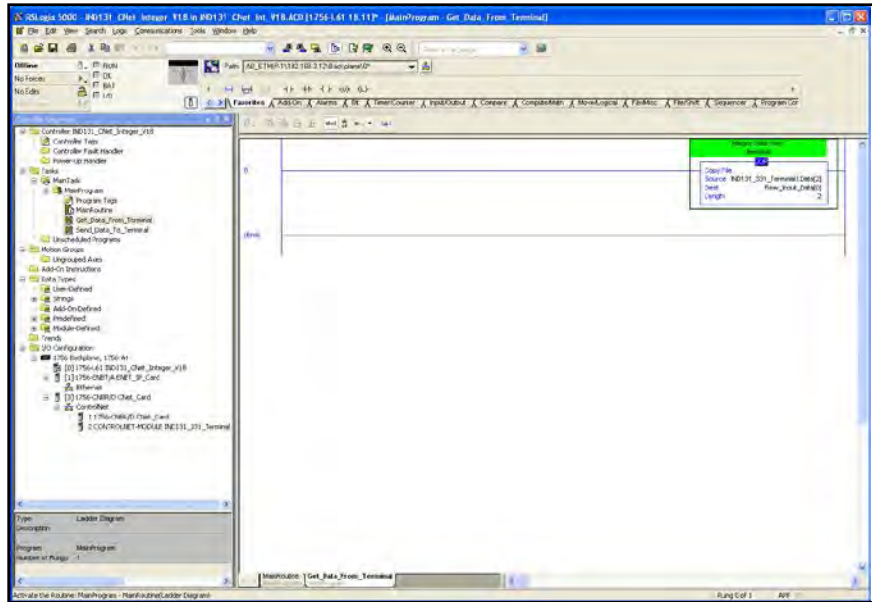

Figure 4-23: Integer/Divisions Terminal to PLC Weight Reported

This copies the last 2 words of IND131_331_Terminal starting at word 2 that will include the weight and the scale status information.

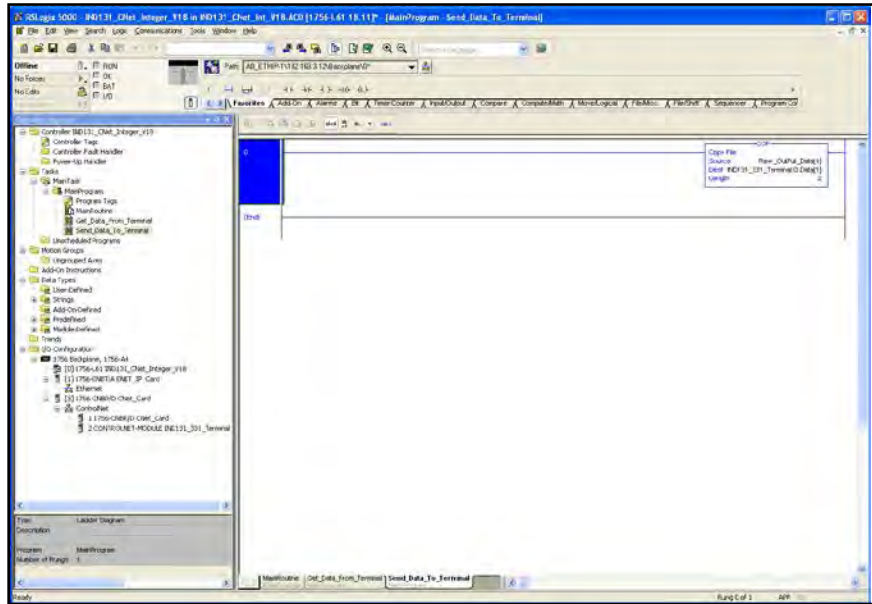

Figure 4-24: Integer/Divisions Terminal to PLC Weight Reported

This will output the status bits to have the IND131/331 report Gross_Weight, Net_Weight, Displayed_Weight, Tare_Weight, Target, or Rate back to the PLC.

Floating Point

Table 4-5 shows the relationship between the IND131/IND331 data format and the RSLogix 5000 I/O sizing for the Floating Point data format.

Table 4-5: PLC I/O Sizes (Floating Point)

16 Bit Word	
IND131/IND331 >> PLC Input	PLC Output >> IND131/IND331
6	4

Checking Module Properties

First, check the node setting. Right-click on **CONTROLNET MODULE IND131_331_Terminal**, and select **Properties**.

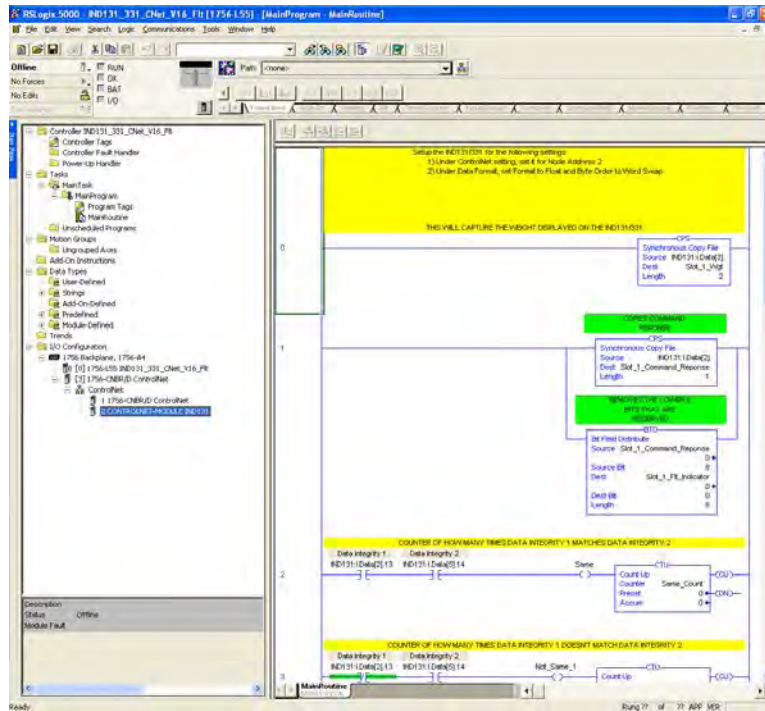

Figure 4-25: RSLogix – Checking Node Setting

A Module Properties dialog will appear, with its **General** tab displayed.

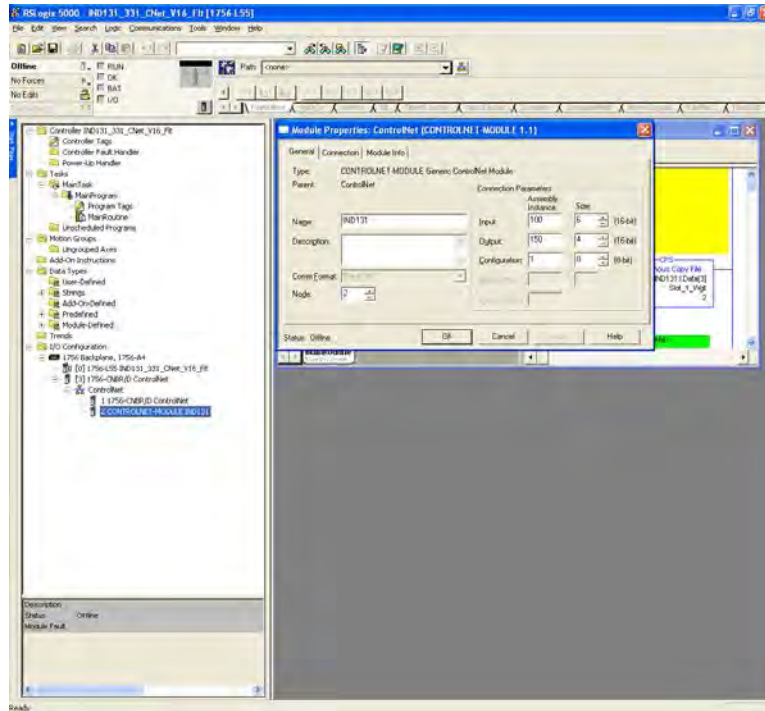

Figure 4-26: RSLogix – Module Properties, General Tab

Verify that the node shown matches the IND131/IND331 node, and click OK.

Scheduling the ControlNet Network

Now the ControlNet network must be scheduled. Right-click 1756-CNBR/D CNet_Card and select Properties.

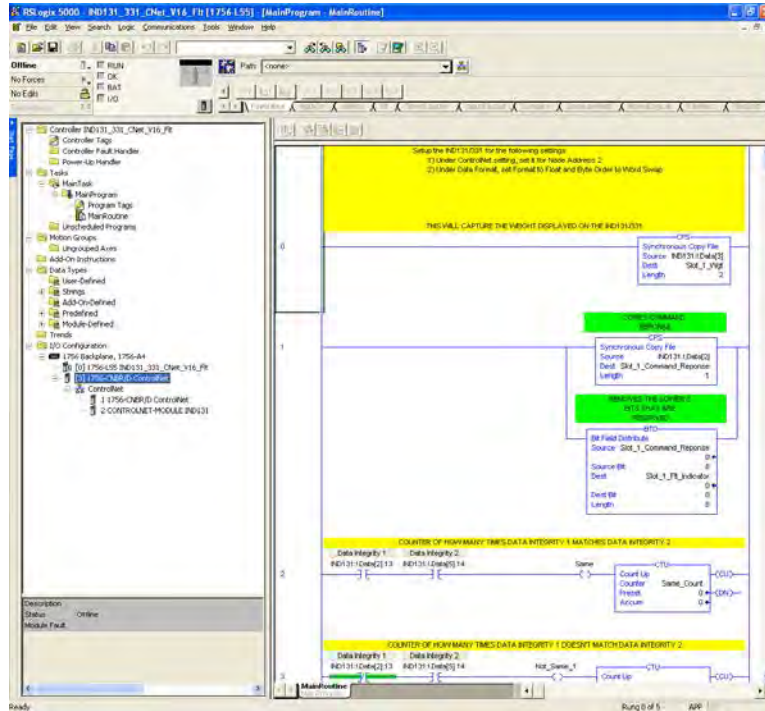

Figure 4-27: RSLogix – Scheduling ControlNet Network

In the Properties dialog, click the **RSNetworkx** tab and enter the name of the ControlNet file, if it is not already there. Click **Apply**, then click the large button at left in the dialog, to open the RSNetworkx window (Figure 4-10).

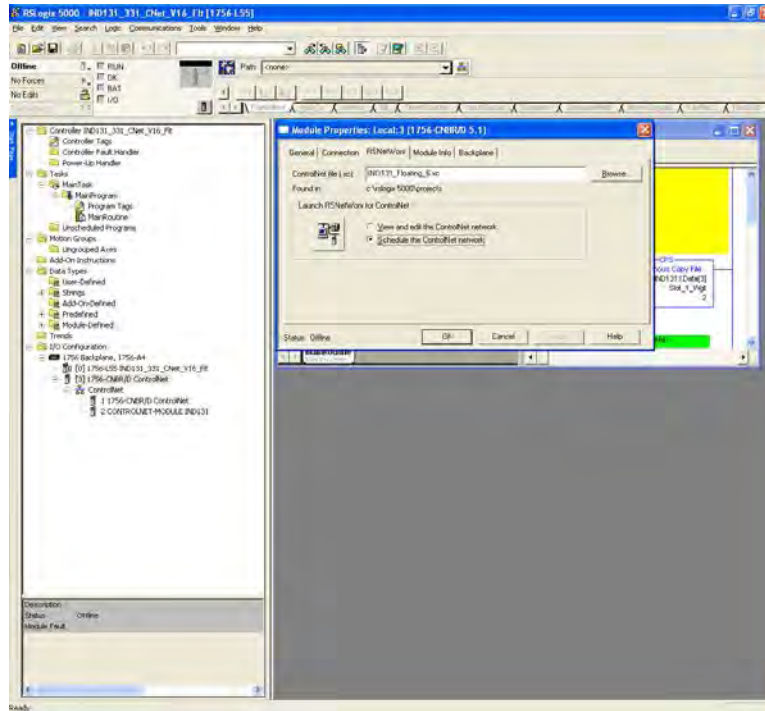

Figure 4-28: RSLogix – Module Properties, RSNetworkx Tab

Before the IND131/IND331 can be scheduled, the EDS file for the terminal must be registered. To do this in RSNetworkx, select **Tools | EDS Wizard** from the menu bar.

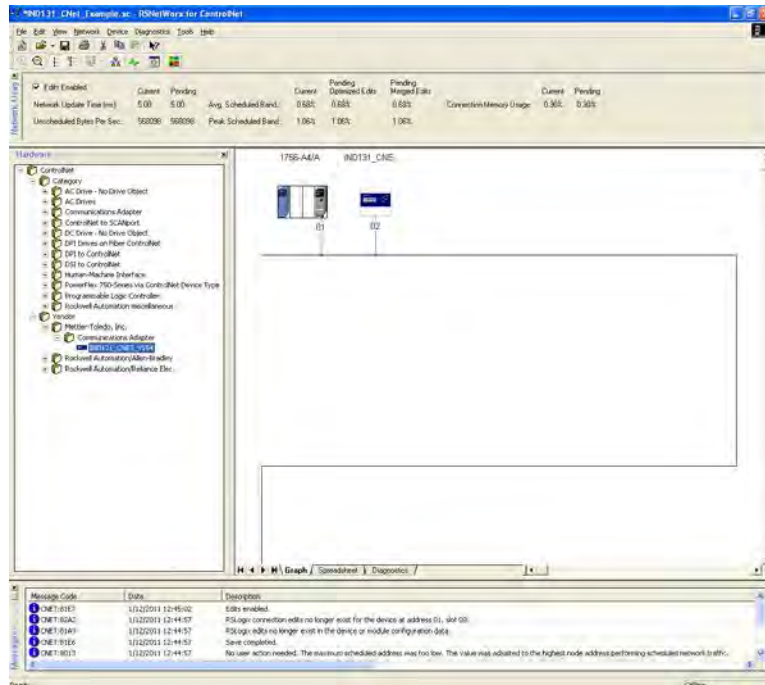

Figure 4-29: RSNetworkx Window

The EDS Wizard window will open.



Figure 4-30: EDS Wizard – Welcome Screen

Click **Next**.

The Wizard's **Options** screen shows the **Register an EDS file(s)** option selected by default.

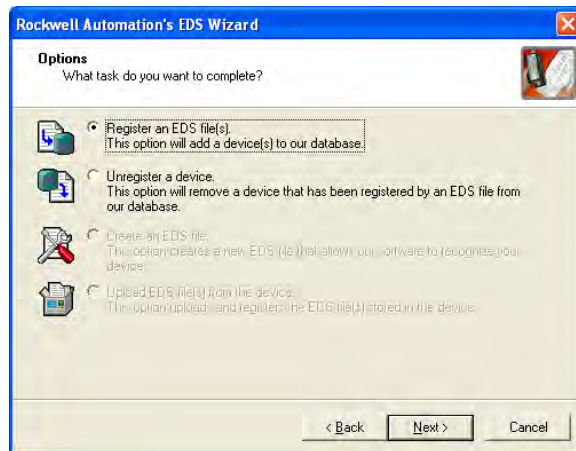

Figure 4-31: EDS Wizard Welcome Screen

Click **Next**.

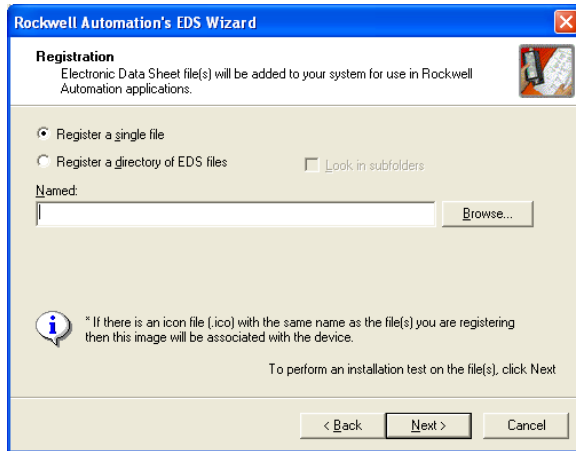

Figure 4-32: EDS Wizard – EDS Registration Screen

In the Registration screen, click the **Browse** button and access the folder containing the EDS file.

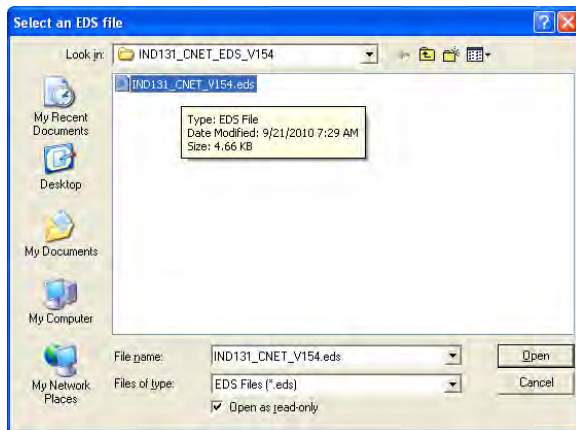

Figure 4-33: EDS Wizard – Browsing to EDS File Location

Once the correct EDS file is displayed, select it and click **Open**. The Registration screen will now show the file's path.

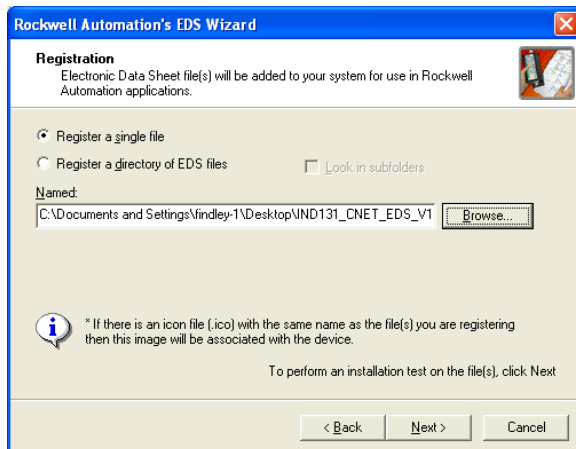

Figure 4-34: EDS Wizard – Registration, EDS File Selected

Click **Next** four times to step through the screens shown in Figure 4-16.

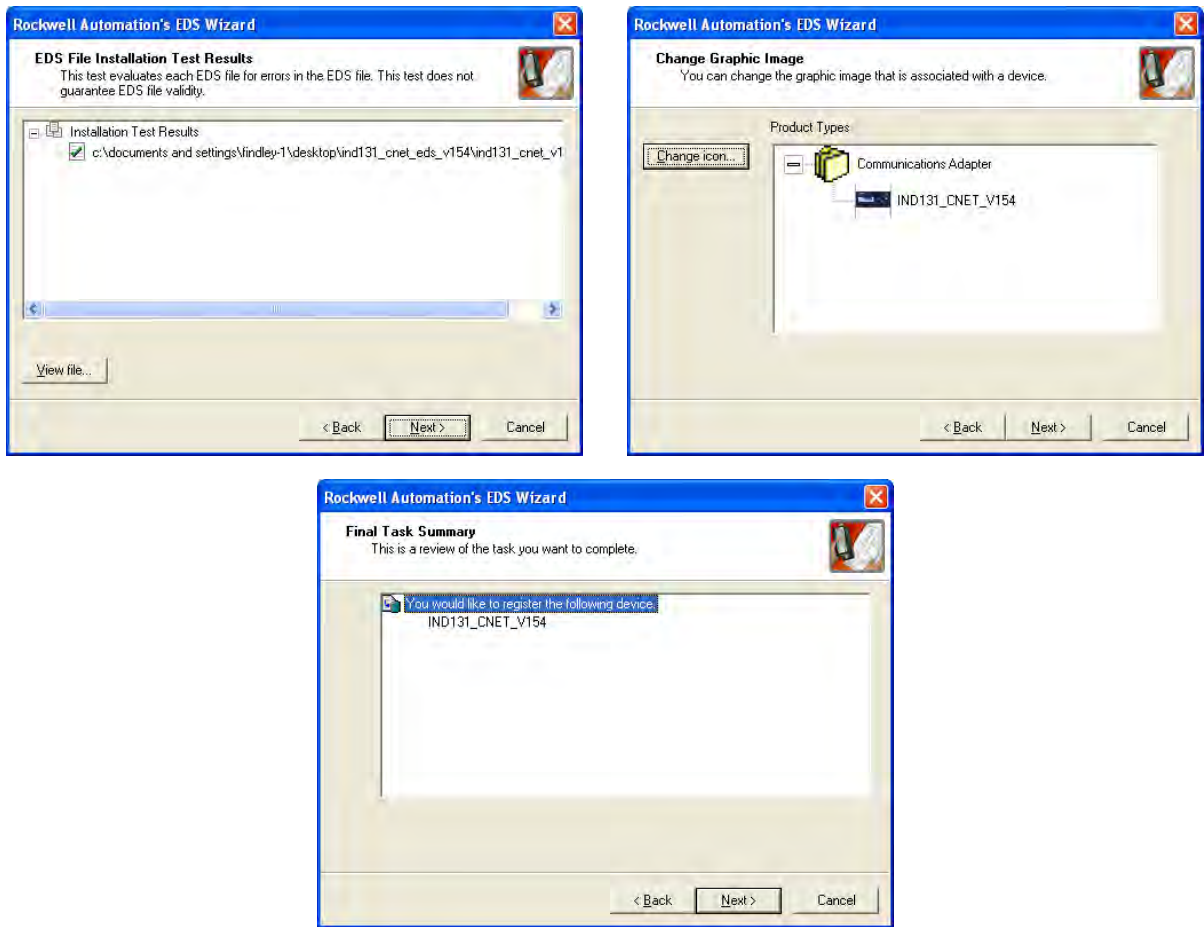

Figure 4-35: EDS Wizard – Completing the Registration

Finally, the Wizard's completion screen will display.



Figure 4-36: EDS Wizard –Registration Confirmation

Click **Finish** to complete the process and close the Wizard.

Adding the Terminal to the Network

Now, with the IND131/IND331 registered, the unit can be added to the RSNetworkx. In the RSNetworkx screen (Figure 4-18), click the **Edits Enabled** checkbox at upper left.

In the Hardware tree in the pane at left in Figure 4-18, expand the **Mettler-Toledo, Inc.** branch, click on **IND131_CNET_V154** and drag it to the RSNetworkx configuration pane, at right.

Click the Save icon in the toolbar at top, select **Optimize and rewrite schedule** in the confirmation dialog, and click **OK**.

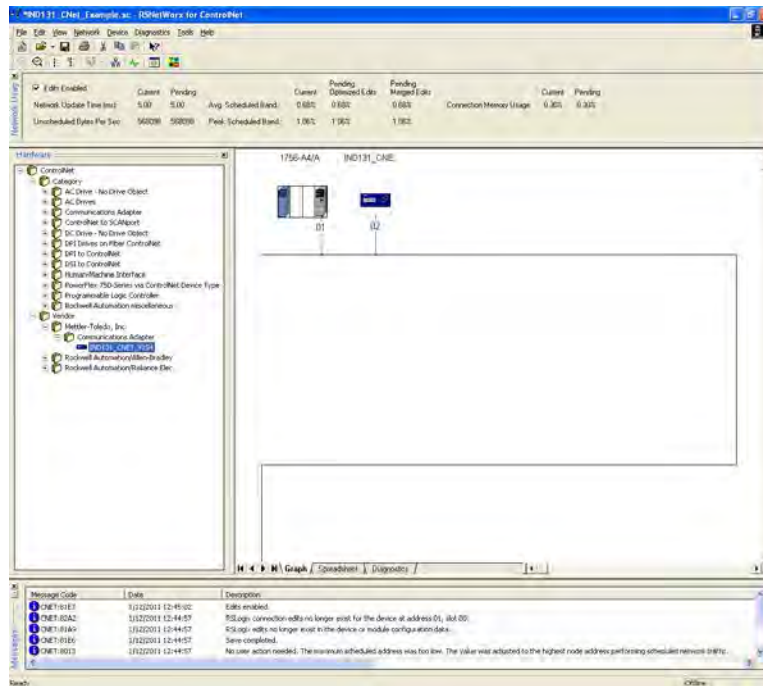

Figure 4-37: RSNetworkx Screen, Edits Enabled

Click OK, minimize the window and return to RSLogix.

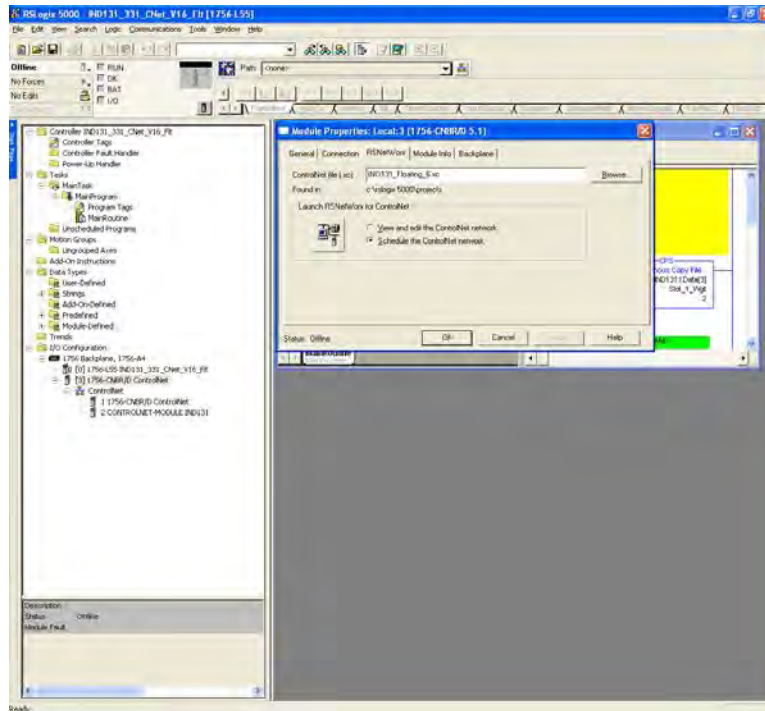

Figure 4-38: RSLogix Screen, Module Properties

In the Module Properties window, click OK.

Select the appropriate EtherNet/IP card

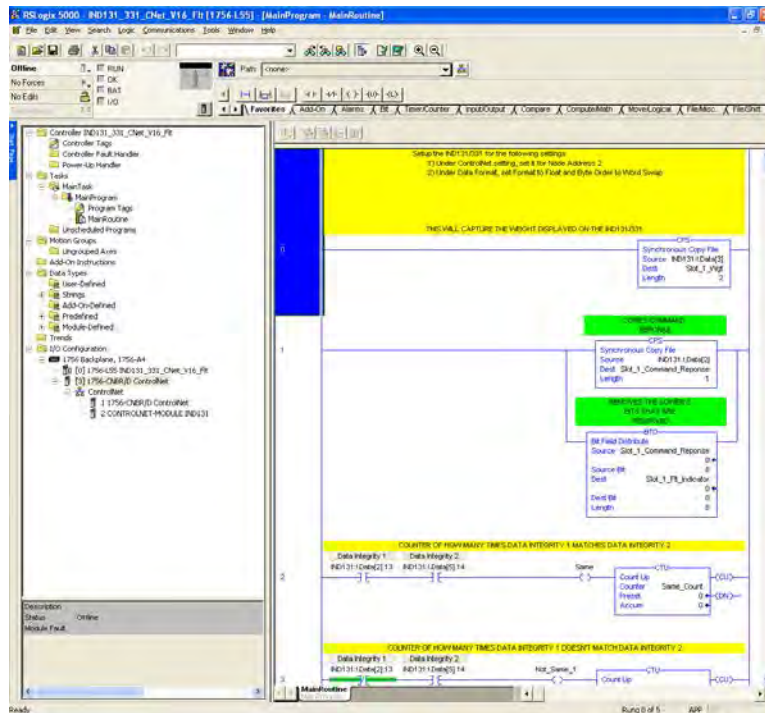

Figure 4-39: RSLogix Screen, EtherNet/IP Card Selected

Finally, download the program.

Weight Reporting

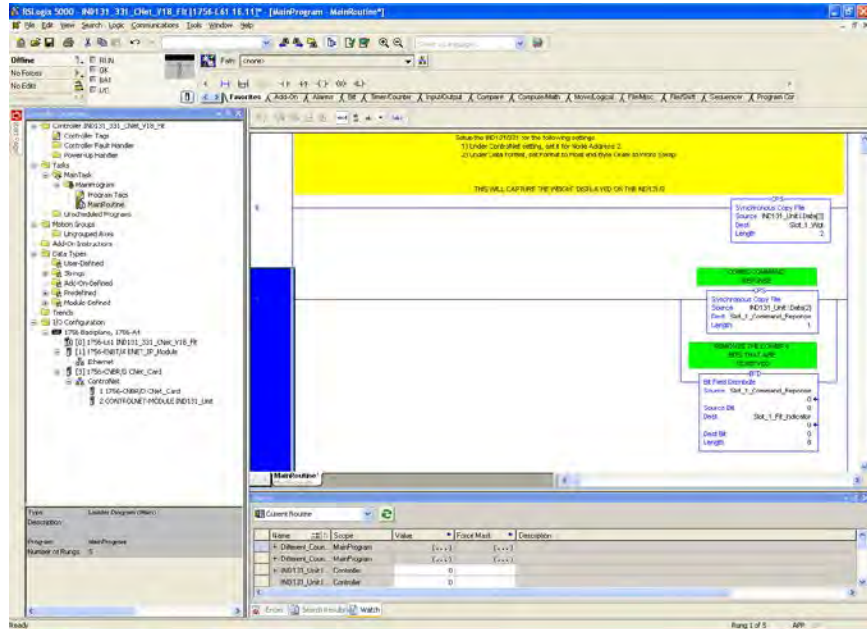

Figure 4-40: Floating Point PLC to Terminal Reported Weight

Figure 4-40 shows that Rung 0 copies the Floating Point weight and loads it into Slot_1_Wgt tag. Rung 1 captures Word 0 that includes Data Integrity 1.

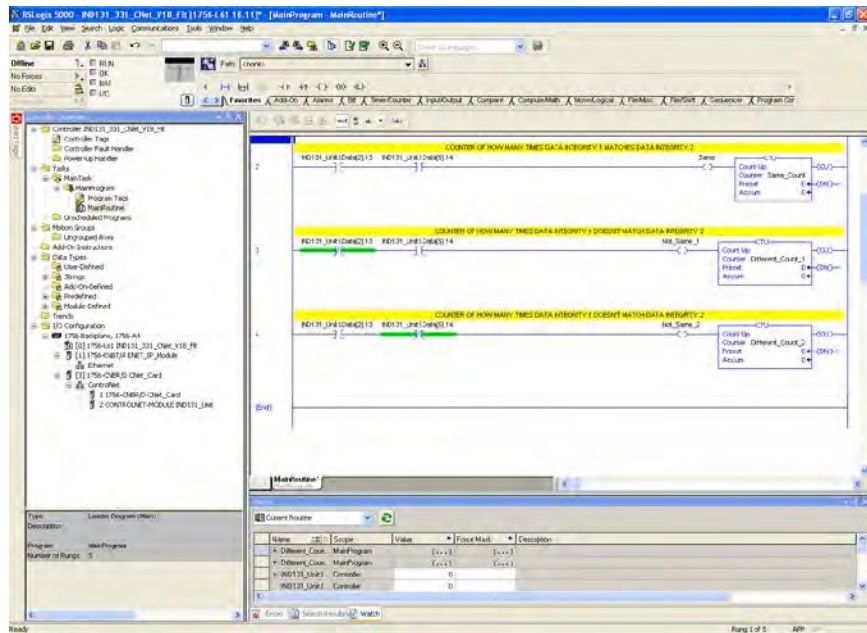

Figure 4-41: Floating Point PLC to Terminal Reported Weight

Rung 2 compares the Data Integrity Bit 1 in Word 0 with Data Integrity Bit 2 in Word 3 and if they are the same it will count up. Rung 3 and Run 4 compares the Data Integrity Bit 1 and Data Integrity Bit 2 to tell if it is different and counts accordingly.

Chapter 5

DeviceNet Option

Overview

This chapter covers

- Overview
- DeviceNet Characteristics
- Data Formats
- Hardware Setup
- Software Setup
- Troubleshooting
- Commissioning and Configuration Examples

Users should note that the DeviceNet option is used in the Mettler Toledo IND131/IND331, IND560 and IND780 terminals. There are minor differences in the polled data between the terminals. All terminals share the same EDS file and Icon file for use in a DeviceNet network configuration tool.

DeviceNet is an RS-485 based network utilizing CAN chip technology. This network was created for bit and byte-level devices. The network can be configured to run up to 500Kbits per second depending on cabling and distances. Messages are limited to 8 un-fragmented bytes. Any larger message must be broken up and sent in multiples. The IND131/IND331 implementation of DeviceNet does not support fragmented messages - all messages are 8 bytes or shorter. The

network is capable of 64 nodes including the master, commonly called the scanner.

DeviceNet Characteristics

- DeviceNet specific cable (twisted pair)
- Access to intelligence present in low-level devices – Master/Slave and Peer-to-Peer capabilities
- Trunkline-dropline configuration
- Support for up to 64 nodes
- Node removal without severing the network
- Simultaneous support for both network-powered (sensors) and self-powered (actuators) devices
- Use of sealed or open style connectors
- Protection from wiring errors
- Selectable baud rates of 125k baud, 250k baud, and 500k baud. Maximum trunk distance 500 meters and drop length of 156 meters at 125k baud
- Adjustable power configuration to meet individual application needs
- High current capability (up to 8 amps per supply)

- Operation with off-the-shelf power supplies
- Power taps that allow the connection of several power supplies from multiple vendors that comply with DeviceNet standards
- Built-in overload protection
- Power available along the bus: both signal and power lines contained in the trunkline
- Provisions for the typical request/response-oriented network communications
- Provisions for the efficient movement of I/O data
- Fragmentation (anything in excess of 8 bytes) for moving larger bodies of information Note: Mettler Toledo Terminals do not support fragmented messaging.
- Duplicate MAC ID detection

Consult <http://www.odva.org/> to obtain additional information on DeviceNet.

Figure 5-1 shows a view of the DeviceNet Option Board, with its connector at lower left.

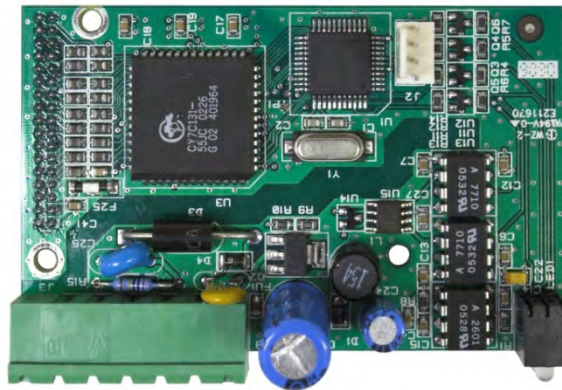

Figure 5-1: DeviceNet Option Board

Communications

The IND131/IND331 utilizes polled messages. This type of message may be referred to as scheduled or cyclic messages. It does not support explicit or unscheduled messaging.

Node Address

The IND131/IND331 can be assigned any valid DeviceNet node address. Typically 0 is reserved for scanner cards and address 63 is reserved for new devices "out of the box".

Network Power and Current

Table 5-1: Network Power Consumption

Voltage	Current
11 V	50 mA
25 V	30 mA

Table 5-2: Network Inrush Current

Voltage	Current	Duration
24 V	0.7 A	6 ms

Data Formats

While being polled, the IND131/IND331 DeviceNet option supports floating point, integer, and division formats. Refer to Appendix A, **Data Definition**, for details on these formats.

Hardware Setup

Wiring

The IND131/IND331 DeviceNet 5-position terminal block is shown in Figure 5-2 and the signal details are listed in Table 5-3. Consult <http://www.odva.org/> for additional DeviceNet wiring information.



Figure 5-2: DeviceNet Connector Pin Numbering

Table 5-3: DeviceNet Wiring Scheme

Pin Number	Description	Wire Color
1	V –	Black
2	CAN L	Green
3	Drain	

Pin Number	Description	Wire Color
4	CAN H	White
5	V +	Red

Software Setup

The IND131/IND331 terminal automatically detects the presence of a DeviceNet Kit option board if one is installed. When the option is detected, the IND131/IND331 terminal adds the DeviceNet parameters in a program block under Communications > PLC. Figure 5-3 graphs the DeviceNet and PLC Data Format program blocks.

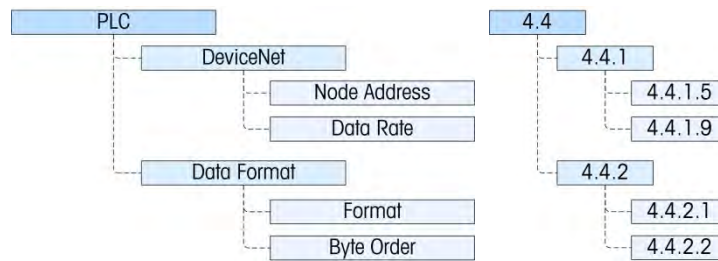

Figure 5-3: The DeviceNet Program Block and Data Format Setup Block

In this section, figures given in brackets (e.g. [0]) correspond to the parameter options available when F-codes are displayed by the terminal.

DeviceNet and Data Format Setup Blocks

DeviceNet Setup – F4.4.1

The menus in this block are used to set up the DeviceNet option.

Node Address – F4.4.1.5

Each IND131/IND331 Terminal connected to the network represents one physical node. This address is determined by the system designer, then configured in the terminal by entering the Node Address (0 to 63). The default address is 63.

Data Rate – F4.4.1.9

In the Data Rate menu, select the desired data rate from these options:

125 Kb [0] (the default) 250 Kb [1] 500 Kb [2]

Data Format Setup – F4.4.2

The Data Format branch provides access to the Format and Byte Order parameters.

Format – F4.4.2.1

From this menu, select a data format for the DeviceNet network. The choices are **Division [0]**, **Floating Point [1]** and **Integer [2]** (the default).

Division – displays scale weight in display divisions. The PLC multiplies the display divisions by the increment size to calculate the weight in display units.

Floating Point – displays weight in floating point data format

Integer – displays scale weight as a signed 16 bit integer (± 32767)

Byte Order – F4.4.2.2

This parameter selects the order in which the data bytes and words will be presented in the PLC data format. The choices are **Byte Swap [0]**, **Standard [1]**, **Word Swap [2]** (the default) and **Double Word Swap [3]**.

- **Byte Swap** – Makes the floating point format compatible with S7 PROFIBUS.
- **Standard** – Makes the data format compatible with PLC5.
- **Word Swap** – Takes the IEE 754 single-precision floating point format and swaps the two words in the 32-bit double word. This format is compatible with RSLogix 5000 processors.
- **Double Word Swap** – Makes the data format compatible with the Modicon Quantum PLC for Modbus TCP networks.

Refer to Appendix A, **Data Definition**, for additional information on byte order and data format.

Troubleshooting

All DeviceNet nodes have two status LED's. These LED's are labeled in Figure 5-4 and indicate module and network status. A description of the operation of these LEDs is given in Table 5-4 and Table 5-5 below.



Figure 5-4: DeviceNet Option Board LEDs

Module status LED (MS)

This LED displays the status of the IND131/IND331 Terminal DeviceNet board.

Table 5-4: Module Status LED

LED State	Meaning
Solid Green	Normal operation
Flashing Green	DeviceNet board fault
Off	No power to the DeviceNet board
Solid Red	Unrecoverable board fault
Flashing Red	Recoverable fault
Flashing Orange	Board performing self-test

Note: If the module status LED indicates anything other than solid green after powering up the unit and attaching the DeviceNet cable, the IND131/IND331 Terminal must be powered down and restarted. If the LED continues to show a condition other than solid green, replace the board.

Network status LED (NS)

This LED displays network status.

Table 5-5: Network Status LED

LED State	Meaning
Solid Green	Node is communicating to scanner
Flashing Green	Device is connected to the network but not being scanned. The most common reason for this is the device has not been added to the scan list. Consult DeviceNet configuration tool's help in order to commission the node and put it in the scan list.
Off	No DeviceNet power
Solid Red	Critical Link error This error typically indicates a cable problem
Blinking Red	Connection Timeout

Procedure

If the IND131/IND331 does not communicate with PLC, do the following:

- Check wiring and network termination.
- Confirm that the IND131/IND331 settings for address, baud rate, format and byte order match those in the PLC and that each IND131/IND331 has a unique address.

- If neither of the checks above resolves the issue, contact an authorized service location of METTLER TOLEDO.

Commissioning and Configuration Examples

The user must register the EDS, connect the device and add the IND131/IND331 Terminal to the DeviceNet master's scan list. Note that every vendor's software is different. Depending upon master and software, the user may have to cycle power on the master in order to complete the commissioning of any device added to the network. Consult the master's documentation for more information. The following example is for Rockwell software and Logix5000 processor.

Configuring the IND131/IND331 Terminal with RSNetWorx for DeviceNet

The EDS file located on the CD-ROM supplied with the IND131/IND331 Terminal contains configuration information to allow RSNetWorx for DeviceNet to set up a single polled I/O connection between a METTLER TOLEDO IND131/IND331 Terminal and DeviceNet master/scanner. Note that this order of operations isn't the only way of configuring the IND131/IND331 terminal.

Registering the EDS file

The EDS file must first be registered into RSNetWorx for DeviceNet. This is accomplished using the EDS Wizard.

To access the EDS Wizard:

1. Click **Tools** then **EDS Wizard...** to begin the registration process.



Figure 5-5: Accessing the EDS Wizard

2. The EDS Wizard Welcome screen appears.

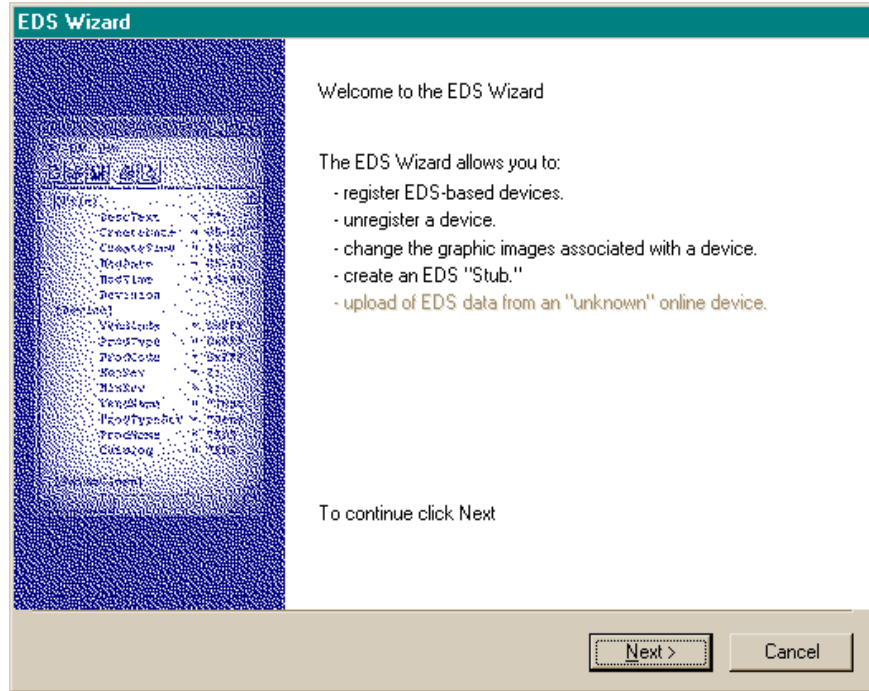

Figure 5-6: EDS Wizard Welcome

3. Click Next to begin the registration process.
4. In the Options screen, make sure the Register an EDS file(s) radio button is selected.

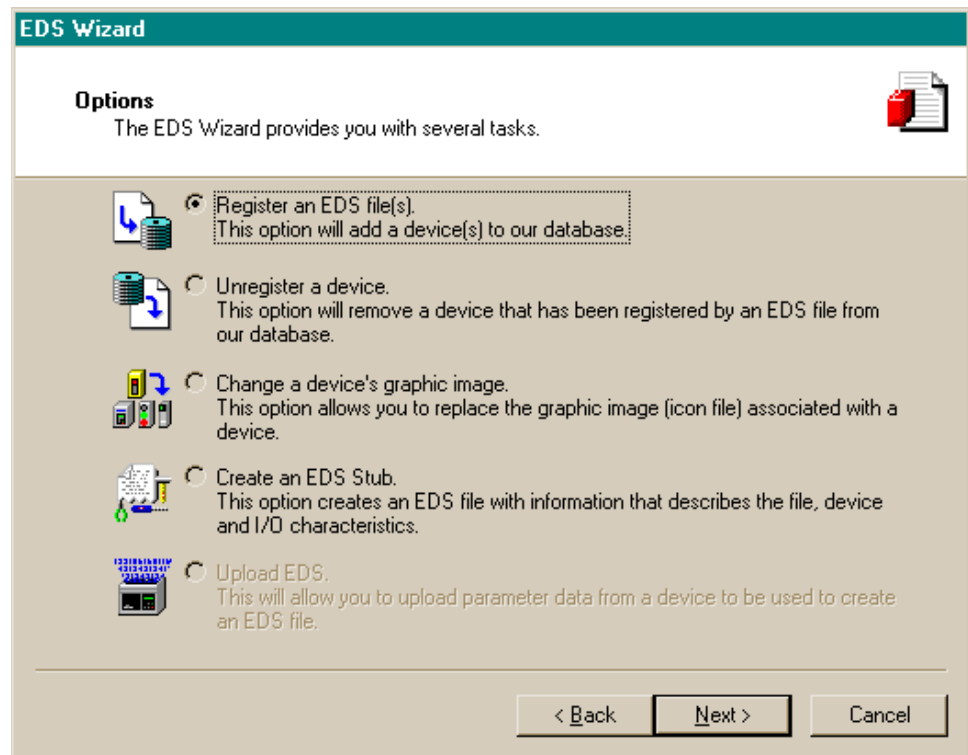

Figure 5-7: EDS Wizard Options Screen

5. Click Next, then Browse to select a file to register.
6. Browse to the appropriate location and select the file MT_IND-DNET.eds. (The EDS file is located on the CD-ROM.) Click the Open button.
 - Note that this file is shared with other METTLER TOLEDO terminals such as the IND560 and IND780.
7. Confirm that the correct file is showing in the Named: field, then click Next.

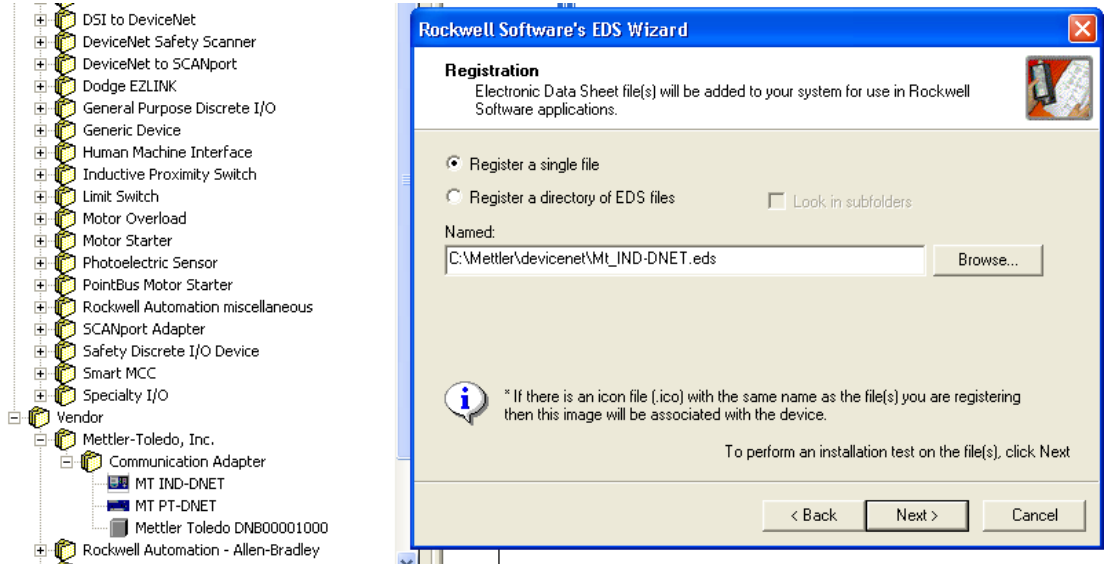

Figure 5-8: File Selected, Ready to Register

- Acknowledge the error applet. This error is generated due to the EDS file being generic for other MT devices. The IO sizes will be configured later in the process.

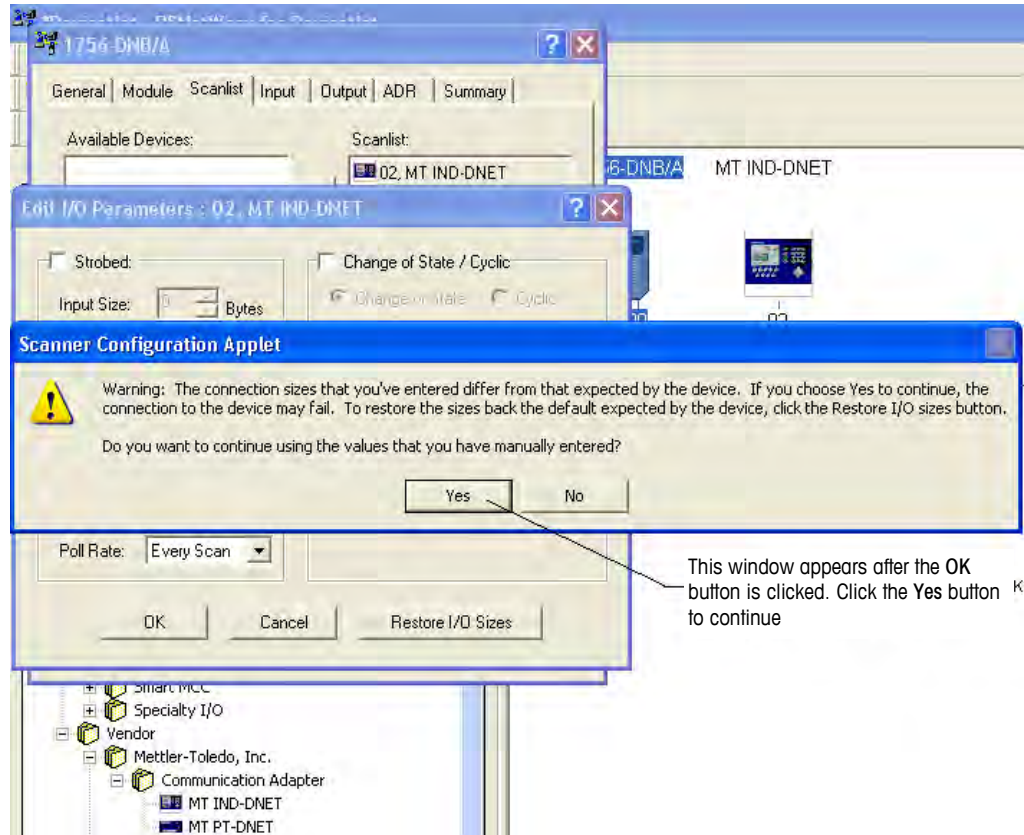

Figure 5-9: File Validity Confirmed

9. Ensure that the MT_IND-DNET.ico icon is selected.

Note: RSNetWorx for DeviceNet will not be able to find the icon unless it is in the same directory as the EDS file.



Figure 5-10: EDS Wizard Graphic Image (Icon) Selection

10. The Final Task Summary screen (Figure 5-11) will appear. Click Next.

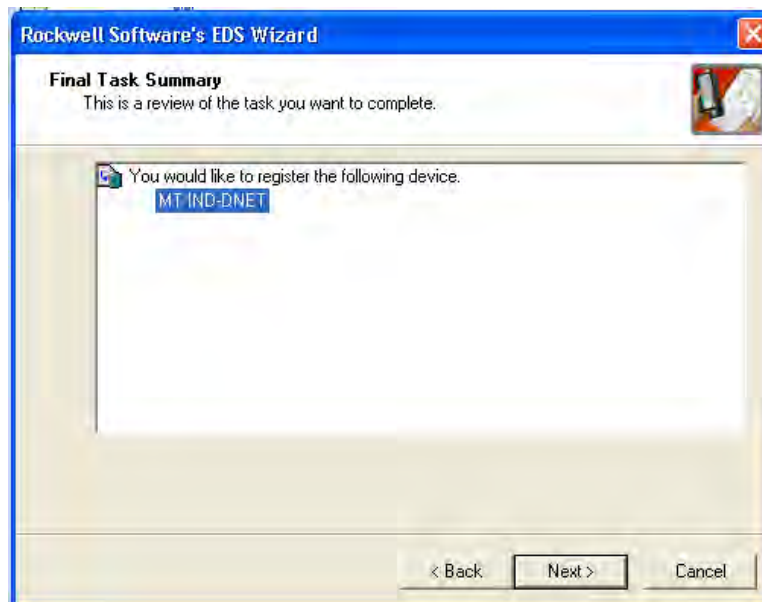

Figure 5-11: Final Task Summary Screen

Setting up an I/O Connection

After the EDS file has been registered, RSNetWorx is used to set up a polled connection between the METTLER TOLEDO IND Terminal and the DeviceNet master/scanner.

To set up the connection:

Note: You must add the DeviceNet scanner card and choose the proper revision before going online.

1. Select **Network** then **Online** to browse the DeviceNet network.

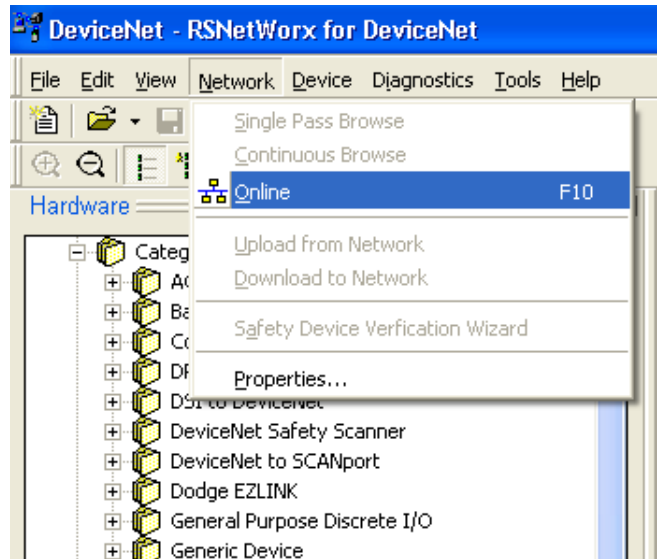

Figure 5-12: RSNetWorx Online Browse

2. Select the appropriate network path. In this case (Figure 5-13), 1756-DNB/A DeviceNet Scanner is selected.

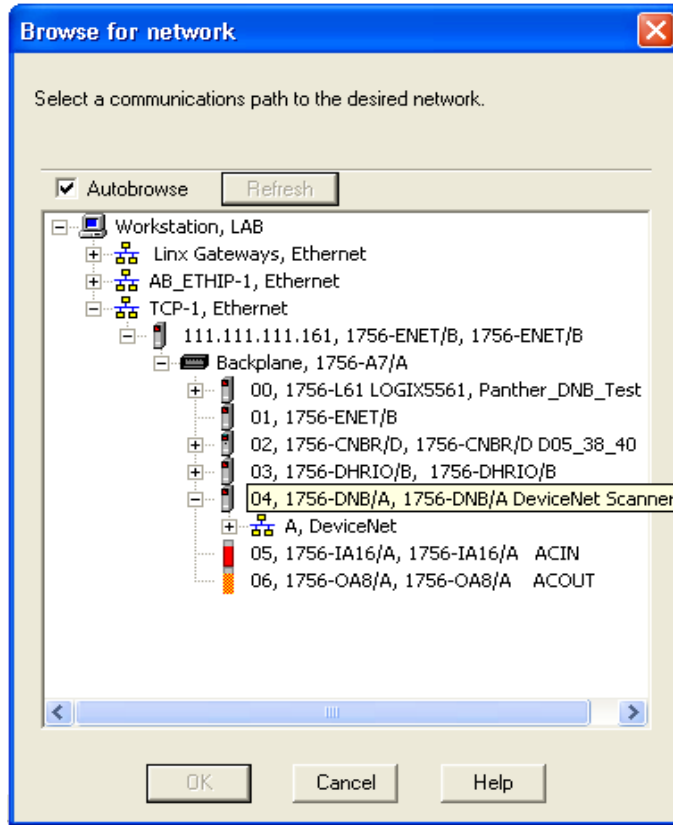

Figure 5-13: Browse for network

3. Click OK to continue. A dialog box like the one shown in Figure 5-14 will appear. Note that you may be asked to upload or download, depending on the version of software used.

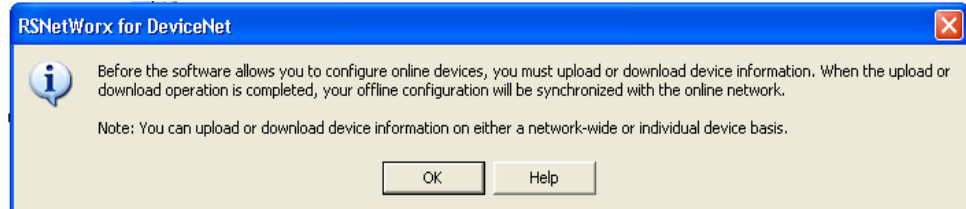

Figure 5-14: Confirmation Dialog Box

4. Click OK in the dialog box. A **Browsing network...** box will display with a progress meter indicating that the process is underway.

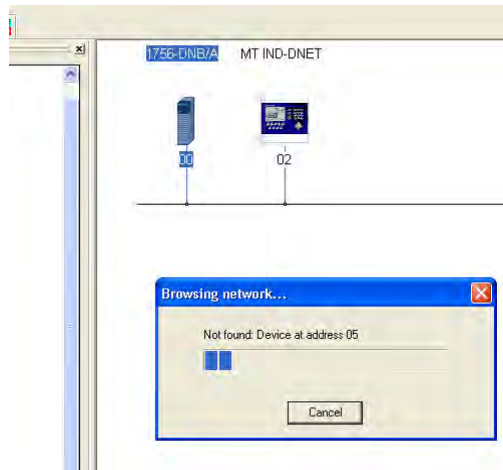

Figure 5-15: Browsing Network Underway

5. Once the scanner has browsed the entire network, add IND Terminal to the 1756-DNB/A's scanlist by right-clicking on the scanner icon in the Graph window (note the tab at the bottom of Figure 5-16), and choosing **Properties...**

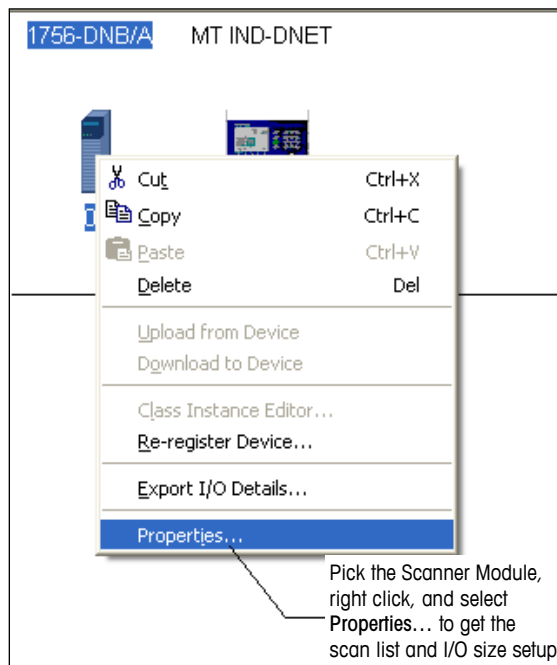

Figure 5-16: Accessing Scanner Properties

- The scanner's properties dialog box will appear, as in Figure 5-17.

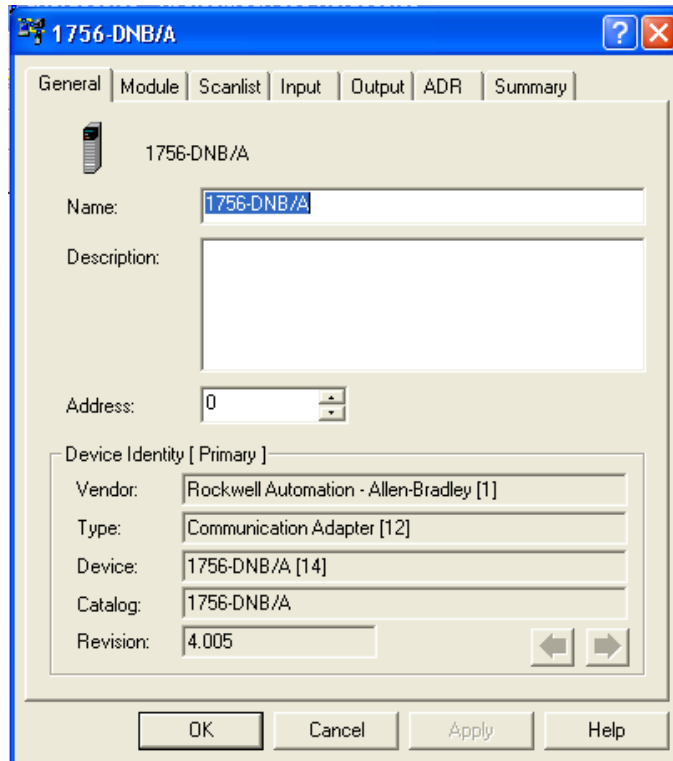

Figure 5-17: Scanner Properties Dialog: Initial View

- Click the Scanlist tab in the properties dialog box. The view shown in Figure 5-18 will appear.

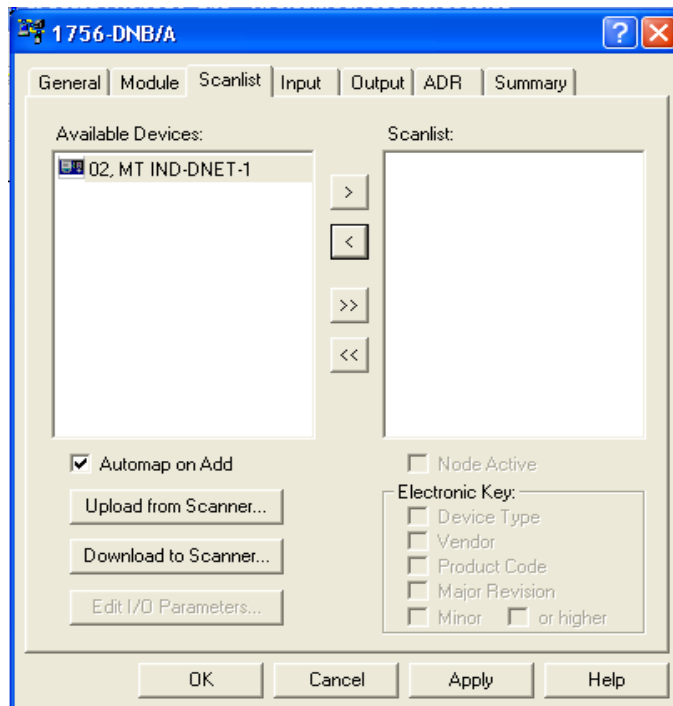

Figure 5-18: Scanner Properties Dialog: Scanlist Tab Showing

8. Highlight the IND Terminal (MT IND-DNET) and left-click to add it to the Scanlist. Once the IND Terminal is added, it will appear in the right pane (Figure 5-19). Click OK.

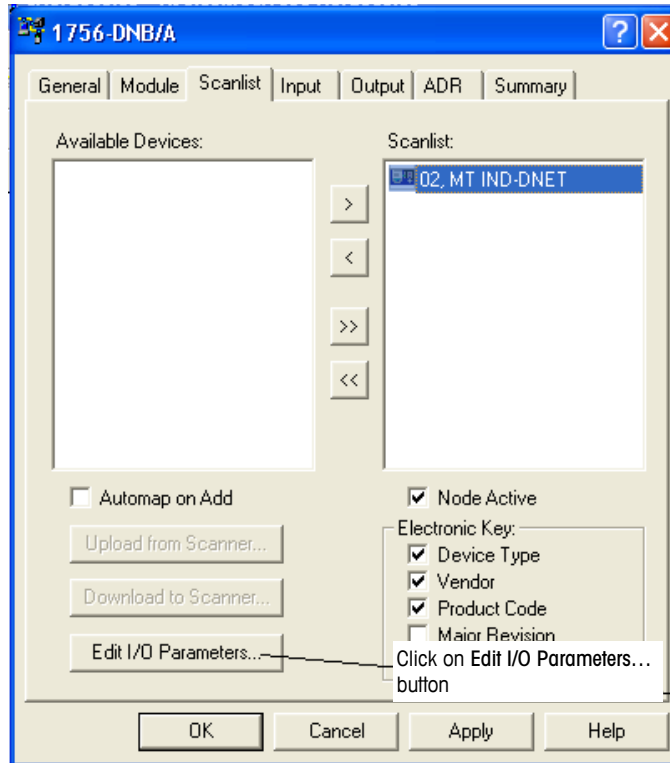

Figure 5-19: IND Terminal Added to Scanlist

- The next step is to edit the I/O parameters of the IND terminal. The I/O size depends on the data type. Integer or Divisions require 4 bytes in and 4 bytes out. Floating point requires 8 bytes in and 8 bytes out.

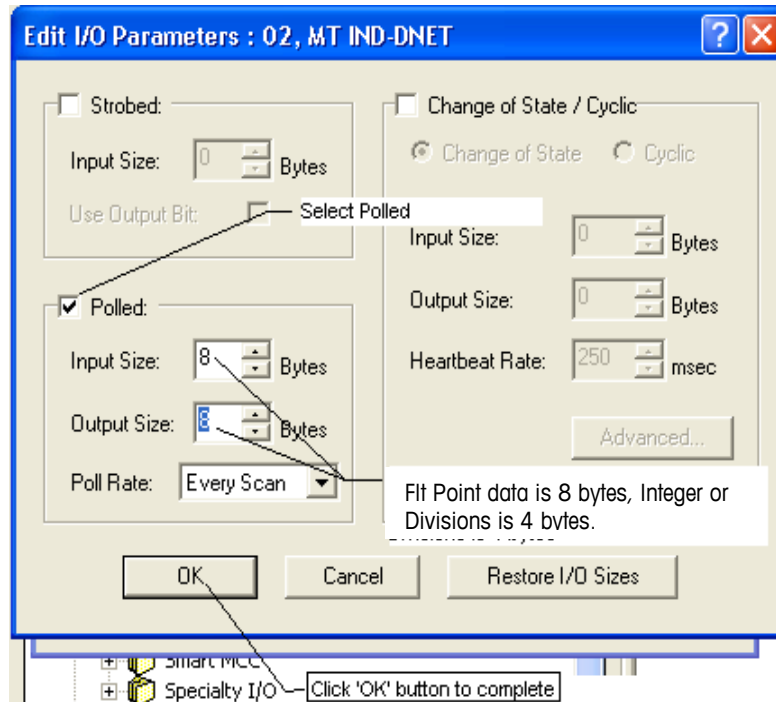

Figure 5-20: Editing I/O Parameters

- Download the configuration to the scanner card, in order to commission the network. In the prompt that appears (Figure 5-21), click Yes to continue. Note that some scanner cards may require power down for changes to take effect.

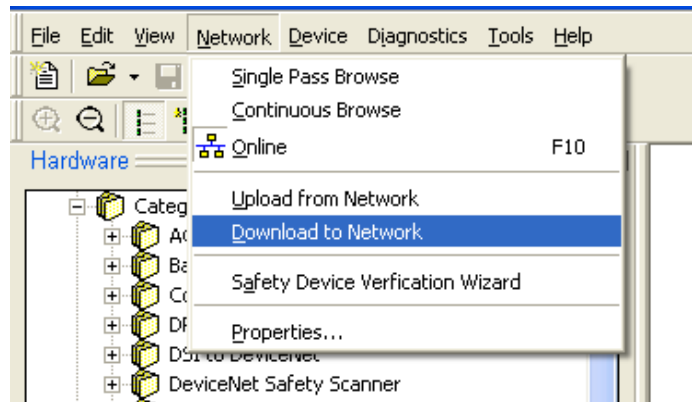

Figure 5-21: Network Download Confirmation Prompt

11. Once the IND Terminal has been added to the scanlist, access the Properties dialog to verify its I/O mapping (Figure 5-22 and Figure 5-23) within the scanner card. Note that auto or manual mapping can be used. Consult the master's documentation for advance I/O mapping options. If manual mapping is used. Be sure to start with an unused section of memory for offset.

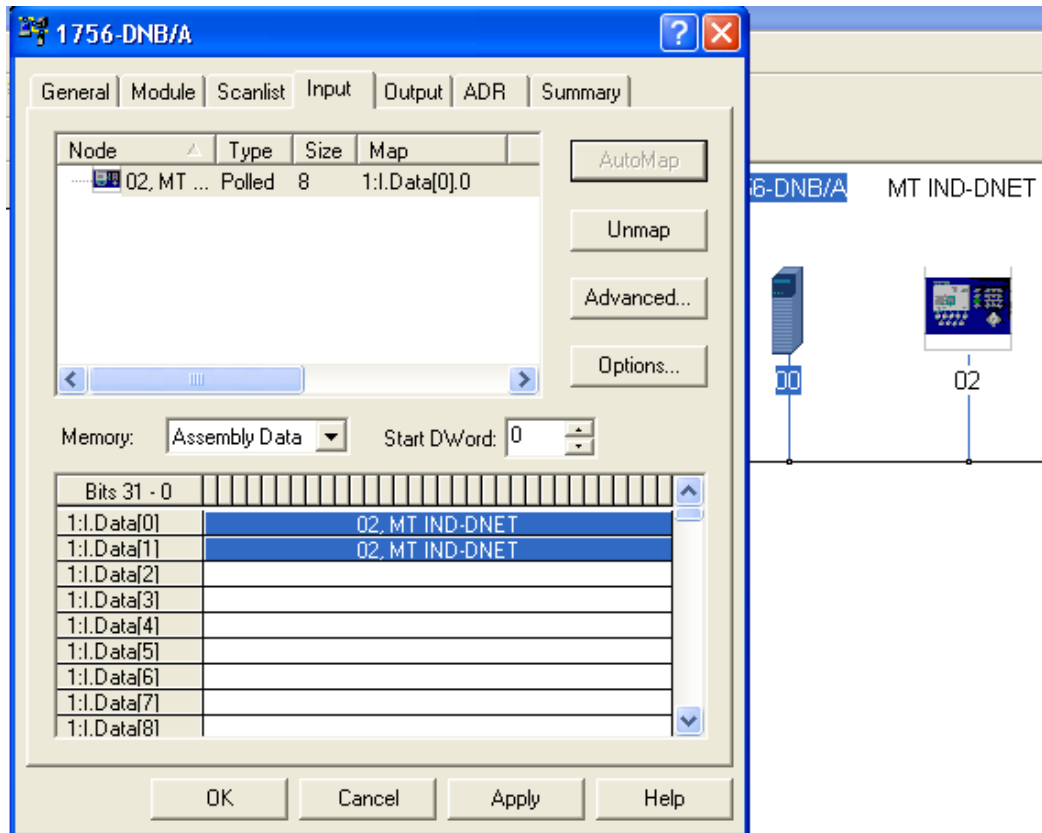

Figure 5-22: IND Terminal Mapping

12. Verify that I/O mapping is complete by choosing the summary tab. Note that the Mapped columns show Yes for the IND Terminal.

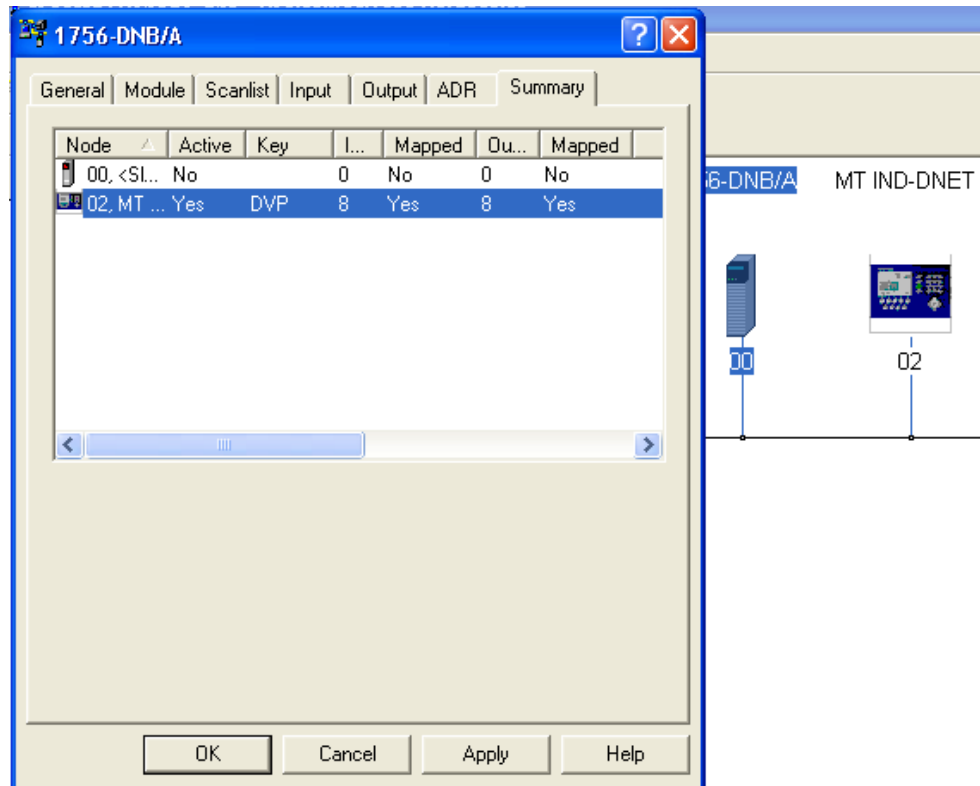

Figure 5-23: Summary Tab

PLC Programming

The IND Terminal is now ready to communicate to the master or DeviceNet scanner. You must configure the PLC or other master with DeviceNet scanner to send and receive data via polled messaging. For this example the RSLogix5000 software is used in conjunction with the ControlLogix5000 processor with DeviceNet scanner card. Note that these examples may or may not be applicable depending upon whether you have an existing program or different version of software.

Create a new project.

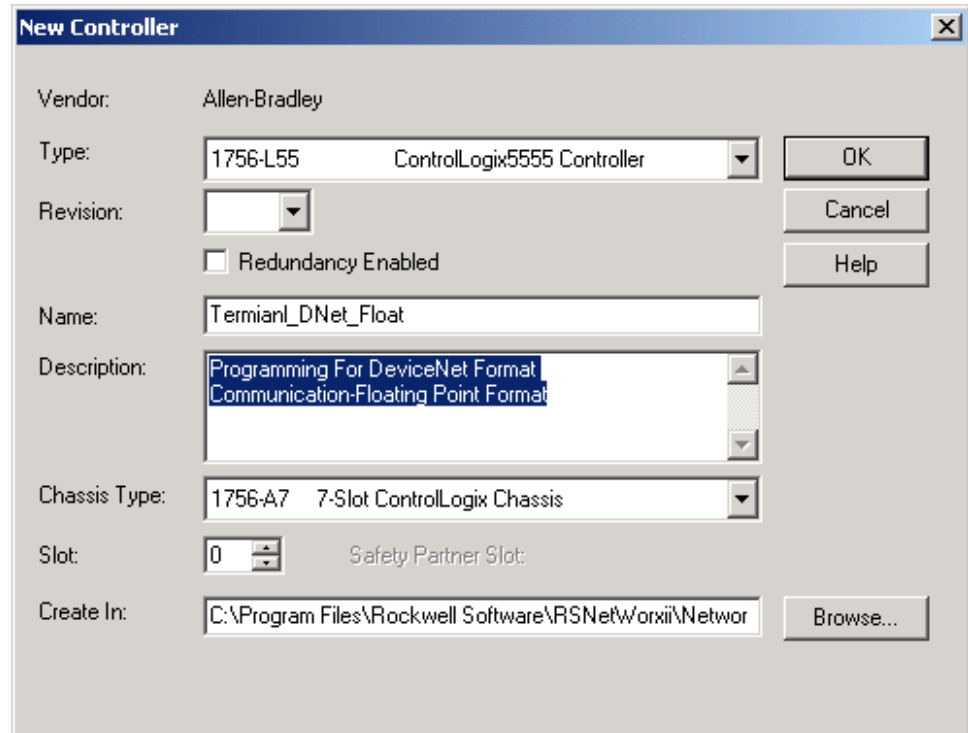

Figure 5-24: New Project Dialog

1. Add DeviceNet scanner card to existing chassis.

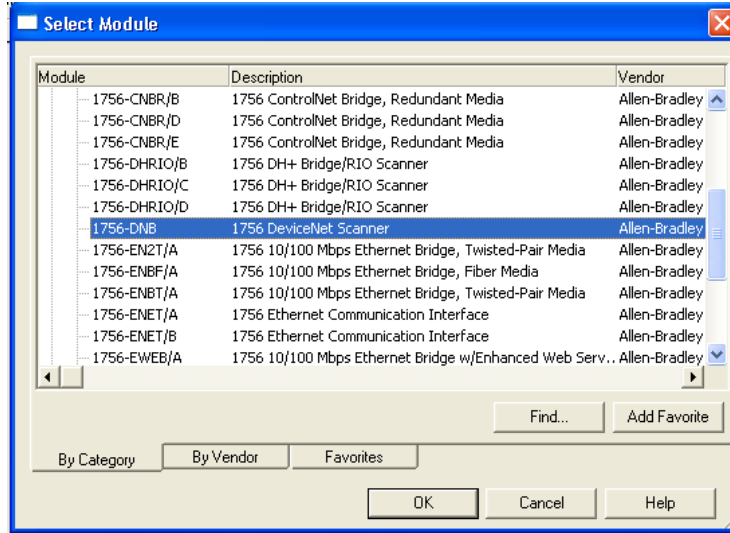

Figure 5-25: Adding DeviceNet Scanner

2. Configure scanner card. Refer to Rockwell software documentation for more information.

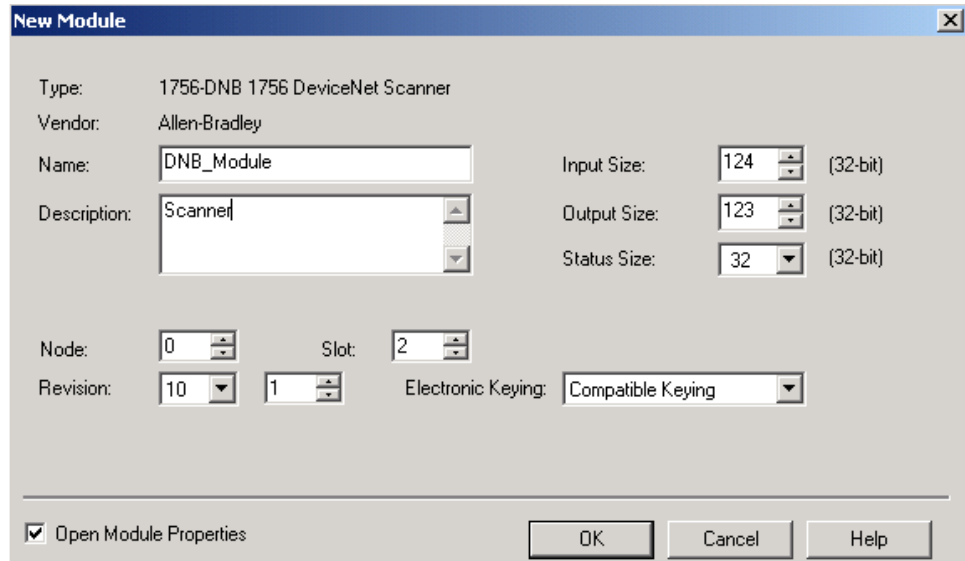

Figure 5-26: Scanner Setup

Note that examples, and the EDS and IND Terminal icon files, are located on the IND131/IND331 documentation CD that comes with every unit.

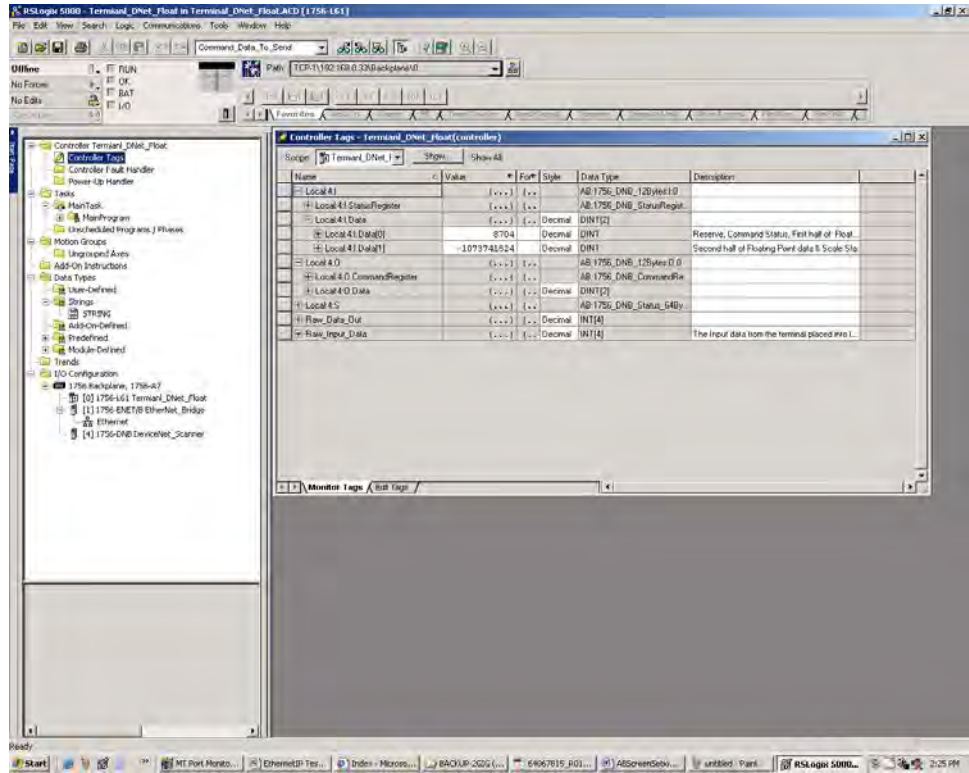

Figure 5-27: DeviceNet Floating Point Input/Output Tags

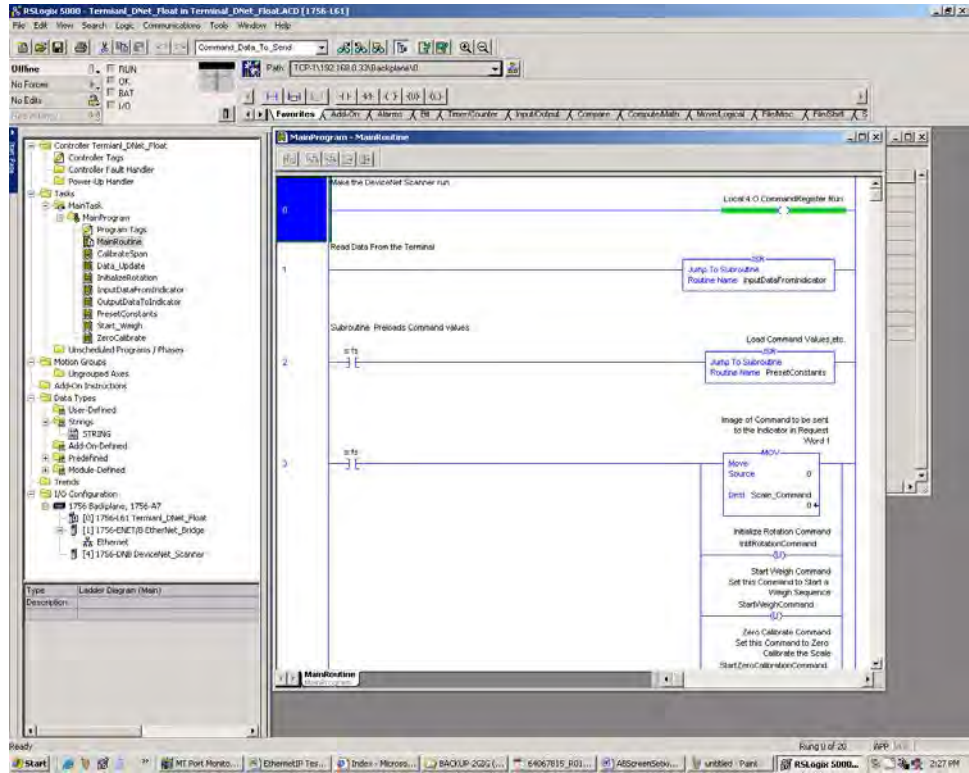

Figure 5-28: DeviceNet -Unconditional Rung

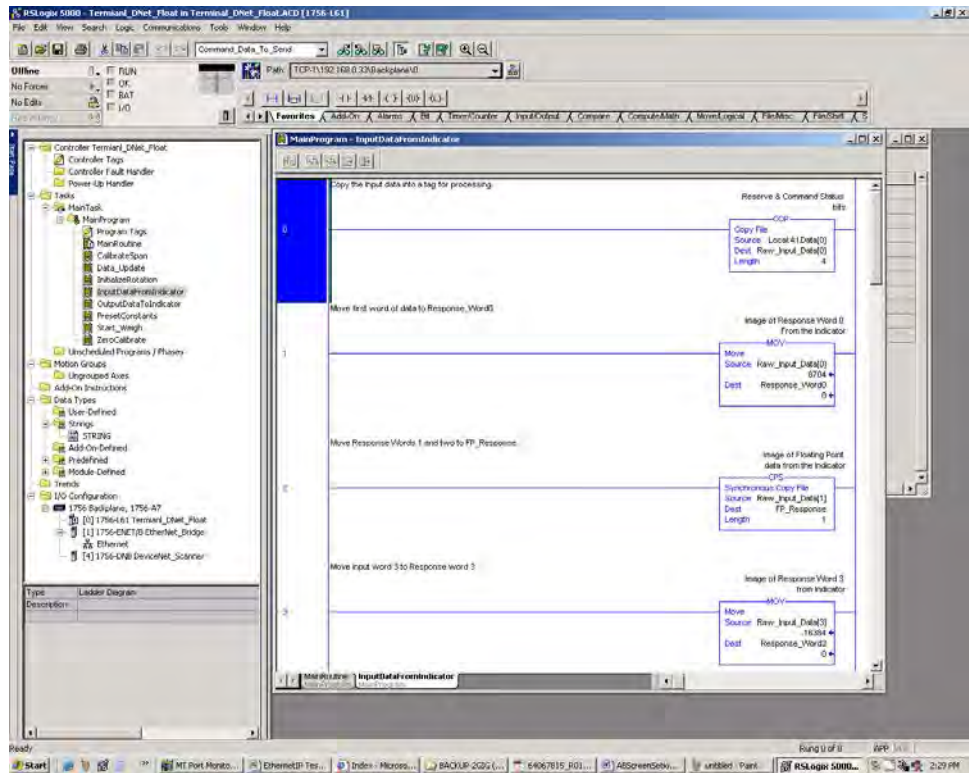

Figure 5-29: DeviceNet – Floating Point Data From the Terminal

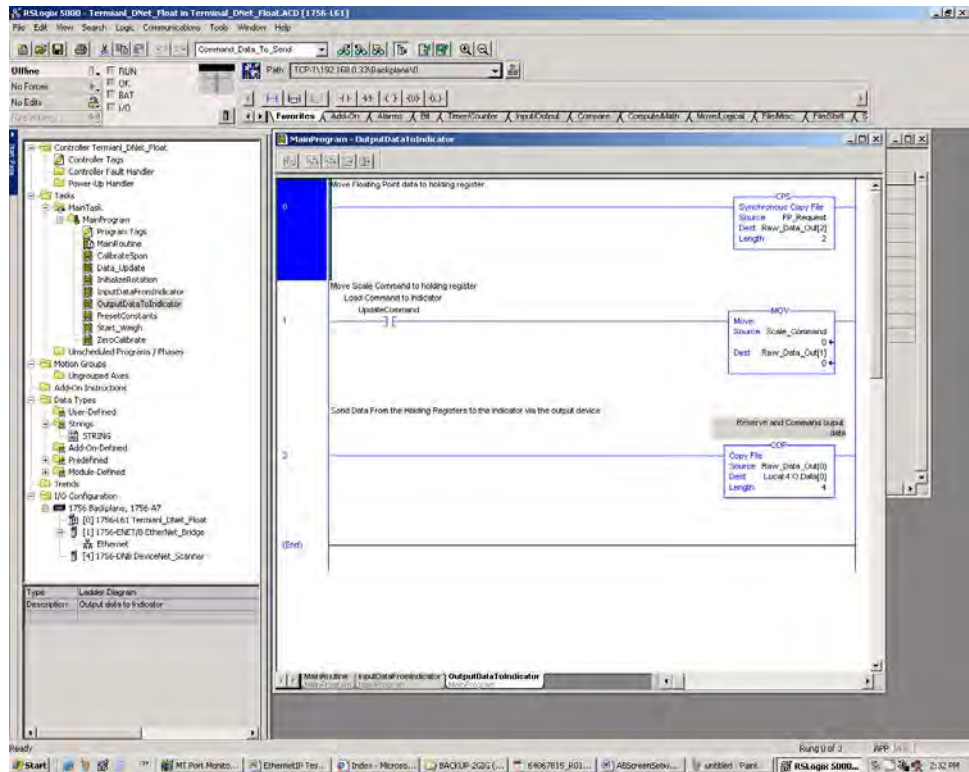

Figure 5-30: DeviceNet –Floating Point Data to the Terminal

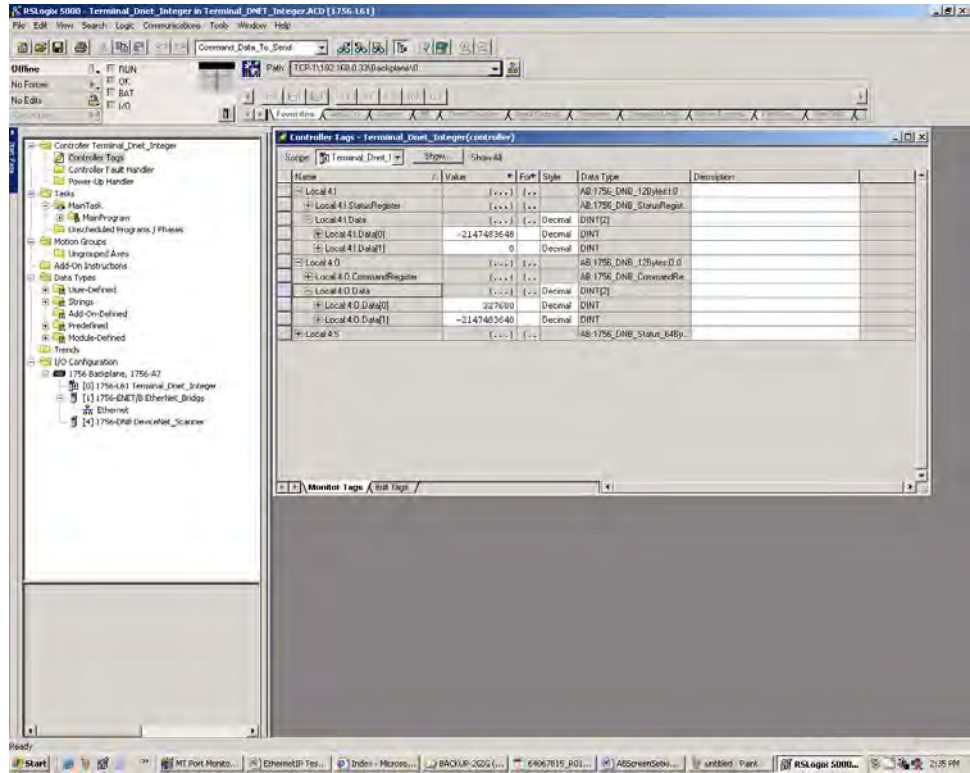

Figure 5-31: DeviceNet Integer/Division Input/Output Tags

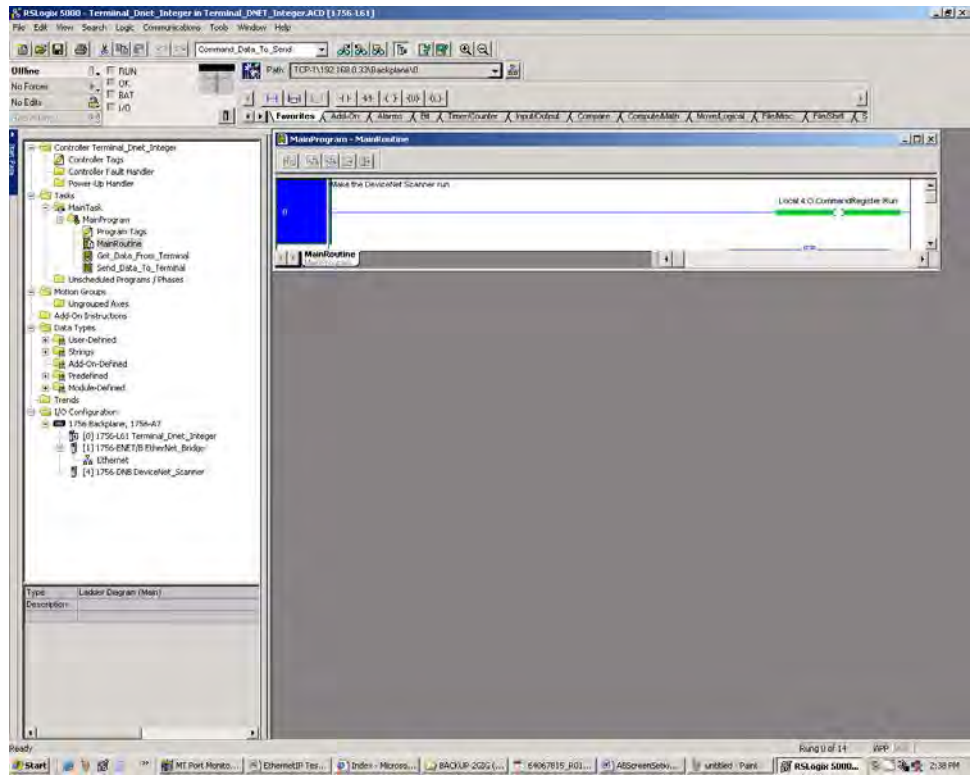

Figure 5-32: DeviceNet Integer/Division Unconditional Rung

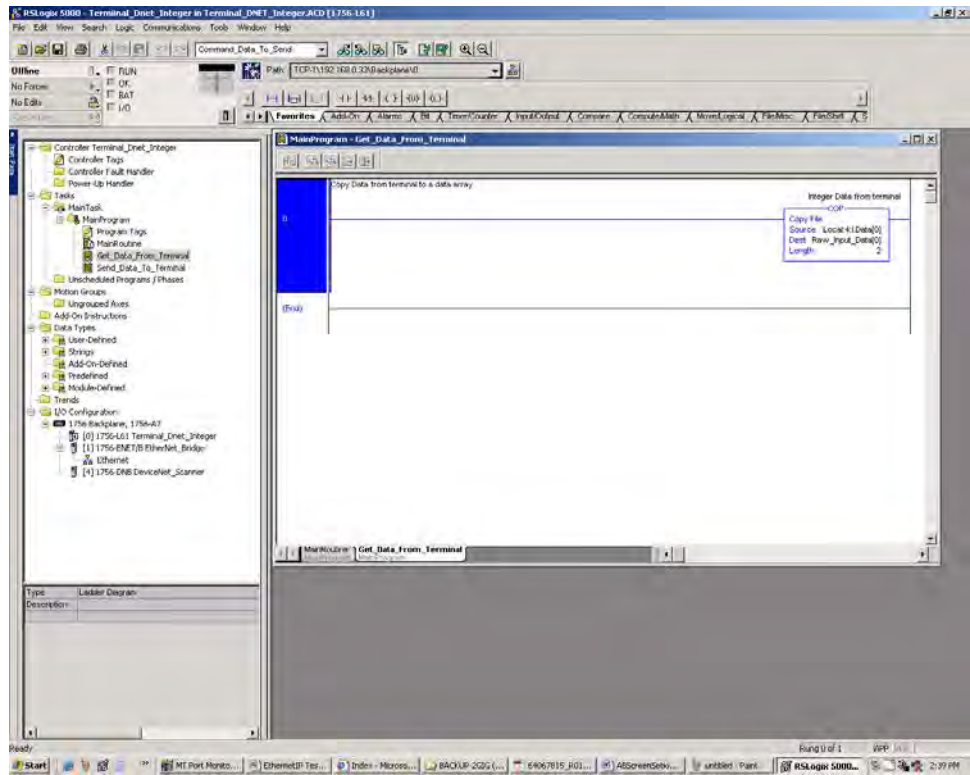

Figure 5-33: DeviceNet Integer/Division Data From Terminal

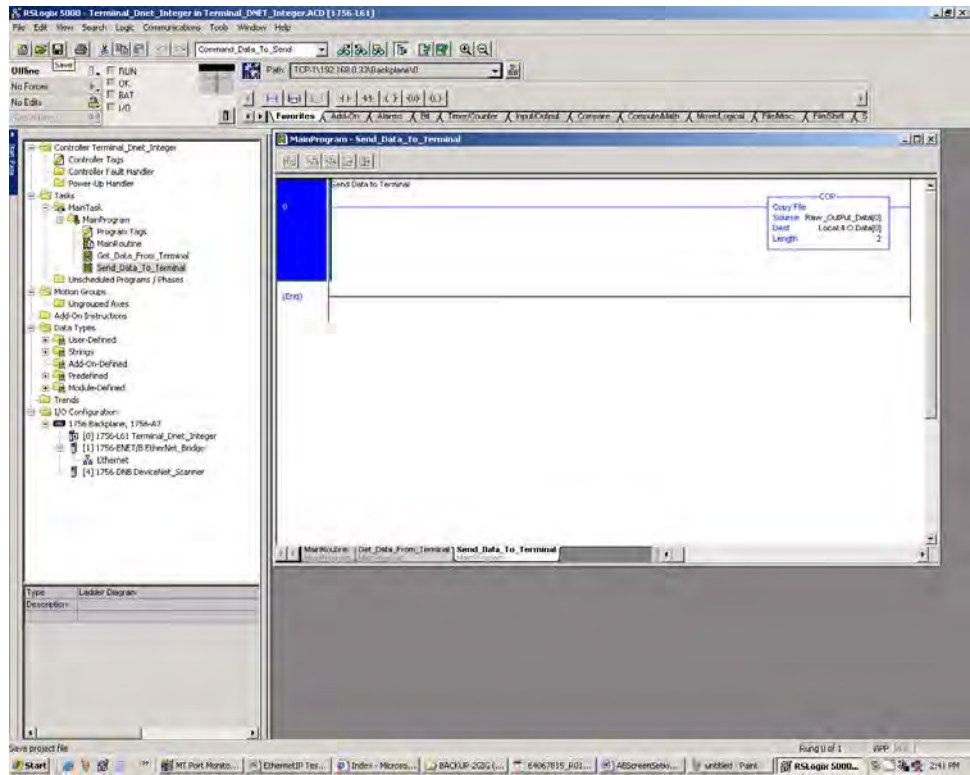

Figure 5-34: DeviceNet Integer/Division Data From Terminal

Chapter 6

EtherNet / IP Option

Overview

This chapter covers

- Overview
- Data Formats
- Hardware Setup
- Software Setup
- Troubleshooting
- Programming Examples

EtherNet/IP, short for "Ethernet Industrial Protocol," is an open industrial networking standard that takes advantage of commercial, off-the-shelf Ethernet communication chips and physical media. This networking standard supports implicit messaging (real-time I/O messaging). Note that only implicit messaging was implemented in the IND131 and IND331 terminals. The protocol is supported by ControlNet International (CI), the Industrial Ethernet Association (IEA) and the Open DeviceNet Vendor Association (ODVA).

EtherNet / IP utilizes commercial, off-the-shelf EtherNet hardware (for example, switches and routers) and is fully compatible with the Ethernet TCP/IP protocol suite. It uses the proven Control and Information Protocol (CIP) to provide control, configuration, and data collection capability.

The EtherNet/IP option enables the IND131/IND331 terminal to communicate to EtherNet/IP Programmable Logic Controllers (PLCs) through direct connection to the EtherNet/IP network at either 10 or 100 Mbps speed. The option consists of an internal module and internal software to implement the data exchange.

The EtherNet/IP option has the following features:

- User-programmable IP addressing.
- Capability for bi-directional discrete mode communications (Class 1 Messaging) of weight or display increments, status, and control data between the PLC and the IND131/IND331.

Figure 6-1 shows an EtherNet/IP module and its components.

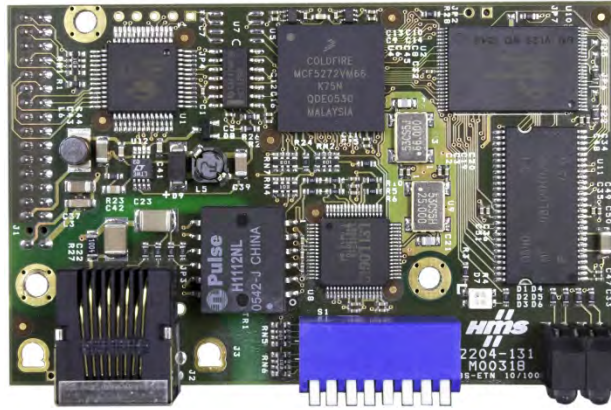

Figure 6-1: EtherNet / IP Module

Definition of Terms

Some terms (such as Target) used by the EtherNet / IP PLC application have a different sense from their use by the IND131/IND331 terminal. Table 6-1 provides definitions specific to EtherNet / IP.

Table 6-1: EtherNet / IP Definition of Terms

Term	Definition
Adapter Class	The IND131/IND331 is an Adapter Class product that emulates functions provided by traditional rack-adapter products. This type of node exchanges real-time I/O data with a Scanner Class product. It does not initiate connections on its own.
Class 1 Messaging	In EtherNet / IP communication protocol scheduled (cyclic) message transfer between a PLC and CIP Adapter Class device.
Class 3 Messaging	This Class is not supported for explicit messaging in the IND131/IND331.
Connected Messaging	A connection is a relationship between two or more application objects on different nodes. The connection establishes a virtual circuit between end points for transfer of data. Node resources are reserved in advance of data transfer and are dedicated and always available. Connected messaging reduces data handling of messages in the node. Connected messages can be Implicit or Explicit . See also Unconnected Messaging .
Connection Originator	Source for I/O connection or message requests. Initiates an I/O connection or explicit message connection.
Explicit Messaging	Explicit Messaging is not supported in the IND131/IND331.
Implicit Messaging	Implicit Messages are exchanged across I/O Connections with an associated Connection ID. The Connection ID defines the meaning of the data and establishes the regular/repeated transport rate and the transport class. No messaging protocol is contained within the message data as with Explicit Messaging. Implicit Messages can be point-to-point or multicast and are used to transmit application-specific I/O data. This term is used interchangeably with the term I/O Messaging .

Term	Definition
I/O Client	Function that uses the I/O messaging services of another (I/O Server) device to perform a task. Initiates a request for an I/O message to the server module. The I/O Client is a Connection Originator .
I/O Messaging	Used interchangeably with the term Implicit Messaging .
I/O Server	Function that provides I/O messaging services to another (I/O Client) device. Responds to a request from the I/O Client. I/O Server is the target of the connection request.
Message Client	Function that uses the Explicit messaging services of another (Message Server) device to perform a task. This is not supported in the IND131/IND331.
Message Server	Function that provides Explicit messaging services to another (Message Client) device. Responds to an Explicit message request from the Message Client.
Scanner Class	A Scanner Class product exchanges real-time I/O data with Adapter Class and Scanner Class products. This type of node can respond to connection requests and can also initiate connections on its own.
Target	Destination for I/O connection or message requests. Can only respond to a request, cannot initiate an I/O connection or message.
Unconnected Messaging	Unconnected Messaging is not supported in the IND131/IND331.

Communications

The IND131/IND331 terminal utilizes component parts to ensure complete compatibility with the Allen-Bradley EtherNet / IP network. An IND131/IND331 terminal is recognized as a generic EtherNet / IP device by the PLC.

The IND131/IND331 uses Class 1 cyclic data for discrete data.

IP Address

Each EtherNet / IP option represents one physical IP Address. This address is chosen by the system designer, and then programmed into the IND131/IND331 terminal and PLC. There is no feature for EtherNet / IP to use a host server to assign addresses. The IND131/IND331 terminal's address is programmed through Communication > PLC Interface > EtherNet / IP in the setup menu. IND131/IND331 IP Address entry must be unique for each IND131/IND331.

Data Formats

The EtherNet / IP option provides discrete data transfer, Class 1 messaging. Data transfer is accomplished via the PLC's cyclic messaging. Discrete data is continuously available. The EtherNet / IP option has its own logical IP address to send and receive information to and from the PLC. There are three data formats: Integer, Divisions, and Floating Point. Refer to Appendix A, **Data Definition**, for details on these formats.

Assembly Instances of Class 1 Cyclic Communications

Class 1 cyclic communications is used for transfer of Discrete Data between the PLC and the IND131/IND331.

The PLC Input Assembly Instance is 100 (decimal). This instance is used for all Data Formats and data size requirements.

The PLC Output Assembly Instance is 150 (decimal). This instance is used for all Data Formats and data size requirements.

The IND131/IND331 uses data only. Configuration data is not used or required. Within the PLC EtherNet / IP Interface setup set the Configuration Instance to 1 and the data size to zero.

The EDS file provided on the Documentation CD has no Assembly Instance or data size limitations. The IND131/IND331 programming controls the Assembly Instance and data size limitations.

Hardware Setup

Figure 6-2 indicates the board's port, DIP switches and status lights.

- Note that the module's address is set in software, and all the DIP switches must be set to OFF.



Figure 6-2: EtherNet / IP Module Components

Wiring

Each EtherNet / IP option connected to the EtherNet / IP network represents a physical IP Address. The connection is made via a RJ-45 connector on the option card (see Figure 6-2).

The wiring between the PLC and the IND131/IND331 EtherNet / IP connection uses EtherNet twisted pair cable. The cable installation procedures and specification including distance and termination requirements are the same as recommended by Allen-Bradley for the EtherNet / IP network.

Software Setup

When the IND131/IND331 terminal detects the presence of a EtherNet / IP Kit option board, the EtherNet / IP parameters are enabled in a Setup program block at Communication > PLC Interface > EtherNet / IP. Figure 6-3 shows the EtherNet / IP setup block.

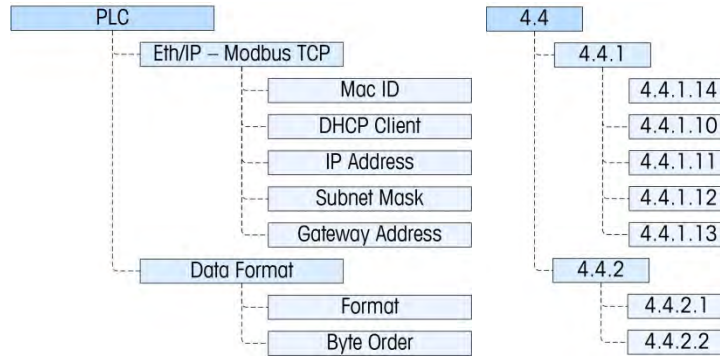

Figure 6-3: EtherNet / IP Setup Block

In this section, figures given in brackets (e.g. [0]) correspond to the parameter options available when F-codes are displayed by the terminal.

EtherNet / IP Setup Block

Ethernet / IP Setup – F4.4.1

Provides access to the DHCP and network address menus used to set up the Ethernet/IP and Modbus TCP option.

Mac ID – F4.4.1.14

The Mac ID of the interface PCB can be viewed.

DHCP Client – F4.4.1.10

This setting determines if the address information for the terminal will be automatically assigned by the network when connected or if a static address will be used. The DHCP can either be **Enabled** [1] or **Disabled** [0] (the default) for the interface.

IP Address – F4.4.1.11

The IP address for the terminal can be viewed (if DHCP is Enabled) or entered (if DHCP is Disabled). The default value is 192-168-000-001.

Subnet Mask – F4.4.1.12

The Subnet Mask address for the terminal can be viewed (if DHCP is Enabled) or entered (if DHCP is Disabled). The default value is 255-255-255-000.

Gateway Address – F4.4.1.13

The Gateway address for the terminal can be viewed (if DHCP is Enabled) or entered (if DHCP is Disabled). The default value is 000-000-000-000.

Data Format Setup – F 4.4.2

Format – F 4.4.2.1

Select the Format from **Division [0]**, **Floating Point [1]** or **Integer [2]** (the default).

Division – reports scale weight in display divisions (± 32767). The PLC multiplies the reported divisions by the increment size to calculate the weight in display units.

Floating Point – displays weight in floating point data format

Integer – reports scale weight as a signed 16 bit integer (± 32767).

Byte Order – F4.4.2.2

This parameter selects the order in which the data bytes and words will be presented in the PLC data format. The choices are **Byte Swap [0]**, **Standard [1]**, **Word Swap [2]** (the default), and **Double Word Swap [3]**.

- **Word Swap** – Takes the IEE 754 single-precision floating point format and swaps the two words in the 32-bit double word. This format is compatible with RSLogix 5000 processors.
- **Byte Swap** – Makes the floating point format compatible with S7 PROFIBUS.
- **Double Word Swap** – Makes the data format compatible with the Modicon Quantum PLC for Modbus TCP networks.
- **Standard** – Makes the data format compatible with PLC5.

Refer to Appendix A, **Data Definition**, for additional information on byte order and data format.

Troubleshooting

The EtherNet/ IP interface card has four status LEDs indicators to indicate communication and fault status of the card. Figure 6-2 indicates the location of these LEDs, and Figure 6-4 shows the array of the LEDs on the card. Table 6-2 explains the meaning of the indicators.

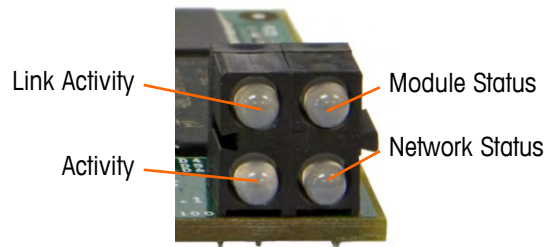

Figure 6-4: Ethernet / IP Status Indicator LEDs

Table 6-2: EtherNet/ IP LEDs Status Indications

LED #	State	Status
1 - Link Activity	Off	No link (or no power)
	Green	Connected to an Ethernet network
2 - Module Status	Off	No power
	Green	Normal operation
	Green, flashing	Stand by, not initialized
	Red	Major fault
	Red, flashing	Minor fault
	Alternating Red/Green	Self test
3 - Network Status	Off	No IP address (or no power)
	Green	EtherNet/ IP connection(s) established
	Green, flashing	No EtherNet/ IP connections established
	Red	Duplicate IP address detected
	Red, flashing	One or several connections timed out
	Alternating Red/Green	Self test
4 - Activity	Off	No Ethernet activity (or no power)
	Green	Receiving or transmitting Ethernet packet

Procedure

If the IND131/IND331 does not communicate with PLC, do the following:

- Check wiring and network termination.
- Confirm that the IND131/IND331 settings for data type, size and IP Address assignment match those in the PLC and that each IND131/IND331 has a unique address.
- If neither of the checks above resolves the issue, contact an authorized METTLER TOLEDO service location.

Programming Examples

The following Figures show sample screen images of ladder logic programming examples for RSLogix 5000 software (version 16).

Note: The Utilities folder of the documentation CD (part number 64067499) contains complete versions of the examples. These screen images are provided for illustrative purposes only.

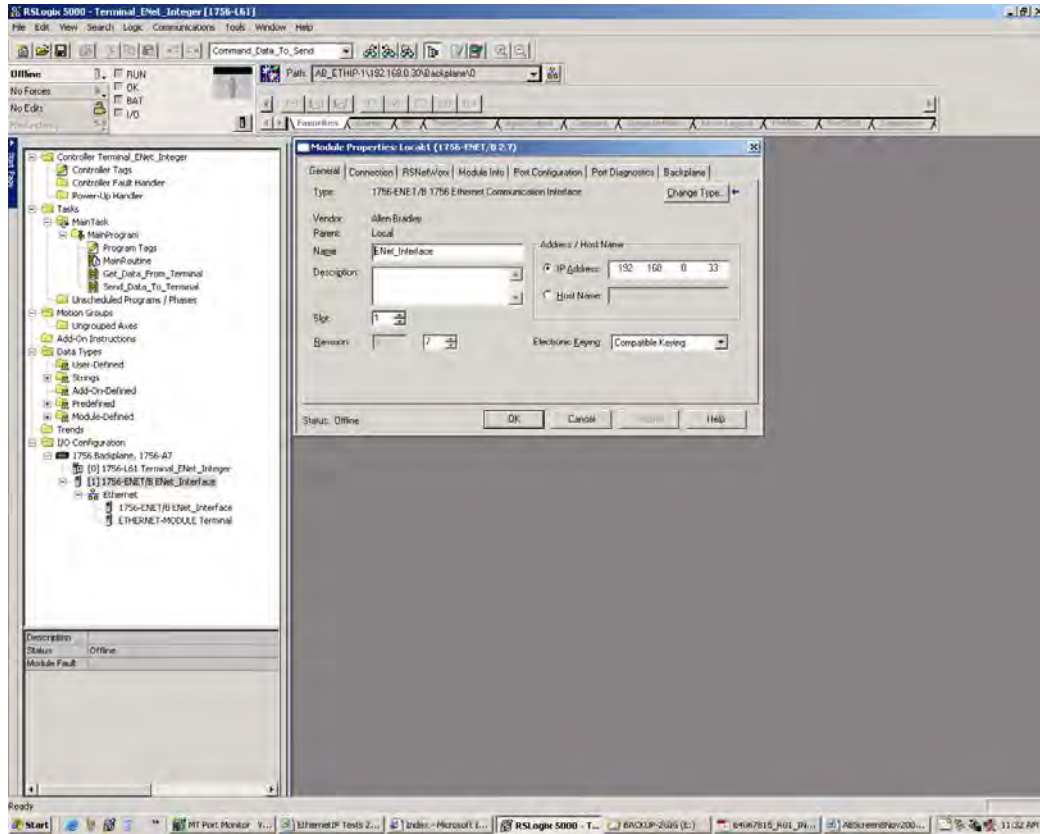

Figure 6-5: EtherNet Bridge in PLC Setup – Integer/Division

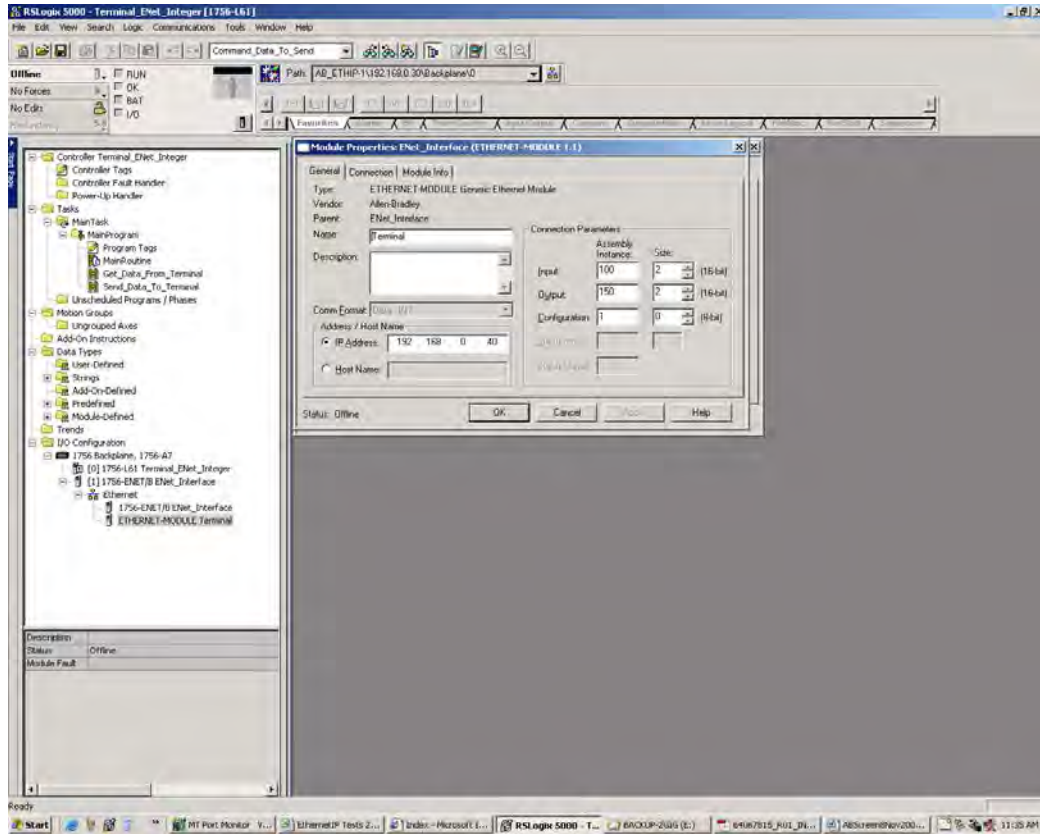

Figure 6-6: EtherNet Module, Integer or Division

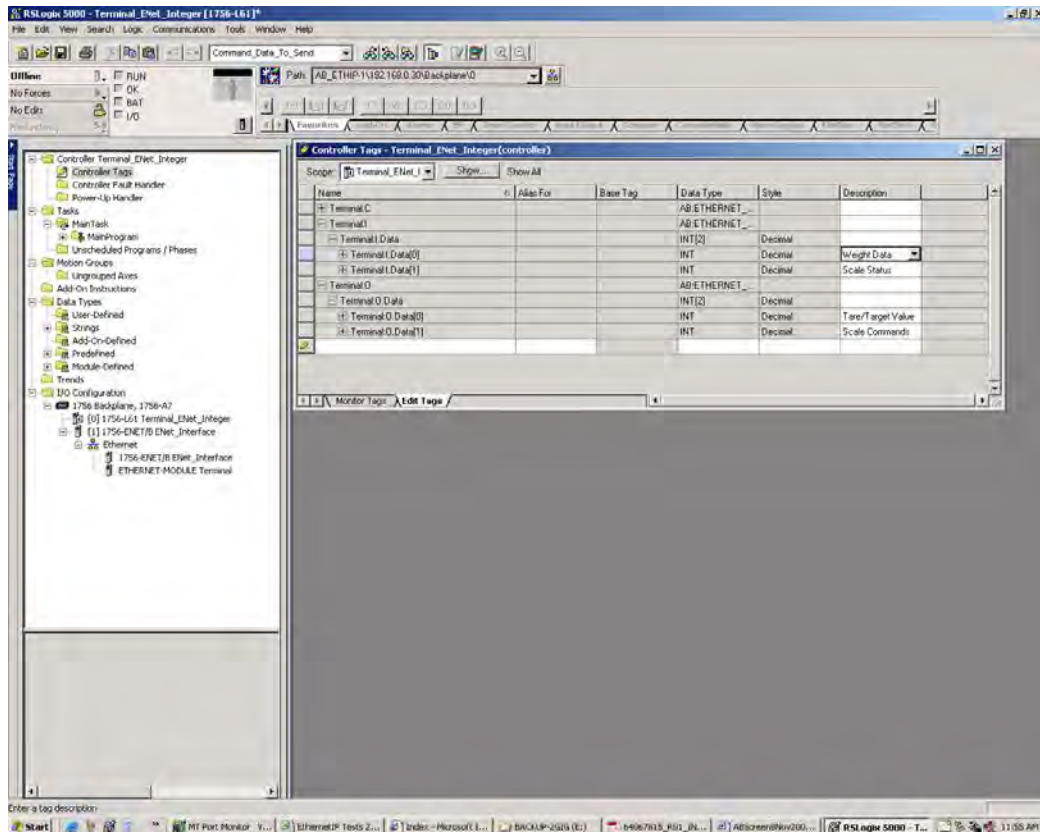

Figure 6-7: EtherNet Module, Integer/Divisions Input/Output Tags

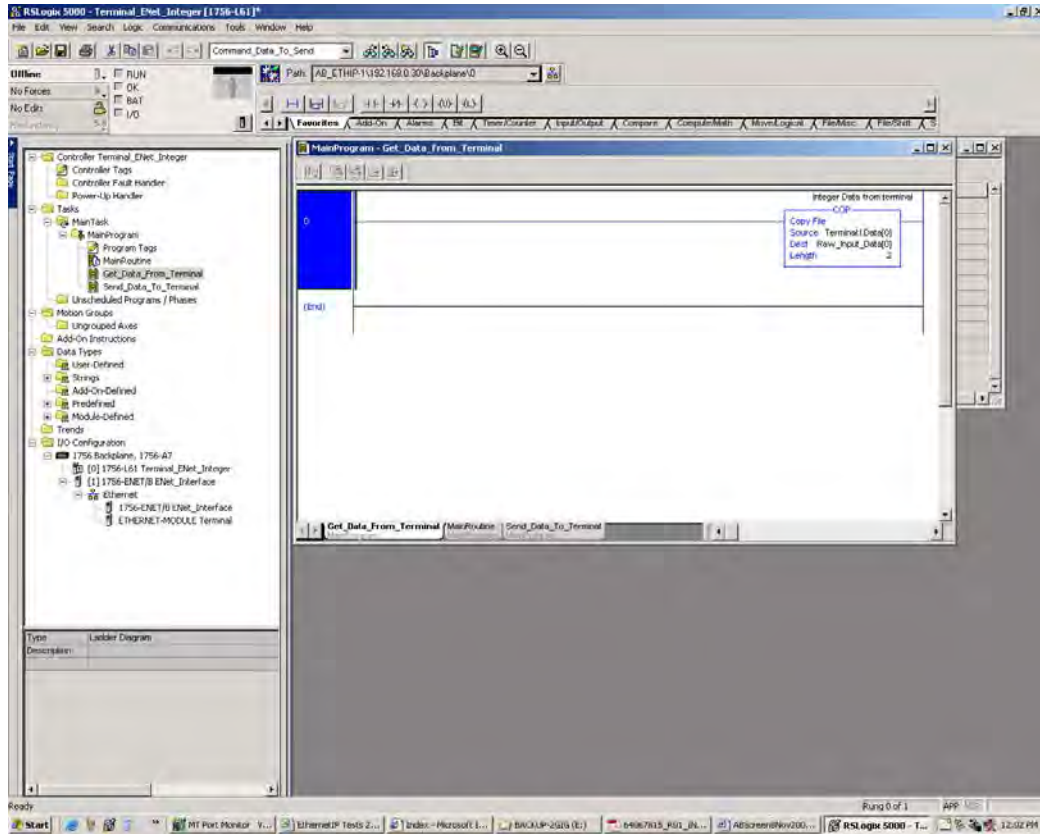

Figure 6-8: EtherNet Module, Integer/Divisions Data Input

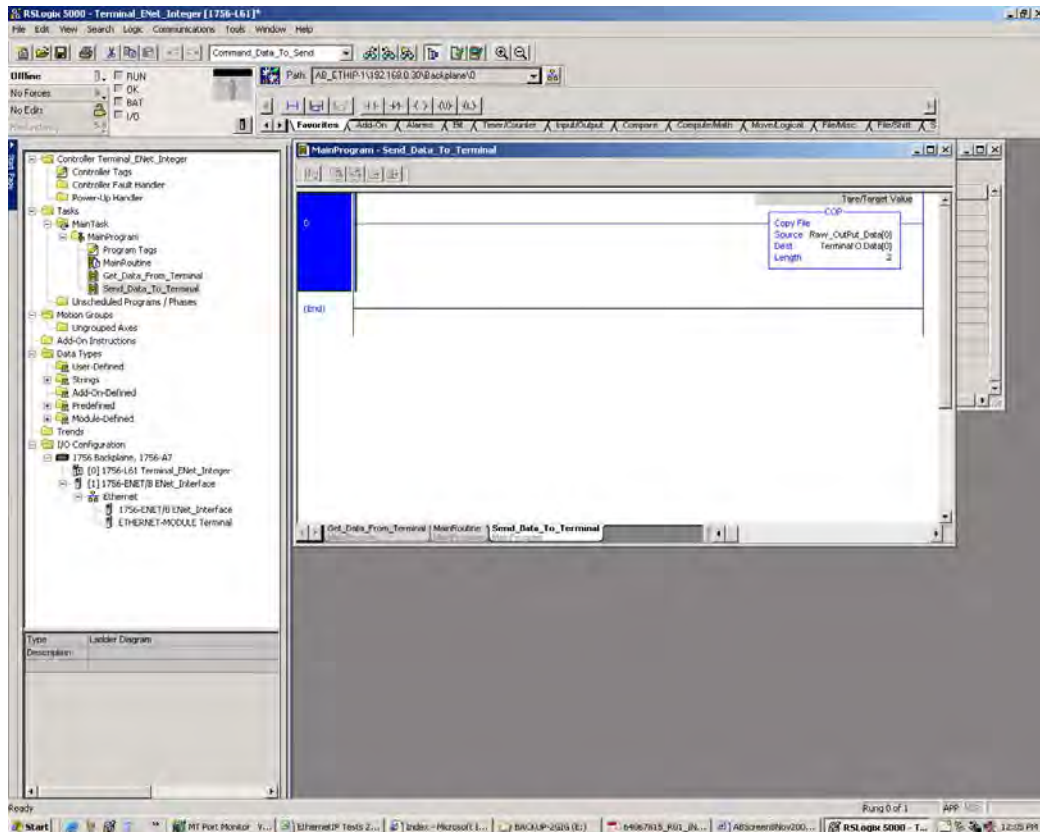

Figure 6-9: EtherNet Module,Integer/Divisions Data Output

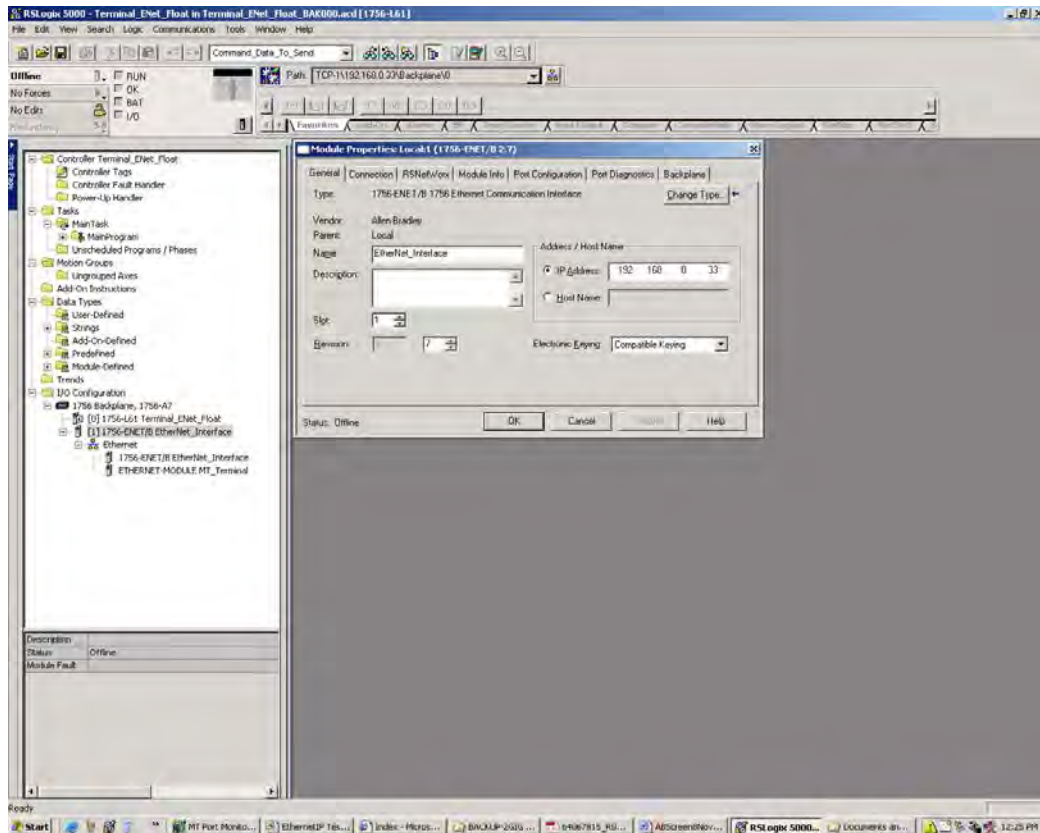

Figure 6-10: EtherNet Bridge in PLC Setup – Floating Point

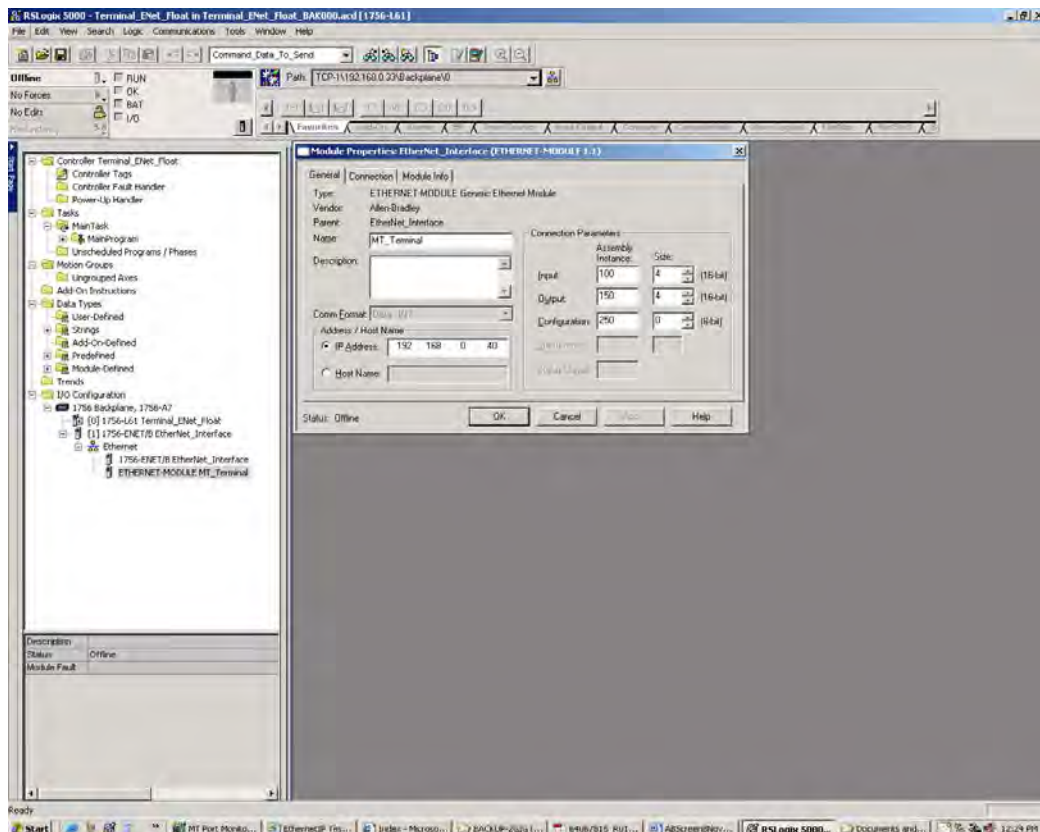

Figure 6-11: Ethernet Module, Floating Point

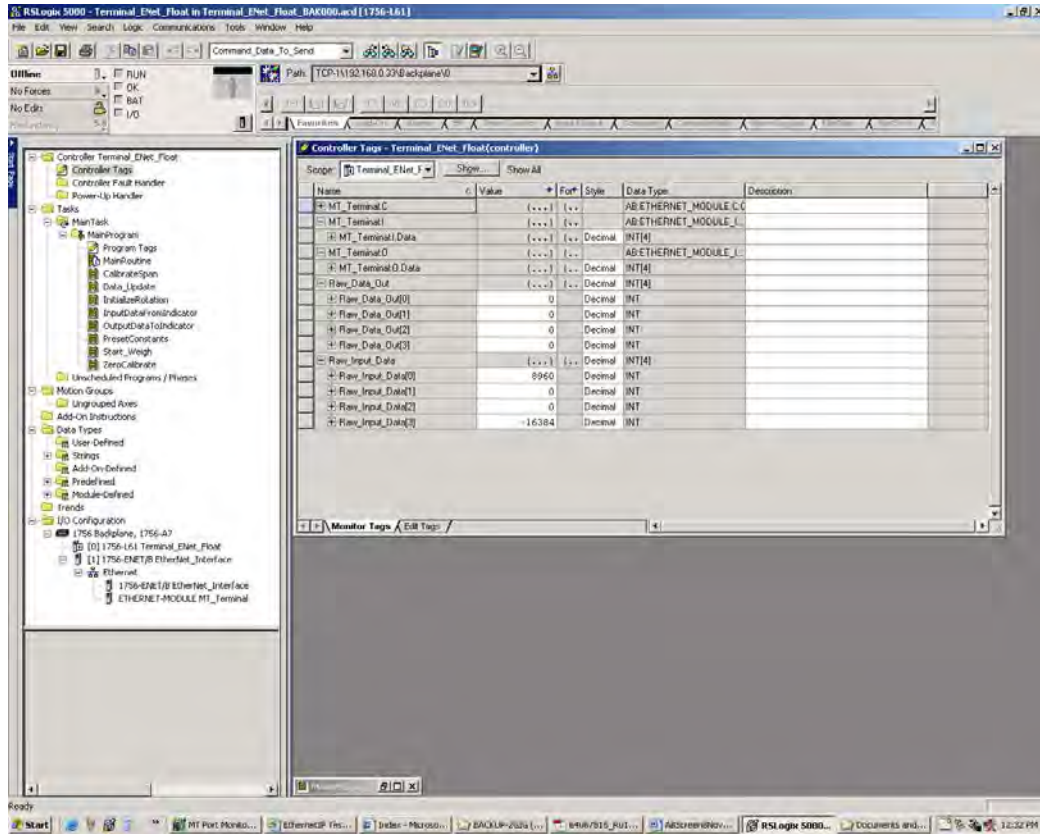

Figure 6-12: EtherNet Module, Floating Point Input/Output Tags

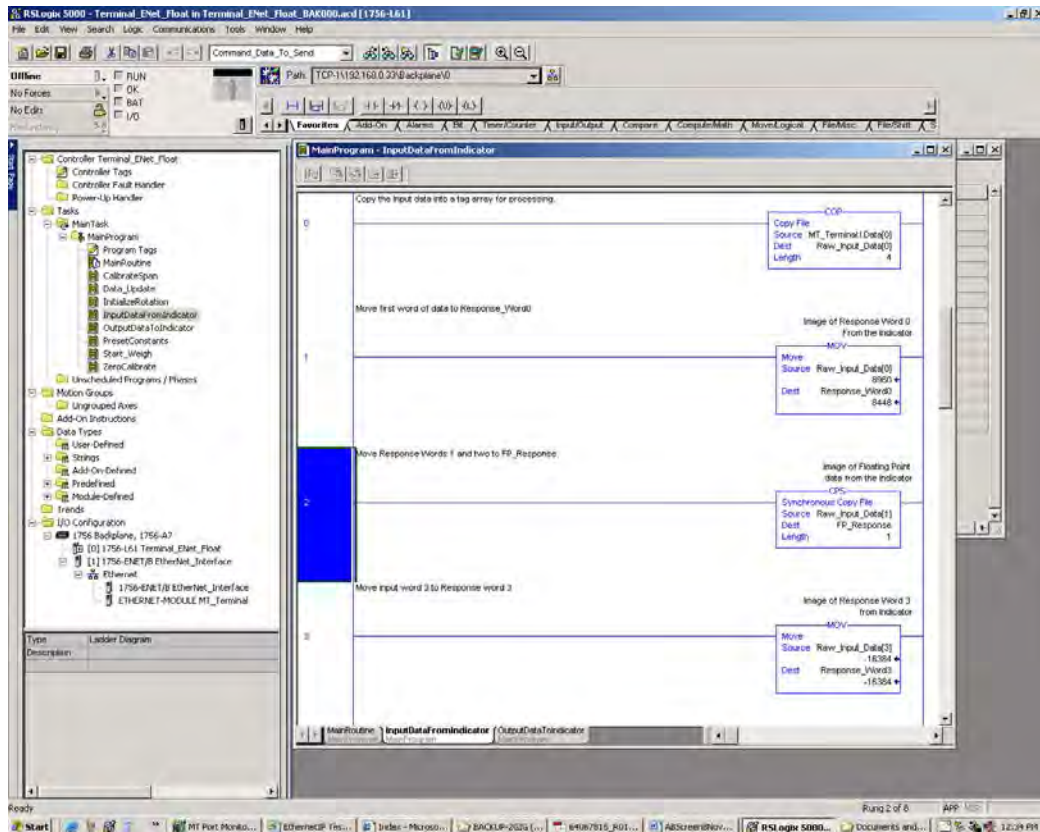

Figure 6-13: EtherNet Module, Floating Point Data Input

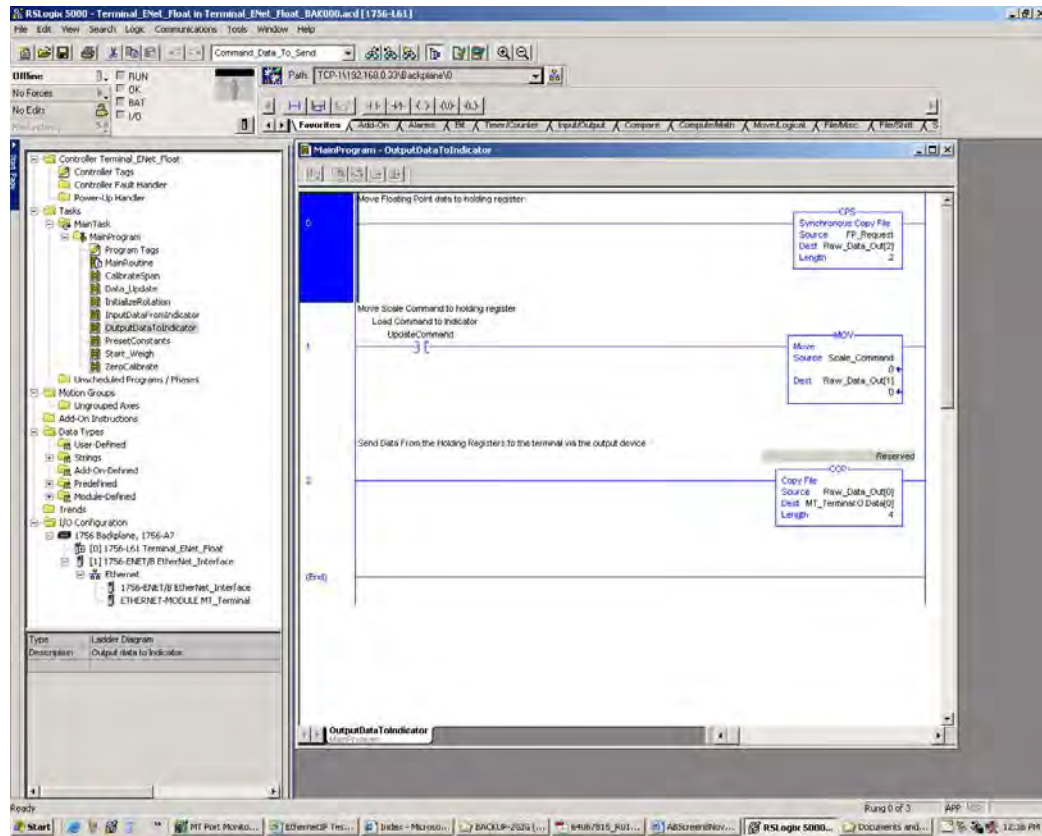

Figure 6-14: EtherNet Module, Floating Point Data Output

Chapter 7

Modbus TCP Option

Overview

This chapter covers

- Overview
- Modbus TCP Characteristics
- Hardware Setup
- Software Setup
- Troubleshooting

For use with the Modbus TCP protocol, the Ethernet / IP board must be revision 1.32 or higher. To determine the revision level of the board, access Information Recall menu [F6] and view the PLC section of the Hardware Information [F6.8].

Modbus protocol is a messaging structure developed by Modicon in 1979. It is used to establish master-slave/client-server communication between intelligent devices. It is an open standard network protocol, widely used in the industrial manufacturing environment. Modbus can be used in multiple master-slave applications to monitor and program devices; to communicate between intelligent devices and sensors and instruments; and to monitor field devices using PCs and HMIs. Modbus is also an ideal protocol for RTU applications where wireless communication is required.

TCP/IP is an Internet transport protocol of that consists of a set of layered protocols, providing a reliable data transport mechanism between machines.

The open Modbus TCP/IP specification was developed in 1999. The Modbus TCP protocol takes the Modbus instruction set and wraps TCP/IP around it.

Specifications

Network Type	Ethernet-TCP/IP based simple Client/Server network.
Topology	Star, tree or line structures; all topologies that can be implemented with standard Ethernet technology, including switched networks, are applicable.
Installation	Standard 10, 100 Mbit/s Ethernet technology based on copper cables, fiber optic or wireless standards can be used. The IND131/IND331 Modbus TCP option provides an RJ-45 Ethernet port connection
Speed	10, 100 Mbit/s.
Max. stations	Nearly unlimited.
Network features	Client/Server network based on standard Ethernet technology and TCP/UDP/IP protocols in Layer 3-4.
User Organization	Modbus-IDA user Group.

Figure 7-1 shows the Modbus TCP Board.

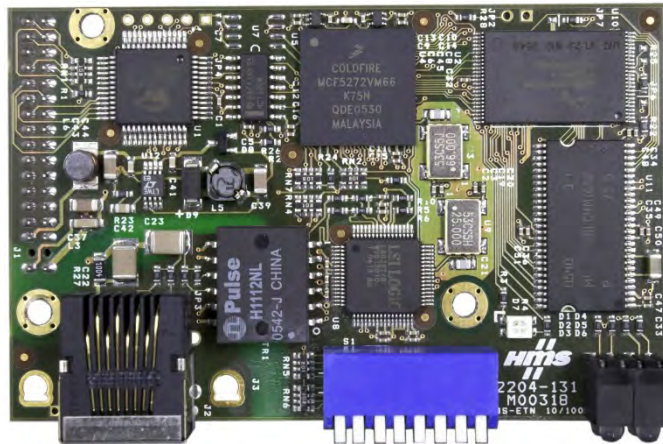

Figure 7-1: Modbus TCP Option Board

Modbus TCP Characteristics

- User-programmable IP addressing
- Capability for bi-directional discrete mode communications (Cyclic Messaging) of weight or display increments, status, and control data between the PLC and the IND131/331.

Communications

The IND131/331 terminal utilizes component parts to ensure complete compatibility with the Modbus TCP network. An IND131/331 terminal is recognized as a generic Modbus TCP device by the PLC.

IP Address

Each Modbus TCP interface option represents one physical IP Address. This address is chosen by the system designer, and then programmed into the IND131/331 terminal and PLC. The IND131/331 terminal's address is programmed through Communication > PLC Interface > Modbus TCP in the setup menu. The IND131/331 IP Address entry must be unique for each IND131/331.

Data Formats

The Modbus TCP Kit option provides discrete data transfer messaging. Discrete data is continuously available. The option has its own logical IP address to send and receive information to and from the PLC. There are three data formats: Integer, Divisions, and Floating Point. Refer to Appendix A, **Data Definition**, for details on these formats.

Hardware Setup

Figure 7-2 indicates the board's port, DIP switches and status lights.

- Note that the module's address is set in software, and all the DIP switches must be set to OFF.

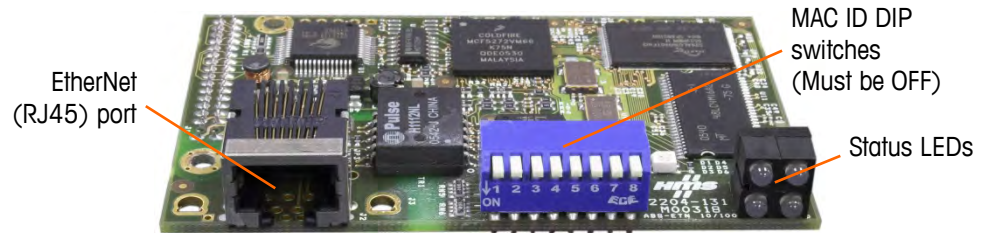

Figure 7-2: Modbus TCP Option Board Components

Wiring

Each Modbus TCP option connected to the network represents a physical IP Address. The connection is made via a RJ-45 connector on the option card (see Figure 7-2).

The wiring between the PLC and the IND131/IND331 Modbus TCP connection uses Ethernet twisted pair cable. The cable installation procedures and specification including distance and termination requirements are the same as recommended by Schneider Electric (Modicon) for the Modbus TCP network.

Software Setup

The IND131/331 terminal automatically detects the presence of a Modbus TCP option board if one is installed. When the option is detected, the IND131/331 terminal enables the Modbus TCP parameters in a program block under Communications > PLC Interface > Ethernet / IP – Modbus TCP. Figure 7-3 shows the Modbus TCP setup block.

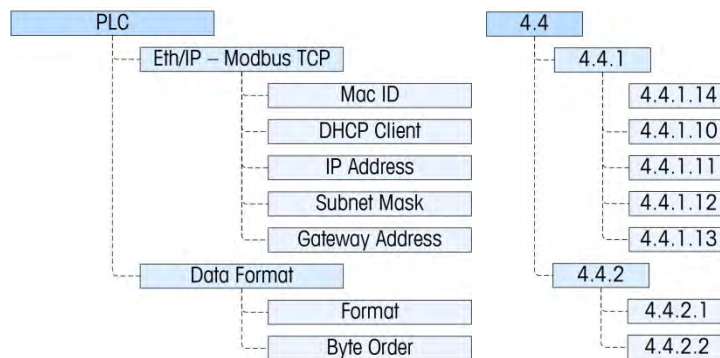

Figure 7-3: The Modbus TCP Setup Block

In this section, figures given in brackets (e.g. [0]) correspond to the parameter options available when F-codes are displayed by the terminal.

Modbus TCP Setup Block

Modbus TCP setup – F4.4.1

The Modbus TCP Setup block allows the interface's IP address, subnet mask and gateway address to be specified and provides access to the DHCP and network address menus used to set up the Ethernet/IP and Modbus TCP option.

Mac ID – F4.4.1.14

The Mac ID of the interface PCB can be viewed.

DHCP Client – F4.4.1.10

This setting determines if the address information for the terminal will be automatically assigned by the network when connected or if a static address will be used. The DHCP can either be **Enabled [1]** or **Disabled [0]** (the default) for the interface.

IP Address – F4.4.1.11

The IP address for the terminal can be viewed (if DHCP is Enabled) or entered (if DHCP is Disabled). The default value is 192-168-000-001.

Subnet Mask – F4.4.1.12

The Subnet Mask address for the terminal can be viewed (if DHCP is Enabled) or entered (if DHCP is Disabled). The default value is 255-255-255-000.

Gateway Address – F4.4.1.13

The Gateway address for the terminal can be viewed (if DHCP is Enabled) or entered (if DHCP is Disabled). The default value is 000-000-000-000.

Data Format Setup – F 4.4.2

Format – F 4.4.2.1

Select the Format from **Division [0]**, **Floating Point [1]** or **Integer [2]** (the default).

Division – reports scale weight in display divisions (± 32767). The PLC multiplies the reported divisions by the increment size to calculate the weight in display units.

Floating Point – displays weight in floating point data format

Integer – reports scale weight as a signed 16 bit integer (± 32767).

Byte Order – F4.4.2.2

This parameter selects the order in which the data bytes and words will be presented in the PLC data format. The choices are **Byte Swap [0]**, **Standard [1]**, **Word Swap [2]** (the default), and **Double Word Swap [3]**.

- **Word Swap** – Takes the IEE 754 single-precision floating point format and swaps the two words in the 32-bit double word. This format is compatible with RSLogix 5000 processors.
- **Byte Swap** – Makes the floating point format compatible with S7 PROFIBUS.
- **Double Word Swap** – Makes the data format compatible with the Modicon Quantum PLC for Modbus TCP networks.
- **Standard** – Makes the data format compatible with PLC5.

Refer to Appendix A, **Data Definition**, for additional information on byte order and data format.

Troubleshooting

The Modbus TCP interface card has four status LEDs indicators to indicate communication and fault status of the card. Figure 7-2 indicates the location of these LEDs, and Figure 7-4 shows the array of the LEDs on the card. Table 7-1 explains the meaning.

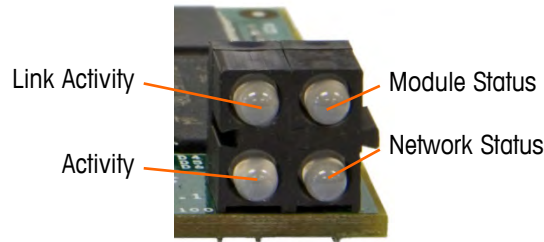

Figure 7-4:– Modbus TCP Board Status LED Array

Table 7-1: Modbus TCP LED Status Indications

LED #	State	Status
1 - Link Activity	Off	No link (or no power)
	Green	Connected to an Ethernet network
2 - Module Status	Off	No power
	Green (1 Hz flash)	IP address not set via switch
	Red (1 Hz flash)	Invalid MAC address (internal error)
	Red (2 Hz flash)	Failed to load Ethernet configuration
	Red (4 Hz flash)	Fatal internal error
	Red	Duplicate IP address detected
3 - Network Status	This LED indicates the number of established Modbus/TCP connections to the terminal. The number of established connections is equal to the number of “blinks” or “flashes” on this LED.	
4 - Activity	Off	No Ethernet activity (or no power)
	Green, flashing	Flashes green each time a packet is received or transmitted

Procedure

If the IND131/IND331 does not communicate with PLC, do the following:

- Check wiring and network termination.
- Confirm that the IND131/IND331 settings for data type and IP Address assignment match those in the PLC and that each IND131/IND331 has a unique address.
- If neither of the checks above resolves the issue, contact an authorized METTLER TOLEDO service location.

Chapter 8

PROFIBUS Option

Overview

This chapter covers

- Overview
- Data Formats
- Hardware Setup
- Software Setup
- Troubleshooting
- Interfacing Examples

The PROFIBUS option card enables the IND131/331 terminal to communicate to a PROFIBUS DP master according to DIN 19245. It consists of an IND131/331 terminal module and software that resides in the terminal, which implements the data exchange.

The PROFIBUS option card interfaces to programmable logic controllers (PLCs) such as Texas Instruments 505 series, Siemens S5 series, and Siemens S7 series PLCs. The PROFIBUS appears as a block of I/O on the PROFIBUS network. The size and mapping of the I/O depends on the setup of the PROFIBUS card at the IND131/331.

The data mapped within the I/O block is defined as discrete. Based upon the IND131/331 setup, discrete data is selected as Integer, Division, or Floating Point.

Discrete data is sent in groups defined as a message block. While the format of each message block is the same, the data received and displayed within a message block is dependant on the commands within the block.

The Texas Instruments (TI) 505 PLCs interfaces to the PROFIBUS via an I/O processor called a Field Interface Module (FIM). The FIM bus master recognizes a fixed set of PROFIBUS slave devices, all of which are viewed by it as some sort of remote I/O rack. On power up, the FIM queries each PROFIBUS slave node to determine which of the recognized types a device might be and configures itself accordingly. The PROFIBUS option appears to the FIM to be a small ET200U I/O rack.

The Siemens S5-115 series PLC also interfaces to the PROFIBUS using an I/O processor, an IM-308. This device must be locally programmed with the terminal interface type files. Newer Siemens S7 PLCs have the PROFIBUS option on their main controller card.

Figure 8-1 shows the PROFIBUS interface board.

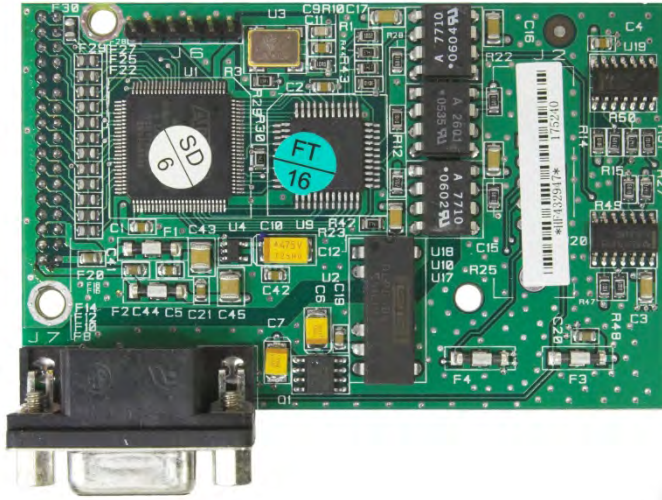

Figure 8-1: PROFIBUS Kit Option Board

Communications

PROFIBUS is based on a variety of existing national and international standards. The protocol architecture is based on the Open Systems Interconnection (OSI) reference model in accordance with the international standard ISO 7498.

The IND131/331 terminal supports the PROFIBUS-DP which is designed for high-speed data transfer at the sensor actuator level. (DP means Distributed Peripherals.) At this level, controllers such as PLCs exchange data via a fast serial link with their distributed peripherals. The data exchange with these distributed devices is mainly cyclic. The central controller (master) reads the input information from the slaves and sends the output information back to the slaves. It is important that the bus cycle time is shorter than the program cycle time of the controller, which is approximately 10 ms in most applications. The following is a summary of the technical features of the PROFIBUS-DP communications protocol:

Transmission Technique

- PROFIBUS DIN 19245 Part 1
- EIA RS 485 twisted pair cable or fiber optic
- 9.6 kbit/s up to 12 Mbit/s, max distance 200 m at 1.5 Mbit/s extendible with repeaters
- 12 megabaud maximum rate

Medium Access

- Hybrid medium-access protocol according to DIN 19245 Part 1
- Mono-Master or Multi-Master systems supported
- Master and Slave Devices, max 126 stations possible

Communications

- Peer-to-Peer (user data transfer) or Multicast (synchronization)
- Cyclic Master-Slave user data transfer and acyclic Master-Master data transfer

Operation Modes

- Operate: Cyclic transfer of input and output data
- Clear: Inputs are read and outputs are cleared
- Stop: Only master-master functions are possible

Synchronization

- Enables synchronization of the inputs and/or outputs of all DP-Slaves
- Sync-Mode: Outputs are synchronized
- Freeze-Mode: Inputs are synchronized

Functionality

- Cyclic user data transfer between DP-Master(s) and DP-Slave(s)
- Activation or deactivation of individual DP-Slaves
- Checking of the configuration of the DP-Slaves
- Powerful diagnosis mechanisms, three hierarchical levels of the diagnosis
- Synchronization of inputs and/or outputs
- Address assignment for the DP-Slaves over the bus
- Configuration of the DP-Master (DPM1) over the bus
- Maximum 246 byte input and output data per DP-Slave, typical 32 byte

Security and Protection Mechanisms

- All messages are transmitted with Hamming Distance $HD=4$
- Watch-Dog Timer at the DP-Slaves
- Access protection for the inputs/outputs at the DP-Slaves
- Data transfer monitoring with configurable timer interval at the DP-Master (DPM1)

Device-Types

- DP-Master Class 2 (DPM2) for example, programming/configuration device
- DP-Master Class 1 (DPM1) for example, central controller like PLC, CNC, or RC
- DP-Slave for example, Input/Output device with binary or analog inputs/outputs, drives

Cabling and Installation

- Coupling or uncoupling of stations without affecting other stations
- Proven and easy to handle two conductor transmission technique

Node Address

Each IND131/331 PROFIBUS option card represents one physical node. The node address is chosen by the system designer and then programmed into the IND131/331 and PLC. The IND131/331's node address is programmed in Setup at Communication > PLC/Profibus/Node Address.

Data Formats

The terminal's PROFIBUS option card has three data format selection: Integer, Division and Floating Point. Refer to Appendix A, **Data Definition**, for details on these formats.

PROFIBUS GSD or Type Files

There are two configurations within the PROFIBUS GSD or type file for the two different configurations of data format selectable in the IND131/331 terminal. The length of the messages is different for the data formats, but the length of the input and output messages are the same within each format.

- The PROFIBUS GSD files for the IND131/331 are available free of charge. They are included on the documentation CD part number 64067499.

Hardware Setup

Wiring

The IND131/331 terminal's PROFIBUS option card has a DB-9 connector to connect to the PROFIBUS network interface. The wiring termination is listed in Table 8-1. Cable distance, cable type, and termination are specified by PROFIBUS. (Refer to the PLC documentation for cable design guidelines for the various PLCs.)



Figure 8-2: PROFIBUS Option Card DB-9 Connector

Table 8-1: PROFIBUS Wiring Termination

Pin	Signal
1	Not used
2	Not used
3	TxD + and RxD +

Pin	Signal
4	RTS
5	Bus Ground
6	Bus +5V
7	Not used
8	TxD – and RxD –
9	Not used

- The IND131/331 harsh and J-box enclosures require a right angle connector Siemens part number 6ES7 972-0BA41-OXA0. The DIN and panel-mount enclosures can use the right angle connector or a straight connector METTLER TOLEDO part number 64054361.

Software Setup

The IND131/331 terminal automatically detects the presence of a PROFIBUS option card if one is installed, and adds the PROFIBUS setup parameters to the PLC options block. To configure the terminal for PROFIBUS, enter Setup and advance to the Communications > PLC > PROFIBUS sub-block (Figure 8-3).

- You must enter setup and configure with the terminal to communicate on the PROFIBUS network.

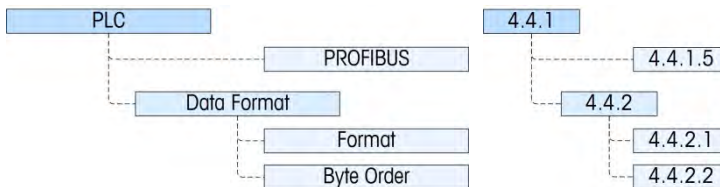

Figure 8-3: PROFIBUS Setup Block

In this section, figures given in brackets (e.g. [0]) correspond to the parameter options available when F-codes are displayed by the terminal.

PROFIBUS Setup Sub-Block

The PLC Setup block lets you specify how the PROFIBUS interface is used. Several options are available to correspond with your system setup.

PROFIBUS Setup – F4.4.1

Provides access to the node address for the terminal. Note that the network baud rate is automatically determined by the terminal.

Node Address – F4.4.1.5

Each IND131 or IND331 Terminal connected to the network represents one physical node. This address is determined by the system designer, then configured in the terminal by entering the appropriate number (1 to 125) in the Node Address menu.

Data Format Setup – F4.4.2

Provides access to the Format and Byte Order parameters.

Format – F4.4.2.1

The Format menu allows a data format to be selected from a list. Options are **Division** [0], **Floating Point** [1] and **Integer** [2] (the default).

Division – displays scale weight in display divisions. The PLC multiplies the display divisions by the increment size to calculate the weight in display units.

Floating Point – displays weight in floating point data format

Integer – displays scale weight as a signed 16 bit integer (± 32767)

Byte Order – F4.4.2.2

This parameter selects the order in which the data bytes and words will be presented in the PLC data format. The choices are **Byte Swap** [0] (the default), **Standard** [1], **Word Swap** [2], and **Double Word Swap** [3].

- **Word Swap** – Takes the IEE 754 single-precision floating point format and swaps the two words in the 32-bit double word. This format is compatible with RSLogix 5000 processors.
- **Byte Swap** – Makes the floating point format compatible with S7 PROFIBUS.
- **Double Word Swap** – Makes the data format compatible with the Modicon Quantum PLC for Modbus TCP networks.
- **Standard** – Makes the data format compatible with PLC5.

Refer to Appendix A, **Data Definition**, for additional information on byte order and data format.

Troubleshooting

Procedure

If the IND131/331 does not communicate with PLC, do the following:

- Check wiring and network termination.
- Confirm that the IND131/331 settings for address, format and byte order match those in the PLC and that each IND131/331 has a unique address.

- If neither of the checks above resolves the issue, contact an authorized METTLER TOLEDO service location.

Integer/Division Interfacing Examples

Figure 8-4 and Figure 8-5 show sample screens of hardware setup and I/O monitoring of the IND131/331 in the Siemens Step 7 software. The documentation CD, part number 64067499, contains complete versions of these examples.

- The IND131/331 PLC Format is set to Integer or Division
- The IND131/331 PLC Byte Order is set to Byte Swap
- I/O 2 Word is selected
- Input word PIW256 is assigned to Integer/Division Response Word 0, PIW258 is assigned to Response Word 1
- Output Word PQW256 is assigned to Integer/Division Request Word 1, PQW258 is assigned to Request Word 1

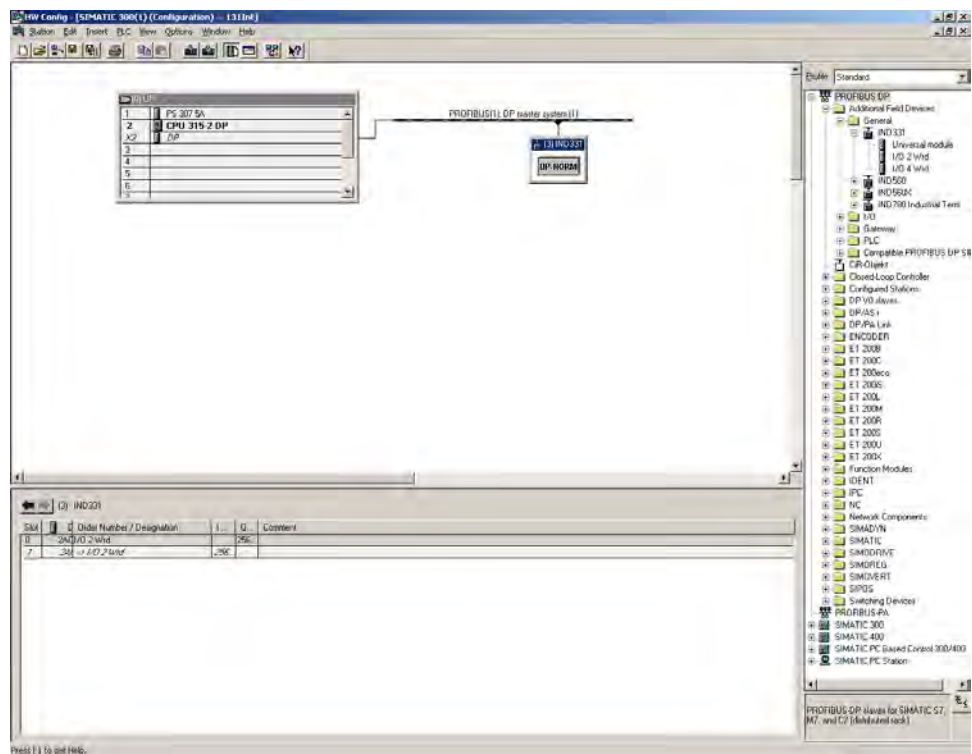

Figure 8-4: Integer/Division Hardware Setup

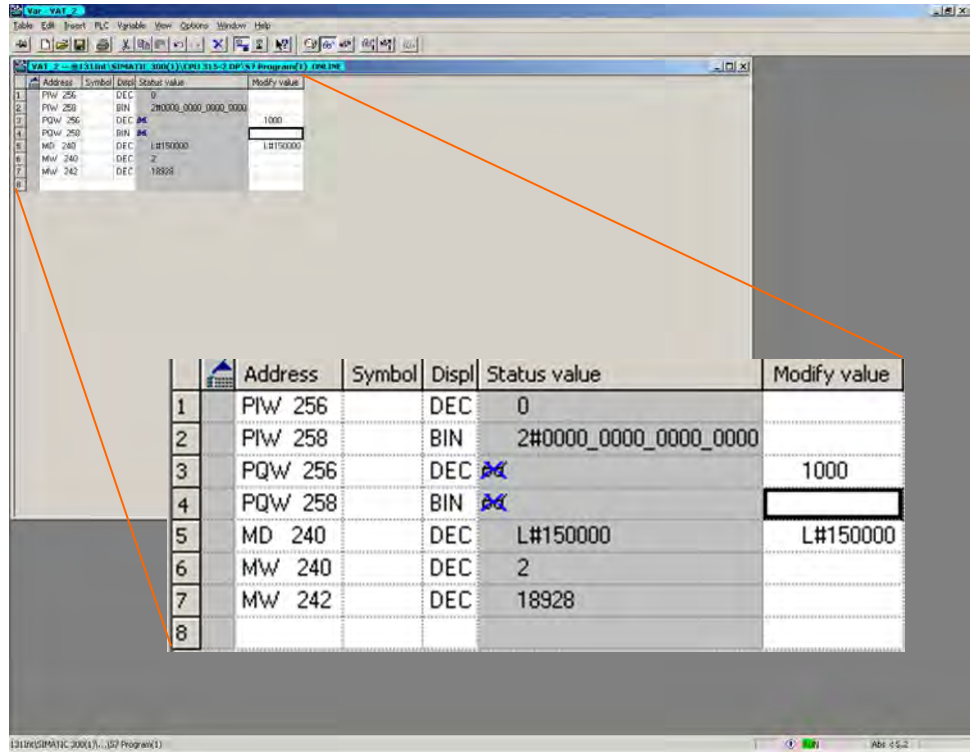

Figure 8-5: Integer/Division I/O Monitoring

Floating Point Interfacing Examples

Figure 8-6 and Figure 8-7 show sample screens of hardware setup and I/O monitoring of the IND131/331 in the Siemens Step 7 software. The documentation CD, part number 64067499, contains complete versions of these examples.

- The IND131/331 PLC Format is set to Floating Point
- The IND131/331 PLC Byte Order is set to Byte Swap
- I/O 4 Word is selected

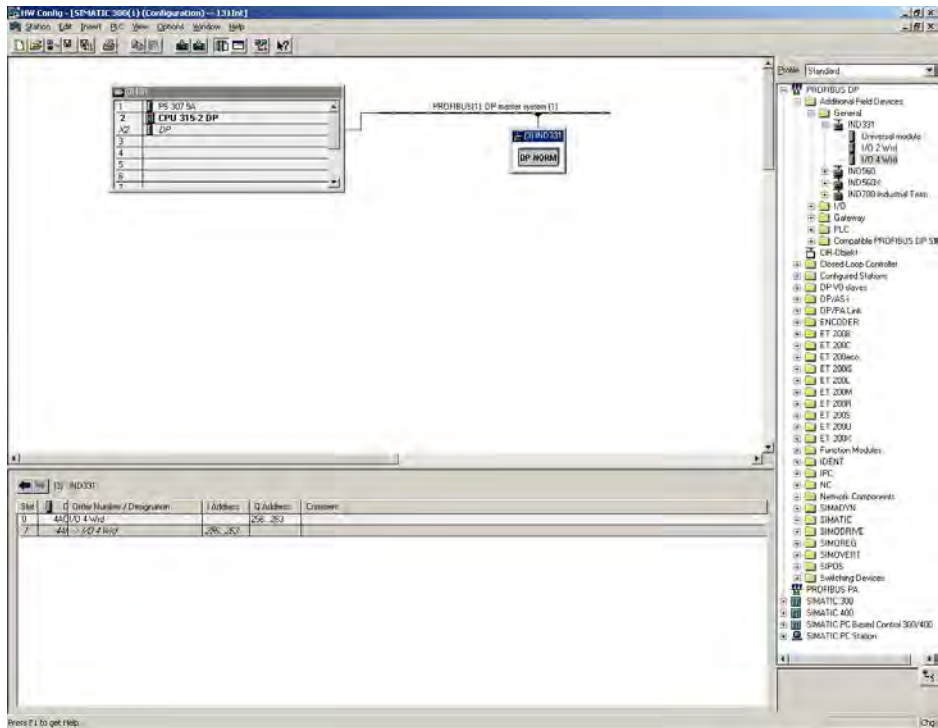

Figure 8-6: Floating Point Hardware Setup

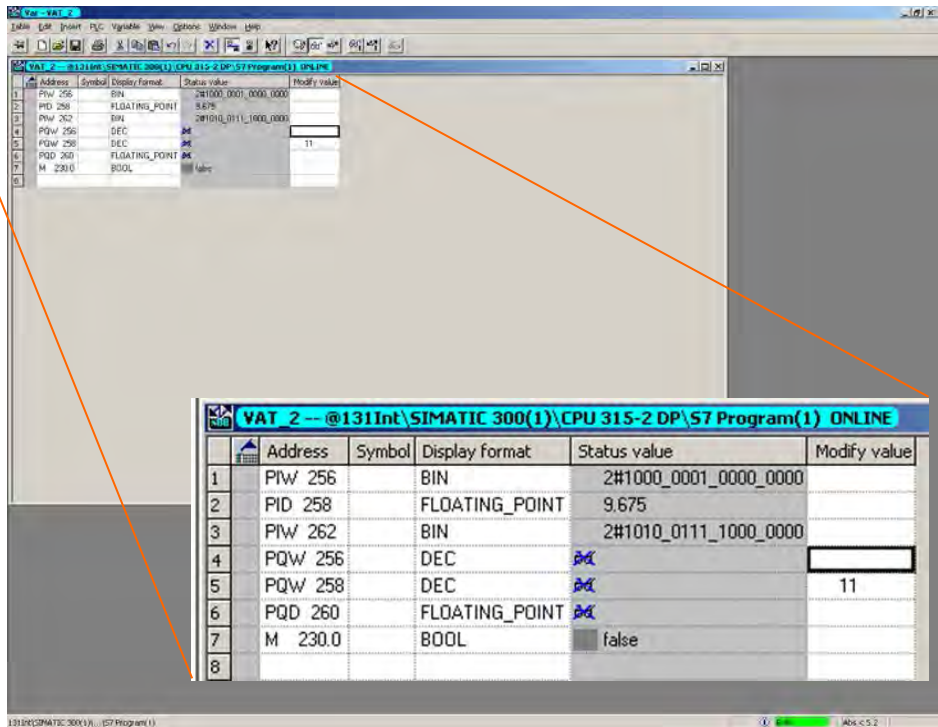

Figure 8-7: Floating Point I/O Monitoring

- Input word PIW256 is assigned to Response Word 0, PID258 is assigned to Response Words1 and 2, PIW 262 is assigned to Response Word 3.
- Output Word PQW256 is assigned to Request Word 0, PQW258 is assigned to Request Word1, PQD260 is assigned to Request Words 2 and 3.

Appendix A

Data Definition

Overview

This Appendix covers

- Overview
- Data Formats
- Message Size
- Byte Order
- Data Integrity
- Format Details
- Floating Point Command Examples
- Controlling the Discrete IO

This appendix describes the details of the data structure used in the **A-B RIO, ControlNet, DeviceNet, Ethernet/IP, Modbus TCP** and **PROFIBUS** PLC interfaces. The same data exchange is provided regardless of the type of PLC interface selected.

Some interfaces have special details regarding their operation also included in this Appendix.

Data Formats

Each PLC interface supports three types of data formats: Integer, Divisions, and Floating Point.

- **Integer** – reports scale weight as a signed 16 bit integer (± 32767).
- **Divisions** – reports scale weight in display divisions (± 32767). The PLC multiplies the reported divisions by the increment size to calculate the weight in display units.
- **Floating Point** – displays weight in floating point data format

Only one type of data format may be selected and used at one time by the IND131/IND331 terminal. The format is selected in setup.

Selection of the appropriate format depends on issues such as the range or capacity of the scale used in the application. The integer format can represent a numerical value up to 32,767. The division format can represent a value up to 32,767 scale divisions or increments. The floating-point format can represent a value encoded in IEEE 754, single precision floating point format.

Example 1:

250 x 0.02 scale				
IND131/IND331 Displays:	0	2.00	51.68	250.00
Format sent:				
Integer	0	200	5168	25000
Division	0	100	2584	12500
Floating Point	0	2.00	51.68	250.00

Any of the formats could be used in this case.

Example 2:

50,000 x 10 scale				
IND131/IND331 Displays:	0	200	5160	50000
Format sent:				
Integer	0	200	5160	-(15536)
Division	0	20	516	5000
Floating Point	0	200	5160	50000

The integer format could not be used because it would send a negative value once the weight exceeded 32,767.

Example 3:

100 x 0.001 scale				
IND131/IND331 Displays:	0	2.100	51.607	90.000
Format sent:				
Integer	0	2100	-(13929)	(24464)
Division	0	2100	-(13929)	(24464)
Floating Point	0	2.100	51.607	90.000

The integer and division formats could not be used because they would send a negative value once the weight exceeded 32.767.

Floating point is the only format that includes decimal point information as a part of its data. All other formats ignore decimal points. Accommodation of decimal point location must take place in the PLC logic, when it is needed with these formats.

Another issue is the type of information communicated between the IND131/IND331 and PLC for the application. Because the floating point format has more space for its data, it has additional information that can be sent or received. Refer to the detailed description of each format and the data available to determine which is most suitable for the specific application.

The format selected for the data format will affect the amount of logical PLC space required. Integer and division formats require two 16-bit words of input and two 16-bit words of output data. The floating-point format requires more space per IND131/IND331 because floating point data uses two 16-bit words of data to represent just the numeric data alone. The floating point format uses four 16-bit words of input and four 16-bit words of output data.

Data format is set up at Communication > PLC > Data Format.

Message Size

The integer and division formats allow bi-directional communication of discrete bit encoded information or 16 bit binary word numerical values. The IND131/IND331 typically provides four bytes (2 words) of data in the Integer or Divisions format except the ControlNet interface provides eight bytes (4 words) of input data to the PLC.

The floating-point format allows bi-directional communication of discrete bit encoded information or numeric data encoded in IEEE 754, single precision floating point format. The IND131/IND331 provides eight bytes (4 words) of data in the Floating Point format.

Integer and Division

The first input word (Word 0) provides scale weight or rate data to the PLC. The second input word (word 1) provides scale status information. Table A-1 shows the input usage information for the Integer and Divisions modes. The Modbus TCP interfaces register addresses are listed as a reference for that interface.

Table A-1: PLC Input Data and Data Usage (Integer and Division)

PLC Input Bytes	PLC Input Words	Modbus Register	Usage
0	0	400001	Weight Data
1			Weight Data
2	1	400002	Scale Status
3			Scale Status

Unlike the other PLC interfaces that provide 2 words (4 bytes) of integer and division input data to the PLC, the ControlNet interface provides 4 words (8 bytes) of integer and division input data to the PLC. The first two words are reserved and the remaining two words match the format of the other interfaces as shown in Table A-2.

Table A-2: ControlNet PLC Input Data and Data Usage (Integer and Division)

PLC Input Bytes	PLC Input Words	Usage
0	0	Reserved
1		Reserved
2	1	Reserved

PLC Input Bytes	PLC Input Words	Usage
3		Reserved
4	2	Weight Data
5		Weight Data
6	3	Scale Status
7		Scale Status

The first output word (Word 0) is used to send certain data to the terminal. The second output word (word 1) is used to send certain commands to the terminal. Table A-3 shows the output usage information for the Integer and Divisions modes. The Modbus TCP interfaces register addresses are listed as a reference for that interface.

Table A-3: PLC Output Words and Word Usage (Integer and Division)

PLC Output Bytes	PLC Output Words	Modbus Address	Usage
0	0	401025	Weight Data
1			Weight Data
2	1	401026	Scale Commands
3			Scale Commands

Floating Point

For the PLC input, the first word (Word 0) of the floating point format is used for the command response. Words 1 and 2 provide 32-bits of input data and Word 3 includes the scale status bits. Table A-4 lists input usage information for the Floating Point mode. The Modbus TCP interfaces register addresses are listed as a reference for that interface.

Table A-4: PLC Floating Point Input Words

PLC Input Bytes	PLC Input Words	Modbus Register	Usage
0	0	400001	Reserved
1			Command Response
2	1	400002	Floating Point data
3			Floating Point data
4	2	400003	Floating Point data
5			Floating Point data
6	3	400004	Scale Status, Refer to Message Block Table
7			Scale Status, Refer to Message Block Table

Unlike the other PLC interfaces that provide 4 words (8 bytes) of floating point input data to the PLC, the ControlNet interface provides 6 words (12 bytes) of floating point input data to the PLC. The first two words are reserved and the remaining four words match the format of the other interfaces as shown in Table A-5.

Table A-5: ControlNet PLC Floating Point Input Words

PLC Input Bytes	PLC Input Words	Usage
0	0	Reserved
1		Reserved
2	1	Reserved
3		Reserved
4	2	Reserved
5		Command Response, refer to Message Block Table
6	3	Floating Point data
7		Floating Point data
8	4	Floating Point data
9		Floating Point data
10	5	Scale Status, See Message Block Table
11		Scale Status, See Message Block Table

For the PLC floating point output, the first word (Word 0) is reserved and not used. Word 1 is used for the command back to the terminal and Words 2 and 3 provide 32-bits of data. Table A-6 lists output usage information for the Floating Point mode. The Modbus TCP interfaces register addresses are listed as a reference for that interface.

Table A-6: PLC Floating Point Output Words

PLC Output Bytes	PLC Output Words	Modbus Register	Usage
0	0	401025	Reserved
1			Reserved
2	1	401026	Command
3			Command
4	2	401027	Floating Point data
5			Floating Point data
6	3	401028	Floating Point data
7			Floating Point data

Register Mapping – Modbus TCP Only

The memory of the Modbus TCP option board is mapped as shown previously in Table A-1, Table A-3, Table A-4 and Table A-6. The read and write areas of memory are offset by 1024. In a Quantum PLC, the PLC would read data from the IND131-331 starting at 400001 and would write data to the IND131-331 starting at register 401025. The reference is PLC processor memory-dependent. Other types of PLCs may use 4, 5 or 6 digits for register addresses. Refer to PLC documentation for I/O mapping information.

Assembly Instances of Class 1 Cyclic Communications – EtherNet / IP Only

Class 1 cyclic communications is used for transfer of Discrete Data between the PLC and the IND131/IND331.

The PLC Input Assembly Instance is 100 (decimal). This instance is used for all Data Formats and data size requirements.

The PLC Output Assembly Instance is 150 (decimal). This instance is used for all Data Formats and data size requirements.

The IND131/IND331 uses data only. Configuration data is not used or required. Within the PLC EtherNet / IP Interface setup set the Configuration Instance to 1 and the data size to zero.

The EDS file provided on the Documentation CD has no Assembly Instance or data size limitations. The IND131/IND331 programming controls the Assembly Instance and data size limitations.

Byte Order

The order of the bytes in the data can be arranged differently by selections in setup. Depending upon the interface, the order can be selected as Historic, Byte Swap, Word Swap or Double Word Swap. Selecting the format that matches the format of the data that the PLC is expecting saves time in manipulating the data after it is received in the PLC. Refer to Table A-7 and Table A-8 for details of how the byte order selection affects where the data appears in the input communication.

Table A-7: Integer and Division Byte Order - Output

	Historic	Byte Swap	Word Swap	Double Word Swap
Word 0	0x05aa	0xaa05	0x05aa	0xaa05
Word 1	0x8110	0x1081	0x8110	0x1081

Table A-8: Floating Point Byte Order - Output

	Historic	Byte Swap	Word Swap	Double Word Swap
Word 0	0x2000	0x2000	0x2000	0x2000
Word 1	0x44b5	0xb544	0x4000	0x0040
Word 2	0x4000	0x0040	0x44b5	0xb544
Word 3	0xc130	0x30c1	0xc130	0x30c1

Word Swap takes the IEE 754 single-precision floating point format and swaps the two words in the 32-bit double word. This format is compatible with RSLogix 5000 processors.

Data Integrity

The IND131/IND331 has specific bits to allow the PLC to confirm that data was received without interrupt and the IND131/IND331 is not in an error condition. It is important to monitor these bits. Any PLC code should use them to confirm the integrity of the data received for the IND131/IND331. Refer to the data charts for specific information regarding the Data OK, Update in Progress, Data Integrity bits and their usage.

Format Details

Integer and Division

When either of these formats is selected, the IND131/IND331 will provide two 16-bit words for input data and two 16-bit words for output data. The PLC's input data will contain one 16-bit word for the scale's weight or rate information and one 16-bit word for bit encoded status information. The IND131/IND331 will send specific data to the PLC input data based on the request it receives from the PLC's output data. The PLC's output words consist of one 16-bit integer value, which may be used to download a tare or target, and one 16-bit word for bit encoded command information.

Table A-9 and Table A-10 provide detailed information on the integer and division data formats. Read data refers to the PLC's input data and write data refers to the PLC's output data.

Note that the x10 feature will not work in integer or division mode. The weight will go to zero and the data ok bit will go to zero. If this feature is required, floating point format must be used.

Table A-9: Discrete Read Integer or Division – IND131/IND331 >> PLC

Bit number	Word 0	Word 1
	Refer to ControlNet note, below, regarding Word structure	
0	See Note 1	Feed
1		Fast Feed
2		Tolerance OK
3		Not Used
4		Not Used
5		Comparator 3 ³
6		Comparator 2 ³
7		Comparator 1 ³

Bit number	Word 0	Word 1
	Refer to ControlNet note, below, regarding Word structure	
8		Not Used
9		Input 1 ⁴
10		Input 2 ⁴
11		Not Used
12		Motion ⁵
13		Net Mode ⁶
14		Update in Process ⁷
15		Data OK ²

- The input data for ControlNet is offset by two reserved words at the beginning as shown in Table A-2. This changes the words described above to Word 2 and Word 3. This also changes the Word references in the notes below.

Notes for Table A-9

- 1 Word 0 is a 16 bit, signed integer that may represent the terminal’s gross weight, net weight, displayed weight, tare weight, or rate. The **bits 0 to 2** in the PLC 2nd output word designate what data is being sent by the terminal.
- 2 Word 1 **bit 15**; The data ok bit is set to ‘1’ when the terminal operating conditions are normal. The bit is set to ‘0’ during power-up, during terminal setup, when the scale is over capacity or under zero, and when in the x10 display mode; additionally, the Word 0 integer value is set to ‘0’. The PLC should continuously monitor the data ok bit and the PLC data connection fault bit (refer to the PLC documentation) to determine the validity of the data in the PLC.
- 3 Word 1 Comparator bits indicate the state of the associated comparator logic; when the bit is set to ‘1’ the comparator state is ‘ON’; when the bit is set to ‘0’ the comparator state is ‘OFF’. The setup of each comparator will determine when the state is ‘ON’ or ‘OFF’.
4. Word 1 **bits 9 and 10**, indicate the state of the associated hardware input internal to the terminal; these are 0.1.1 and 0.1.2. When the input is ‘ON’ the associated bit is set to ‘1’.
- 5 Word 1 **bit 12**; The motion bit is set to ‘1’ when the scale is in motion (unstable).
- 6 Word 1 **bit 13**; The net mode bit is set to ‘1’ when scale is in the net mode (a tare has been taken).
- 7 Word 1 **bit 14** (update in process) is set to ‘1’ when the terminal is in process of updating the data to the PLC communications adapter. The PLC should ignore all data while this bit is set to ‘1’.

Table A-10: Discrete Write Integer or Division –PLC >> IND131/IND331

Bit number	Word 0	Word 1 [Scale Command]
0	See Note 1	Select 1 ²
1		Select 2 ²
2		Select 3 ²
3		Load Tare ³
4		Clear Tare ⁴
5		Tare ⁵
6		Print ⁶

Bit number	Word 0	Word 1 [Scale Command]
7		Zero ⁷
8		Start/Abort Target ⁸
9		Load Fine Feed Value ⁹
10		Load Spill Value ¹⁰
11		Not Used
12		Output 1 ¹¹
13		Output 2 ¹¹
14		Output 3 ¹¹
15		Load Target Value ¹²

Notes for Table A-10

- 1 Word 0 is a 16 bit, signed integer that represents a value to be downloaded to the terminal as the tare or target value to be used. When using the divisions format, the data set must be in the number of divisions, not an integer weight value. A value must be loaded in this word before setting the **bits 3 or 15** in Word 1.
- 2 The select bits change the data being sent from the terminal in Word 0. Use a decimal value in binary format within **bits 0, 1, and 2** to change the data reported by the terminal. '0' = gross weight, '1' = net weight, '2' = displayed weight, '3' = tare weight, '4' = target, '5' = rate, '6' or '7' = equals gross weight.
- 3 A transition from '0' to '1' will cause the value in Word 0 to be loaded into the tare register of the terminal and set the terminal into the net mode. Set this bit to '1' only **after** Word 0 has been loaded with the required value.
- 4 A transition from '0' to '1' will cause the terminal tare register to be set to '0' and the terminal will be set to the gross weight mode.
- 5 A transition from '0' to '1' will cause the weight on the scale to be used as the tare value and set the terminal to the net mode (equivalent to a tare command). The scale will not tare while motion is detected. If the scale has not tared within 3 seconds the command must be resent.
- 6 A transition from '0' to '1' will issue a print command.
- 7 A transition from '0' to '1' will cause the scale to re-zero, but only within the ranges established in scale setup.
- 8 A transition from '0' to '1' will cause the target logic to start. A transition from '1' to '0' will cause the target logic to abort. The use of the PLC and the terminal console keypad and/or a remote input is not advised, as unexpected results may occur.
- 9 A transition from '0' to '1' will cause the value in Word 0 to be loaded into the fine feed value register of the terminal and will be used the next time the target logic is started. Set this bit to '1' only **after** Word 0 has been loaded with the required value.
- 10 A transition from '0' to '1' will cause the value in word 0 to be loaded into the spill value register of the terminal and will be used the next time the target logic is started. Set this bit to '1' only **after** Word 0 has been loaded with the required value.
- 11 The output bits will cause the associated hardware output to be turned 'ON' and 'OFF'. This is the terminal internal outputs only; 0.1.1, 0.1.2 and 0.1.3. The output bits will not override the hardware outputs being used by the terminal logic as setup within the terminal. Setting a bit to '1' will cause the output to turn 'ON'; setting the bit to '0' will cause the output to turn 'OFF'.
- 12 A transition from '0' to '1' will cause the value in Word 0 to be loaded into the target register of the terminal and will be used the next time the target logic is started. Set this bit to '1' only **after** Word 0 has been loaded with the required value.

Floating Point

Operational Overview

The IND131/IND331 accepts commands from the PLC to select the floating point output data. The IND131/IND331 recognizes a command when it sees a new value in the command word. If the command has an associated floating point value (for example: loading a target value), it must be loaded into the floating point value words before the command is issued. Once the IND131/IND331 recognizes a command, it acknowledges the command by setting a new value in the command acknowledge bits of the scale's command response word. The IND131/IND331 also tells the PLC what floating point value is being sent (via the floating point input indicator bits of the command response word). After sending a command, the PLC should wait until it receives the command acknowledgment from the IND131/IND331 before sending another command.

The IND131/IND331 has two types of values that it can report to the PLC: real-time and static. When the PLC requests a real-time value, the IND131/IND331 acknowledges the command from the PLC once but sends and updates the value repeatedly. If the PLC requests a static value, the IND131/IND331 acknowledges the command from the PLC once and updates the value once. The IND131/IND331 will continue to send this value until it receives a new command from the PLC. Gross weight and net weight are examples of real-time data. Tare weight, target value, fine feed value, and tolerance values are examples of static data.

The IND131/IND331 can send a rotation of up to seven different real-time values. The PLC sends commands to the IND131/IND331 to add a value to the rotation. Once the rotation is established, the PLC must instruct the IND131/IND331 to begin its rotation automatically, or the PLC may control the pace of rotation by instructing the IND131/IND331 to advance to the next value. If the IND131/IND331 is asked to automatically alternate its output data, it will switch to the next value in its rotation at approximately 25 Hz or 40 milliseconds.

The PLC may control the rotation by sending alternate report next field commands (commands 1 and 2). When the PLC changes to the next command, the IND131/IND331 switches to the next value in the rotation. The IND131/IND331 stores the rotation so the rotation does not have to be re-initialized after each power cycle. When the PLC does not set up an input rotation, the default input rotation consists of gross weight only. Refer to the floating-point command rotation examples (Table A-18 and Table A-19) for additional information. The method of handling floating point data varies between PLC generations. The IND131/IND331 provides floating point data in selectable formats to match the order used by most PLCs.

Table A-11 through Table A-14 provide detailed information on the floating-point data format. Read data refers to the PLC's input data and write data refers to the PLC's output data.

Table A-11: Discrete Read Floating Point – IND131/IND331 >> PLC Input

Bit number	Word 0 Command Response	Word 1 FP value	Word 2 FP value	Word 3 Scale Status
	See ControlNet note below regarding Word structure.			
0	RESERVED	See Note 4	See Note 4	Feed
1				Comparator 1 ⁶
2				Fast Feed
3				Comparator 2 ⁶
4				Tolerance OK
5				Comparator 3 ⁶
6				Not Used
7				Not Used
8	FP Input Indicator 1 ¹	See Note 4	See Note 4	Not Used
9	FP Input Indicator 2 ¹			Input 1 ⁷
10	FP Input Indicator 3 ¹			Input 2 ⁷
11	FP Input Indicator 4 ¹			Not Used
12	FP Input Indicator 5 ¹			Motion ⁸
13	Data integrity1 ²			Net Mode ⁹
14	Cmd Ack 1 ³			Data Integrity 2 ²
15	Cmd Ack 2 ³			Data OK ⁵

- The floating point input data for ControlNet is offset by two reserved words at the beginning as shown in Table A-5. This changes the words described above to Word 2, Word 3, Word 4 and Word 5. This also changes the Word references in the notes below.

Notes for Table A-11

- 1 The Floating Point Indicator bits (Word 0 bits 8-12) are used to determine what type of floating or other data is being sent in Words 1 and 2. See the Floating Point Indicator Table A-12 for the information from these bits in decimal format.
- 2 The Data Integrity bits (Word 0 bit 13 and Word 3 bit 14) should be used to assure that communication is still valid and that data are valid. Both of these bits are set to '1' for one update from the terminal, then are set to '0' for the next update from the terminal and this change of state is on every update and is constant as long as the communications link is not disrupted.
- 3 Word 0 Command Response bits (bits 14 and 15) are used by the terminal to inform the PLC that a new command was received. The decimal values of these bits will rotate sequentially from 1 to 3 as long as a command other than '0' is being sent (output Word 2). The decimal value of these bits will be '0' when output Word 2 (PLC output command word) is decimal '0'.
- 4 Words 1 and 2 are 32 bit, single precision floating point data. The data may represent the various scale weight data or setup configuration data. The PLC output command word determines what data will be sent.
- 5 Word 3 bit 15; The data ok bit is set to '1' when the terminal operating conditions are normal. The bit is set to '0' during power-up, during terminal setup, when the scale is over capacity or under zero, and when in the x10 display mode. The PLC should continuously monitor the data ok bit and the PLC data connection fault bit (see PLC documentation) to determine the validity of the data in the PLC.
- 6 Word 3 Comparator bits indicate the state of the associated comparator logic; when the bit is set to '1' the comparator state is 'ON'; when it is set to '0' the comparator state is 'OFF'. The setup on each comparator will determine when the state is 'ON' or 'OFF'.

- 7 Word 3 **bits 9 and 10**, indicate the state of the associated hardware input internal to the terminal; these are Input 1 and Input 2. When the input is 'ON' the associated bit is set to '1'.
- 8 Word 3 **bit 12**; The motion bit is set to '1' when the scale is in motion (unstable).
- 9 Word 3 **bit 13**; The net mode bit is set to '1' when scale is in the net mode (a tare has been taken). If no tare has been taken (gross mode), the bit is set to '0'.

Table A-12: Floating Point Input Indication

Dec	Hex	Data	Dec	Hex	Data
0	0	Gross Weight *	16	10	- Tolerance value **
1	1	Net Weight *	17	11	Reserved
2	2	Tare Weight *	18	12	Primary units
3	3	Fine Gross Weight *	19	13	Spill Value**
4	4	Fine Net Weight *	20	14	Calibration Status
5	5	Fine Tare Weight *	21	15	Reserved
6	6	Rate*	22	16	Reserved
7	7	Reserved	23	17	Reserved
8	8	Reserved	24	18	Reserved
9	9	Reserved	25	19	Reserved
10	A	Reserved	26	1A	Reserved
11	B	Low-pass filter frequency	27	1B	Reserved
12	C	Notch filter frequency	28	1C	Reserved
13	D	Target value**	29	1D	Last terminal error code
14	E	+ Tolerance value **	30	1E	Valid command
15	F	Fine feed value**	31	1F	Invalid command

Notes for Table A-12

- * Data is refreshed on every terminal update
- ** Value that is in the Target registers, may not be the active Target value

Table A-13: Discrete Write Floating Point – PLC >> IND131/IND331

Bit Number	Word 0	Word 1 [PLC Output Scale Command]	Word 2	Word 3
0	Reserved Do Not Use	Refer to Note 1 and Table A-14	Refer to Note 2	
1				
2				
3				
4				
5				
6				
7				
8				
9				
10				
11				
12				
13				
14				
15				

Notes for Table A-13

- 1 Word 1 is a 16 bit integer and is used to send commands to the terminal. The commands are used in conjunction with the floating point words but not all commands will require a value in the floating point load value words. Refer to Table A-14 for a list of the possible commands and their respective decimal and hex values.
- 2 Words 2 and 3 are to be a 32 bit single precision floating point value that will be used for downloading a tare, target or other value to the terminal as indicated in the Word 1 command.

Table A-14: PLC Output Command Table (Floating Point Only)

Dec	Command	Dec	Command	Dec	Command
0	Report next rotation field @ next update ¹	45	Add fine tare weight to rotation ⁷	136	Set Comparator 3 limit value ^{6,11}
1	Report next rotation field ^{2,3}	46	Add rate to rotation ⁷	137	Set Comparator 3 high limit value ^{6,11}
2	Report next rotation field ^{2,3}	60	Load programmable tare value ⁶	160	Apply scale setup (reinitialize) ^{7,9}
3	Reset (cancel) rotation	61	Pushbutton tare command ⁷	164	Disable Pushbutton Tare ⁷
10	Report gross weight ²	62	Clear command ⁷	165	Enable Pushbutton Tare ⁷
11	Report net weight ²	63	Print command ⁷	200	Calibrate Zero Reference Trigger ⁷
12	Report tare weight ²	64	Zero command ⁷	201	Calibrate Span # 1 Trigger -Use floating point value as test weight #1
13	Report fine gross weight ²	73	Set low-pass filter frequency ^{6,8}	202	Calibrate Span # 2 Trigger-Use floating point value as test weight #2
14	Report fine net weight ²	74	Set stability filter frequency ^{6,9}	203	Calibration Status ^{4,5}
15	Report fine tare weight ²	90	Set discrete output 1 "ON" ⁷	204	Set Calibration Test #1 ⁶
16	Report Rate ²	91	Set discrete output 2 "ON" ⁷	205	Set Calibration Test #2 ⁶
19	Report low-pass filter frequency ^{5,8}	92	Set discrete output 3 "ON" ⁷	206	Report Calibration Test #1 ^{4,5}
20	Report stability filter frequency ^{5,9}	93	Set discrete output 4 "ON" ⁷	207	Report Calibration Test #2 ^{4,5}
21	Report target value ⁵	100	Set discrete output 1 "OFF" ⁷	210	Set Comparator 1 limit value ^{6,12}
22	Report (+) tolerance value ⁵	101	Set discrete output 2 "OFF" ⁷	211	Set Comparator 1 high limit value ^{6,12}
23	Report fine feed value ⁵	102	Set discrete output 3 "OFF" ⁷	212	Set Comparator 2 limit value ^{6,12}
24	Report (-) tolerance value ⁵	103	Set discrete output 4 "OFF" ⁷	213	Set Comparator 2 high limit value ^{6,12}
26	Report Spill Value ⁵	110	Set target value ⁶	214	Set Comparator 3 limit value ^{6,12}
27	Report comparator 1 limit value ⁵	111	Set target fine feed value ⁶	215	Set Comparator 3 high limit value ^{6,12}
28	Report comparator 1 high limit value ⁵	112	Set (-) tolerance value ⁶	220	Disable Keypad
29	Report comparator 2 limit value ⁵	114	Start target logic ⁷	221	Enable Keypad
30	Report comparator 2 high limit value ⁵	115	Abort target logic ⁷	222	1 Limit ^{5,13}
31	Report units ^{5,10}	121	Enable target latching ⁷	223	1 High Limit ^{5,13}
32	Report comparator 3 limit value ⁵	122	Disable target latching ⁷	224	2 Limit ^{5,13}
33	Report comparator 3 high limit value ⁵	124	Set Target Spill Value ⁶	225	2 High Limit ^{5,13}
40	Add gross weight to rotation ⁷	131	Set (+) tolerance value ⁶	226	3 Limit ^{5,13}
41	Add net weight to rotation ⁷	132	Set Comparator 1 limit value ^{6,11}	227	3 High Limit ^{5,13}
42	Add tare weight to rotation ⁷	133	Set Comparator 1 high limit value ^{6,11}	232	Apply new limits ¹³
43	Add fine gross weight to rotation ⁷	134	Set Comparator 2 limit value ^{6,11}		
44	Add fine net weight to rotation ⁷	135	Set Comparator 2 high limit value ^{6,11}		

Notes for Table A-14

- 1 Rotation is setup by commands 40 to 48. On each terminal update the next field of the rotation setup is reported in Words 1 and 2 of the floating point output from the terminal. The floating point indication date reports what the field data represents. To keep up with the rotation changes, the PLC program scan time should be 30 milliseconds or less. A command of '0' without rotation setup will report the scale gross weight. The commands acknowledge bits are set to the value of '0'.
- 2 A command that requests data that is refreshed on every terminal update.
- 3 Toggling between commands 1 and 2 will allow the PLC to control the rotation field change.
- 4 Calibration Status: 0 = OK, 1 = adjustment in progress, 10 – adjust in dynamic, 255 = adjustment failure
- 5 A command that request a specific value; as long as the request is in the command word to the terminal no other data will be reported by the terminal.
- 6 A command that requires a floating point value be in Words 1 and 2 when the command is sent to the terminal. If the command is successful the returned floating point value will equal the value sent to the terminal.
- 7 A command that will not report back a value; the floating point data from the terminal will be zero.
- 8 0 = Light, 1 = Medium, 2 = Heavy
- 9 0 = Disable, 1 = Enabled
- 10 0 = None, 1 = g, 2 = kg, 3 = lb, 4 = t, 5 = ton
- 11 Floating point commands 132 – 137 for loading comparator limits were used in Version 1.xx firmware. They are not used in Version 2.xx firmware.
- 12 Floating point commands 210 – 215 for loading comparator limits are used in Version 2.xx firmware. They were not used in Version 1.xx firmware.
- 13 Floating point commands 222-232 for reporting and applying new comparator limits are used in Version 2.05 firmware or later. They are not used in earlier firmware versions.

Floating Point Data Integrity and Compatibility

In Floating Point Message mode, the PLC and terminal exchange weight, target, and tare data in single-precision floating-point format. The IEEE Standard for Binary Floating-Point Arithmetic, ANSI/IEEE Standard 754-1985, specifies the format for single-precision floating point numbers. It is a 32-bit number that has a 1-bit sign, an 8-bit signed exponent, and a 23-bit mantissa. The 8-bit signed exponent provides scaling of weight data. The 23-bit mantissa allows representation of 8 million unique counts.

Although the single-precision floating point number provides greater numerical precision and flexibility than integer weight representations, it has limitations. The weight representation may not be exact, particularly for the extended-resolution weight fields for high-precision bases.

There are two data integrity bits that the terminal uses to maintain data integrity when communicating with the PLC. One bit is in the beginning byte of the data; the second is in the ending byte of the data. The PLC program must verify that both

data integrity bits have the same polarity for the data to be valid. There is a possibility that the PLC program will see several consecutive invalid reads when the terminal is freely sending weigh updates to the PLC. If the PLC detects this condition, it should send a new command to the terminal.

Allen-Bradley PLC Floating Point Notes

The method of handling string and floating point data varies between Allen-Bradley PLC generations. The IND131/IND331 provides floating point data in selectable data formats to match the order used by the PLC.

Some Allen-Bradley PLCs require special integrity checking to communicate floating point numbers across the Remote I/O link. The Allen-Bradley PLC-5 and KTX Scanner Card programs must check two data integrity bits to verify the integrity of the floating point data it reads from the terminal. Allen-Bradley SLC programs always read valid floating-point data from the terminal and do not have to make special checks to guarantee the validity of the floating-point data. The Allen-Bradley PLC-3 and PLC-5/250 cannot support terminals in floating point mode as they cannot guarantee the integrity of the floating-point data.

PROFIBUS PLC Floating Point Notes

The Simatic T1505 PLCs support the IEEE Standard floating point numbers. According the Simatic T1505 Programming Reference Manual real numbers are stored in the single-precision 32-bit format, according to ANSI/IEEE Standard 754-1985, in the range 5.42101070 E-20 to 9.22337177 E18.

Siemens S5 PLCs do not support inherently the IEEE-format floating point numbers. S5 PLCs do support floating point numbers in their own unique format. You can implement a software "function block" in the S5 PLC that converts between the S5 floating point numbers and the IEEE Standard floating point numbers.

The Siemens S7 PLCs support the IEEE Standard floating point numbers.

Floating Point Command Examples

Table A-15 through Table A-19 provide floating point command examples.

Table A-15: Data Requirement: Only Net Weight Sent (continuously)

Step #	Scale Command (From PLC)	Scale Floating Point Value	Command Response From Terminal	Floating Point Value
1 (PLC sends command to IND131/IND331 terminal to report net weight)	11 (dec) loaded into command word	none required		
2 (IND131/IND331 terminal sees new command)			Command ack. = 1 F.P. ind. = 1 (net)	Net weight in floating point

As long as the PLC leaves the 11 (dec) in the command word, the IND131/IND331 terminal will update the net value every interface update cycle. The Command Acknowledge bits are used by the terminal to inform the PLC that a new command was received. The decimal values of these bits will rotate sequentially from 1 to 3 as long as a command other than '0' is being sent. The decimal value of these bits will be '0' when the command word is decimal '0'. The example assumes that the Command acknowledge value has started at three.

Table A-16: Data Requirement: Load Target Value = 21.75

Step #	Scale command (from PLC)	Scale Floating Point Value	Command response from terminal	Floating Point Value
1 (PLC loads floating point value first)		floating point value = 21.75		
2 (PLC sends command to set target 1 cutoff value)	110 (dec) loaded into command word	floating point value = 21.75		
3 (IND131/IND331 terminal sees new command, loads the value into the target and sends a return message to indicate the new target value)			Command ack. = 1 F.P. ind = 13	Floating point value = 21.75
4 (PLC instructs IND131/IND331 terminal to start "using" new target value)	114 (dec) loaded into command word			
5 (IND131/IND331 terminal sees new command)			Command ack. = 2 F.P. ind = 30	0.0

Step #	Scale command (from PLC)	Scale Floating Point Value	Command response from terminal	Floating Point Value
<p>The PLC should always wait to receive a command acknowledgment before sending the next command to the IND131/IND331 terminal. After the PLC finishes loading its target value, it can resume monitoring the weight information required by sending a command to report some type of weight or set up a rotation of reported data. The Command Acknowledge bits are used by the terminal to inform the PLC that a new command was received. The decimal values of these bits will rotate sequentially from 1 to 3 as long as a command other than '0' is being sent. The decimal value of these bits will be '0' when the command word is decimal '0'. The example assumes that the Command acknowledge value has started at three.</p>				

Table A-17: Data Requirement: Load Comparator Limit Value = 15.75

Step #	Scale command (from PLC)	Scale Floating Point Value	Command response from terminal	Floating Point Value
1 (PLC loads floating point value first)		floating point value = 15.75		
2 (PLC sends command to set Comparator 1 Limit value)	210 (dec) loaded into command word	floating point value = 15.75		
3 (IND131/IND331 terminal sees new command, loads the value into the Comparator 1 and sends a return message to indicate the new Limit 1 value)			Command ack. = 1 F.P. ind = 30	Floating point value = 15.75
4 (PLC instructs IND131/IND331 terminal to start "using" new Comparator value)	232 (dec) loaded into command word			
5 (IND131/IND331 terminal sees new command)			Command ack. = 2 F.P. ind = 30	0.0
<p>The PLC should always wait to receive a command acknowledgment before sending the next command to the IND131/IND331 terminal. After the PLC finishes loading its Comparator value, it can resume monitoring the weight information required by sending a command to report some type of weight or set up a rotation of reported data. The Command Acknowledge bits are used by the terminal to inform the PLC that a new command was received. The decimal values of these bits will rotate sequentially from 1 to 3 as long as a command other than '0' is being sent. The decimal value of these bits will be '0' when the command word is decimal '0'. The example assumes that the Command acknowledge value has started at three.</p>				

**Table A-18: Data Requirement: Rotation of Gross Weight and Rate
Updated on Interface Update Cycle**

Step #	Scale Command (from PLC)	Scale Floating Point Value	Command Response from Terminal	Floating Point Value
1 (PLC clears out any previous rotation with reset)	3 loaded into command word			
2 (IND131/IND331 terminal sees new command)			Command ack. = 1 F.P. ind = 30	0.0
3 (PLC adds gross weight to rotation)	40 (dec) loaded into command word	(null value)		
4 (IND131/IND331 terminal sees new command)			Command ack. = 2 F.P. ind = 30	0.0
5 (PLC adds rate to the rotation)	46 (dec) loaded into command word			
6 (IND131/IND331 terminal sees new command)			Command ack. = 3 F.P. ind = 30	0.0
At this point, the rotation has been set up. Now the PLC needs to command the IND131/IND331 terminal to begin the rotation.				
7 (PLC sends the command to begin the rotation at interface update cycle)	0 loaded into command word			
8 (IND131/IND331 terminal sends gross weight at interface update cycle ~ 60 msec)			Command ack. = 0 F.P. ind = 0	Floating point value = gross wt.
9 (PLC leaves 0 in its command word and the IND131/IND331 terminal sends the rate value at the next interface update cycle)	0 loaded into command word	RESERVED for Future Use	Command ack. = 0 F.P. ind = 6	Floating point value = rate
10 (PLC leaves 0 in its command word and IND131/IND331 terminal sends the gross value at next interface update cycle)	0 loaded into command word		Command ack. = 0 F.P. ind = 0	Floating point value = gross wt.
11 (PLC leaves 0 in command word and IND131/IND331 terminal sends the rate value at the next interface update cycle)	0 loaded into command word	RESERVED for Future Use	Command ack. = 0 F.P. ind = 6	Floating point value = rate

Step #	Scale Command (from PLC)	Scale Floating Point Value	Command Response from Terminal	Floating Point Value
<p>This rotation continues until the PLC sends a different command. At approximately every 50 msec the IND131/IND331 terminal updates its data with the next field in its rotation. The PLC must check the floating point indication bits to determine which data is in the floating point value. The Command Acknowledge bits are used by the terminal to inform the PLC that a new command was received. The decimal values of these bits will rotate sequentially from 1 to 3 as long as a command other than '0' is being sent. The decimal value of these bits will be '0' when the command word is decimal '0'. The example assumes that the Command acknowledge value has started at three.</p>				

Table A-19: Data Requirement: Rotation of Net Weight and Rate Updated on PLC Command

Step #	Scale command (from PLC)	Scale Floating Point Value	Command response from terminal	Floating Point Value
1 (PLC clears out any previous rotation with reset)	3 loaded into command word			
2 (IND131/IND331 terminal sees new command)			Command ack.= 1 F.P. ind = 30	0.0
3 (PLC adds net weight to rotation)	41 (dec) loaded into command word	(null value)		
4 (IND131/IND331 terminal sees new command)			Command ack. = 2 F.P. ind = 30	0.0
5 (PLC adds rate to the rotation)	46 (dec) loaded into command word	RESERVED for Future Use		
6 (IND131/IND331 terminal sees new command)			Command ack. = 3 F.P. ind = 30	0.0
<p>At this point, the rotation has been set up. Now the PLC needs to send commands to the IND131/IND331 terminal to begin the rotation and advance to the next value when required.</p>				
7 (PLC sends the command to report the first field in the rotation.)	1 loaded into command word			
8 (IND131/IND331 terminal acknowledges the command and sends net weight at every interface update cycle until the PLC gives the command to report the next rotation field.)			Command ack. = 1 F.P. ind = 1	Floating point value = net weight
9 (PLC sends the command to report the next field.) Note: if the PLC leaves the 1 in the command, the IND131/IND331 terminal does NOT see this as another command to report the next rotation field.	2 loaded into command word			

Step #	Scale command (from PLC)	Scale Floating Point Value	Command response from terminal	Floating Point Value
10 (IND131/IND331 terminal acknowledges the command and sends rate at every interface update cycle until the PLC gives the command to report the next rotation field.)		RESERVED for Future Use	Command ack. = 2 F.P. ind = 6	Floating point value = rate
11 (PLC sends the command to report the next field in the rotation.)	1 loaded into command word			
12 (IND131/IND331 terminal acknowledges the command and sends net weight at every interface update cycle until the PLC gives the command to report the next rotation field.)			Command ack. = 1 F.P. ind = 1	Floating point value = net wt.
13 (PLC sends the command to report the next field.)	2 loaded into command word			
14 (IND131/IND331 terminal acknowledges the command and sends rate at every interface update cycle until the PLC gives the command to report the next rotation field.)		RESERVED for Future Use	Command ack. = 2 F.P. ind = 6	Floating point value = rate
<p>At approximately every 50 msec the IND131/IND331 terminal updates its data with new data, but it does not advance to the next field in the rotation until the PLC sends it the command to report the next field. The PLC should check the floating point indication bits to determine which data is in the floating point value. The Command Acknowledge bits are used by the terminal to inform the PLC that a new command was received. The decimal values of these bits will rotate sequentially from 1 to 3 as long as a command other than '0' is being sent. The decimal value of these bits will be '0' when the command word is decimal '0'. The example assumes that the Command acknowledge value has started at three.</p>				

Floating Point PLC Calibration Example

The IND131/IND331 terminal supports calibration using commands from the PLC. Table A-20 lists the floating point commands used, with a brief description of what each command does.

Table A-20: PLC Calibration Commands

Command	Description
200	Calibrate zero reference trigger
201	Calibrate span #1 trigger. Use floating point value as test weight #1
202	Calibrate span #2 trigger. Use floating point value as test weight #2 (used when linearity is enabled).

Command	Description
203	Calibration status 0 – adjustment OK 1 – adjustment in progress (countdown) 10 – adjust in dynamic mode (motion on scale) 255 – adjustment failure
204	Set calibration Test #1 (used for span #1)
205	Set calibration Test #2 (used for span #2)
206	Report calibration Test #1 (used for span #1)
207	Report calibration Test #2 (used for span #2)

Preparation for Calibration

When the PLC triggers calibration, the following bits will immediately be set:

Data OK will be turned OFF

All **comparators** will be turned OFF

Target will be aborted (OFF)

After calibration is complete, the Data OK bit will reset and the comparators will begin working. The target must be turned ON either manually, or by the PLC.

Calibration Procedures

Zeroing the Scale

1. Make sure scale is empty (zero reference point).
2. Send command 200 to trigger the zero capture function.
3. Monitor 203 for the progress and the final status of the zero.

Calibrating the Scale – Linearity Disabled

1. Load span test weight value via command 204.
2. Confirm correct test weight was received via command 206.
3. Add test weight to the scale.
4. Send command 201 to trigger the calibration of the span.
5. Monitor 203 for the progress and the final status of the calibration.

Calibrating the Scale – Linearity Enabled

1. Load the mid-point span test weight value via command 204.
2. Load the high-point span test weight value via command 205.
3. Confirm correct test weight values were received via commands 206 and 207.

4. Add mid-point test weight to the scale.
5. Send command 201 to trigger the calibration of the mid-point of span.
6. Monitor 203 for the countdown sequence and the final status of the calibration.
7. Add high-point test weight to the scale.
8. Send command 202 to trigger the calibration of the high-point of span.
9. Monitor 203 for the progress and the final status of the calibration.

Controlling the Discrete I/O Using a PLC Interface

The IND131/IND331 terminal provides the ability to directly control its discrete outputs and read its discrete inputs via the (digital) PLC interface options. System integrators should be aware that the terminal's discrete I/O updates are synchronized with the terminal's A/D rate and not with the PLC I/O scan rate. This may cause a noticeable delay in reading inputs or updating outputs as observed from the PLC to real world signals. Consult the **IND131/IND331 Installation Manual** for discrete I/O wiring. Also note the outputs must be unassigned in the IND131/IND331 terminal setup in order for the PLC to control them.

METTLER TOLEDO

1900 Polaris Parkway
Columbus, Ohio 43240

METTLER TOLEDO[®] is a registered
trademark of Mettler-Toledo, LLC
©2012 Mettler-Toledo, LLC

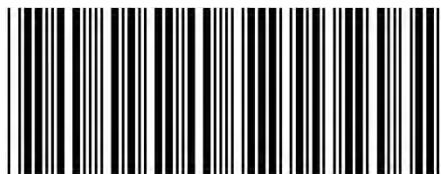

64067815