

PARAMOUNTS™

Weigh Module Kit

Installation Guide

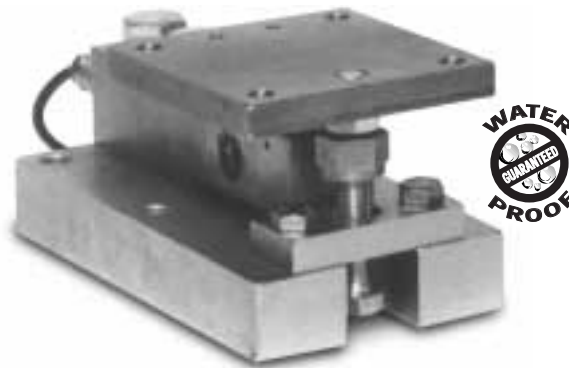

RICE LAKE WEIGHING SYSTEMS
Industrial Solutions on a Global Scale®



16953

Contents

1. Introduction	1
1.1 Overview	1
1.2 Lift Off Protection/Jacking Provision	1
1.3 Physical Dimension	2
1.4 Mount Configurations	2
1.5 Typical Application	3
2. Basic Rules for Positioning Load Cells	4
3. Support Surface Preparation	7
3.1 Installation on Concrete Foundations	7
3.2 Installation on Structural Steelwork	8
3.3 Stiffness Requirements	8
3.4 Level Requirements	8
3.5 "Upside Down" Requirements	8
4. Installation	9
4.1 General Guidelines	9
4.2 Detailed Installation Procedures	10
4.2.1 Installing Base Plates	10
4.2.2 Aligning Top Plates	11
4.2.3 Attaching the Vessel to Top Plates	11
4.2.4 Locking Mounts in Weighing Position	12
4.2.5 Load Cell Wiring.....	12
4.2.6 Trimming	12
4.2.7 Final Checks	12
4.2.8 Optional Installation Method	12
5. Maintenance	13
5.1 General	13
5.2 Load Cell Replacement	13
6. Replacement Parts.....	15
6.1 Fixed Pin Mount	15
6.2 Side Stop and Free Sliding Mounts	16
6.3 Load Cells	16
7. Limited Warranty	17

1. Introduction

1.1 Overview

Paramount™ kits are used for mounting SB-4 load cells to vessels, tanks, hoppers, platforms, roller tables, and similar applications. They are especially useful where thermal expansion/contraction of the weighing vessel is likely. Note that in this manual, the term “vessel” is used for convenience only; the term applies equally to any of the load-receiving devices listed above.

Each Paramount kit includes:

- One EL604ET junction box
- One fixed pin mount with SB-4 load cell
- One side stop mount with SB-4 load cell
- One (or more) free sliding mount(s) with SB-4 load cell(s)
- 25' of load cell cable

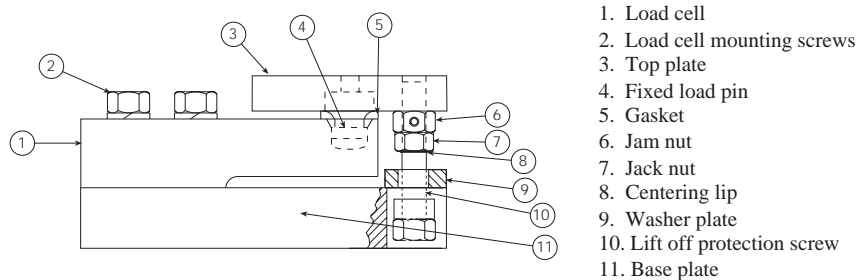

Figure 1

1.2 Lift Off Protection/Jacking Provision

Each of the three types of mounts incorporates a threaded lift off protection screw that passes through the top and bottom plates (see Figure 1). The screw is threaded into the top plate, but passes through an oversized hole in a washer plate secured to the base plate. This allows enough independent movement of the top and base plates for weighing, yet provides protection against accidental lift off. During installation, a jack nut with a centering lip can be screwed down to assist in aligning the top and bottom plates. This ensures that the lift off protection screw is centered in the hole through the washer plate. The same jack nut can be used to raise the top plate during maintenance operations such as load cell replacement. However, the jack nut should only be used to raise an empty vessel.

During weighing, this jack nut is locked in the upper position as shown in Figure 1 above.

1.3 Physical Dimension

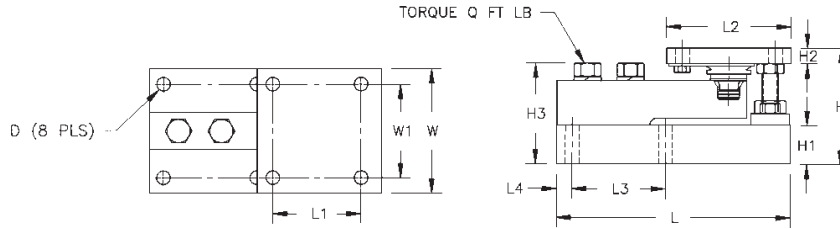

Rated Capacity	Dimensions - Inches														
	D	H	H1	*H2	**H2	H3	L	L1	L2	L3	L4	W	W1	Q (FT-LB)	
225lb (1KN) - 520lb (2.3KN)	.375	2.24	.62	.37	.62	2.09	6.23	2.12	3.00	2.12	.44	3.00	2.12	15	
1125lb (5KN) - 5200lb (23KN)	.437	3.58	1.25	.50	.75	3.06	7.51	3.00	4.00	3.00	.50	4.00	3.00	65	
11,250lb (50KN)	.562	4.66	1.50	1.00	.62	4.09	9.19	3.87	5.00	3.87	.56	5.00	3.87	295	
22,500lb (100KN)	.688	6.41	2.00	1.25	.75	5.73	11.46	4.75	6.00	4.75	.69	6.00	4.75	515	

*H2 is for Side Stop and Free Floating units. KN = Kilonewtons
 **H2 is for Fixed Pin units.

Figure 2

1.4 Mount Configurations

When installed according to the guidelines in this manual, the Paramount kit allows for thermal expansion/contraction of the weighing vessel, while keeping the vessel in check without the use of check rods in many applications. A clear understanding of the function of each of the three types of mounts is necessary in planning your installation.

- Fixed pin mount—eliminates all horizontal movement of the top plate except rotation around the loading pin.
- Free sliding mount—allows horizontal movement of the top plate in all directions.
- Side stop mount—allows horizontal movement of the top plate only along the axis of the load cell.

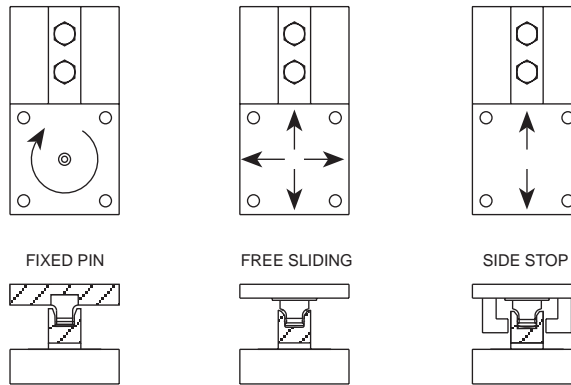

Figure 3

Free sliding and side stop mounts have loading pins with teflon coated top surfaces that slide on stainless steel plates attached to the underside of the top plates. This combination allows the top plates to move freely as indicated by the arrows.

1.5 Typical Application

The sample installations shown in Figure 4 demonstrate the basic principles involved with module applications. Arrows by each mount indicate the directions that the top plate for that mount can move. When arranged as illustrated, the position of the vessel is fixed at one point by the fixed pin mount. The side stop mount allows for thermal expansion/contraction in the direction of the arrows while checking movement in other directions. Free sliding mounts allow for expansion in all directions. This arrangement ensures that there is minimal binding or side loading of the load cells. At the same time, the system is self-checking.

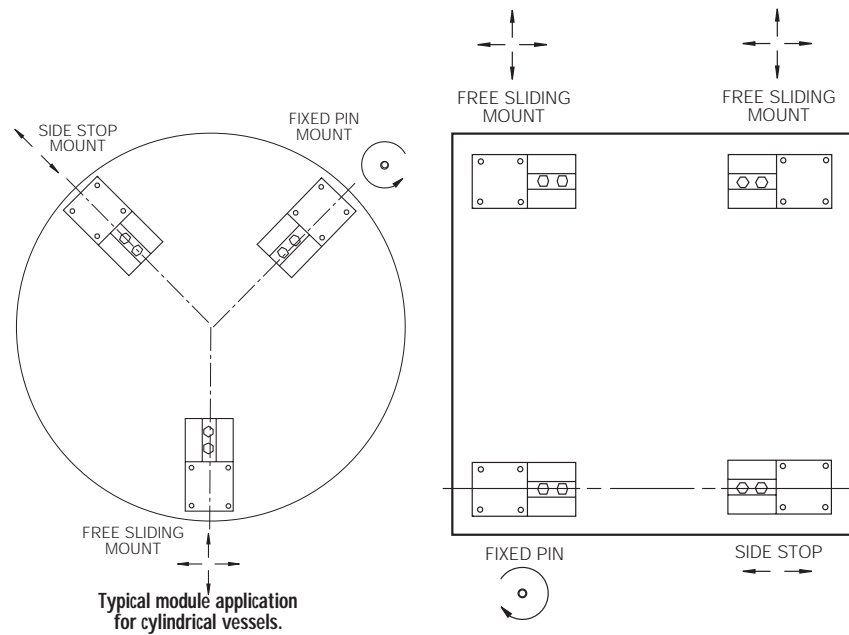

Figure 4

Caution

With tall, slender vessels or in areas with earthquake activity or high winds, safety may require additional vessel restraints in the form of stay rods or safety check rods.

2. Basic Rules for Positioning Load Cells

- Position load cells to distribute the load between the cells as evenly as possible. If an even load distribution is not possible because of the layout, higher capacity load cells may be necessary. This should not affect weighing accuracy. However, all load cells in a scale must be of the same capacity.
- Always use one fixed pin mount and one side stop mount; use free sliding mounts at all other support points.
- The longitudinal axis of the side stop mount should point generally toward the fixed pin unit. In most applications with four or more load cells, the side stop mount should be positioned such that its longitudinal axis points directly toward the fixed pin mount as in Figures 5B, 6, 7 and 8 on page 5. In applications with only three load cells, it may be difficult to position the side stop mount to align perfectly with the fixed pin mount. In those cases, the maximum permissible angle of deviation (∞) is 45°. Some typical installations with acceptable angles are shown in Figures 5A and 5C on page 5.
- If possible, the fixed pin mount should be positioned so that the longitudinal axis of the load cell points in the direction of any prevalent side force. For example, when under a roller table, the longitudinal axis of the load cell should point in the direction of travel. For a vessel subject to thermal cycling, the axis should be aligned in the direction of maximum expansion/contraction
- When installing load cells and tank mount assemblies directly under tank legs, avoid subjecting the structure to any unnecessary bending moments. To prevent unnecessary bending, observe the precaution in Figure 9 on page 6.
- To reduce cost, it is sometimes possible to replace one or more of the load cells with dummy load cell mounts. This may be done only in liquid weighing applications where the load distribution between mounts remains constant. Some accuracy will be sacrificed with this method.

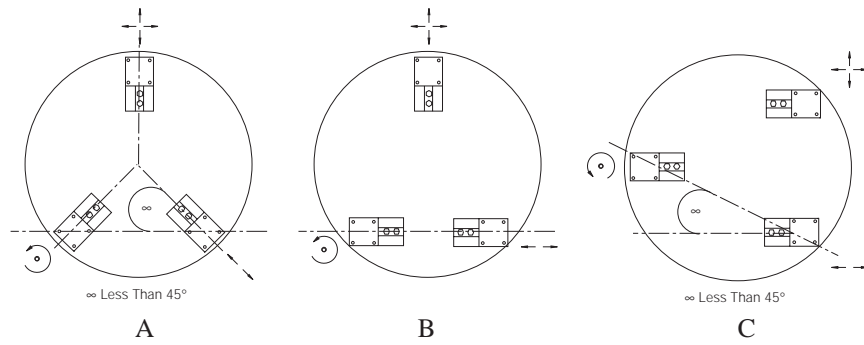

Figure 5. Three Load Cells on Round Vessel

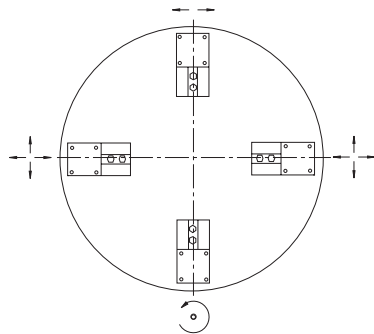

Figure 6. Four Load Cells on Round Vessel

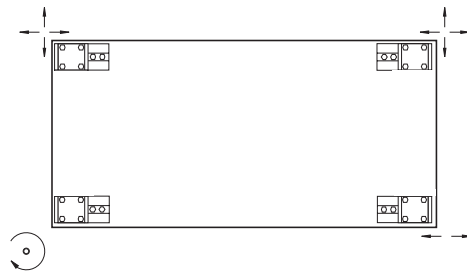

Figure 7. Four Load Cells on Rectangular Vessel

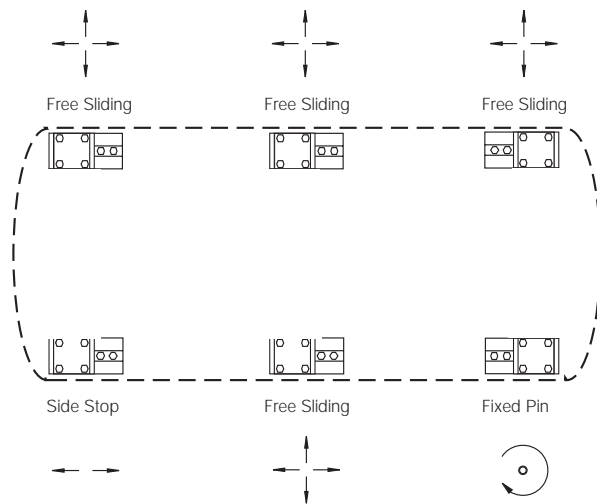
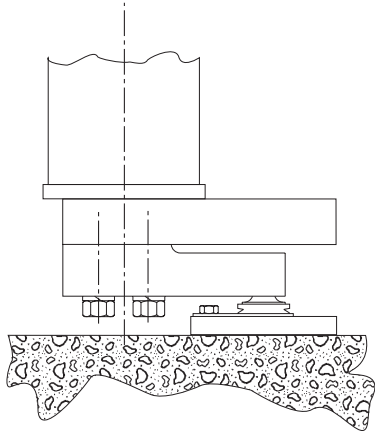
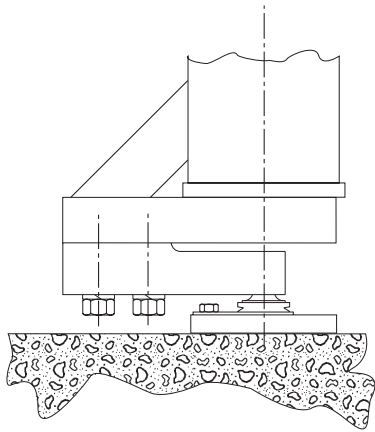

Figure 8. Six Load Cells on Rectangular Vessel



INCORRECT
Moment arm causes bending
moment on leg.



CORRECT

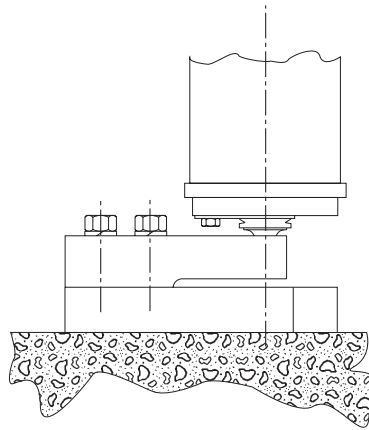

CORRECT

Figure 9

3. Support Surface Preparation

3.1 Installation on Concrete Foundations

A typical installation on a concrete foundation is shown in Figure 10 where a steel foundation plate has been grouted-in using threaded concrete anchor studs or expanding anchor studs. The Paramount base plate and top plate may then be bolted to the foundation plate and vessel or welded for a quick and simple installation that eliminates the need for matching bolt holes.

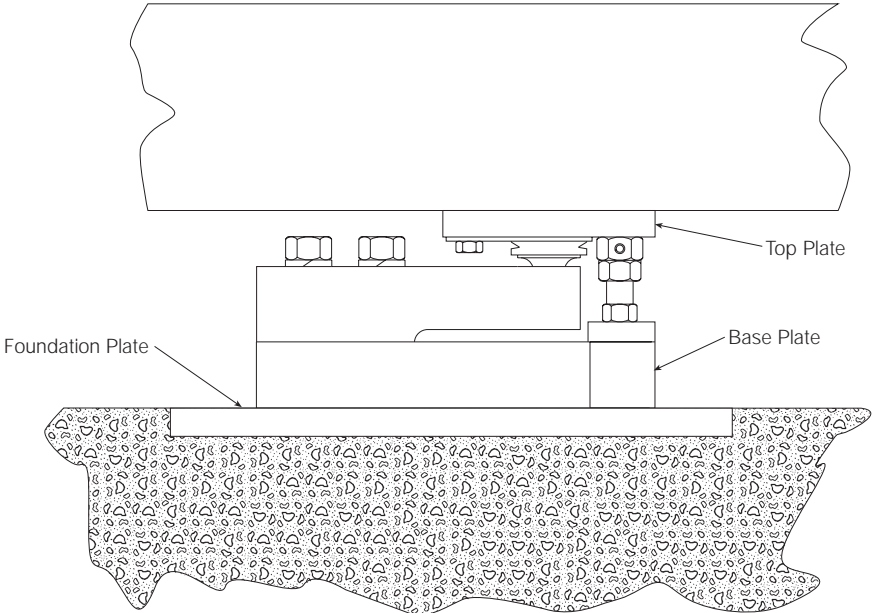

Figure 10

3.2 Installation on Structural Steelwork

Figure 11 shows an installation where the mount base plate is welded or bolted directly to a steel beam structure. The mount top plate is welded or bolted directly to the vessel. When large loads are applied, the supporting beams may need strengthening with stiffening plates to avoid excessive deflection.

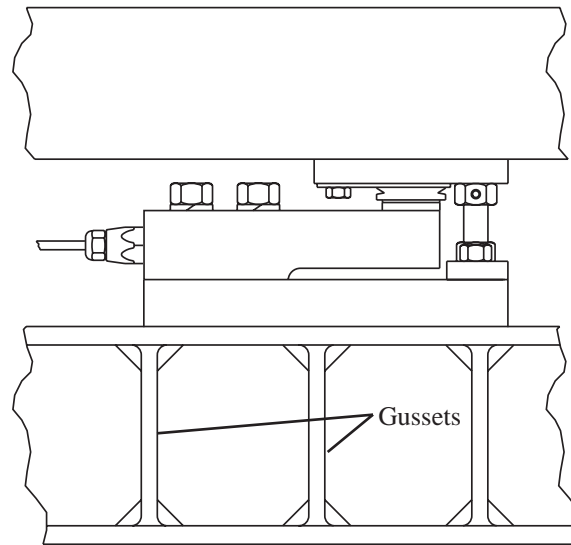

Figure 11

3.3 Stiffness Requirements

Load variations and external forces can cause support surface level variations. The maximum permissible change in the level of the support surface is 0.2° and 0.5° for base plate and top plate respectively in scales with greater than 0.1% accuracy. In all other scales, permissible change is 0.4° and 1.0° respectively.

3.4 Level Requirements

In scales with an accuracy of 0.1% or better, the support surface for the base plate must be level within 0.2 degrees (.4" per 100"). The vessel support surface for the top plate must be level within 0.5 degrees (9" per 100").

3.5 "Upside Down" Requirements

From a weighing point of view there is nothing to prevent installing the mounting kits upside down with the "base" plate on the vessel and the "top" plate on the foundation. By using this method, designs can sometimes be simplified and serviceability improved.

4. Installation

4.1 General Guidelines

The mounts are normally shipped from the factory fully assembled with the load cells fitted and the mounting screws torqued to the correct values. If the load cells are removed from the base plate for any reason, they should be reassembled using the procedure in Section 5.2 and the torque values listed in the following table.

Load Cell Capacity	Bolt	Torque (in FT-LBS)
1KN (225lb)	5/16-18	15
2.3KN (520lb)	5/16-18	15
5KN (1,125lb)	1/2-13	65
10KN (2,250lb)	1/2-13	65
23KN (5,200lb)	1/2-13	65
50KN (11,250lb)	3/4-10	295
100KN (22,500lb)	1-8	515

Note:

All bolts must be at least grade 5.

The mounts are also shipped with the jack nut tightened down so that the top plate is lifted clear of the load cell. This is done to protect the load cell in shipping. See Figure 12 below.

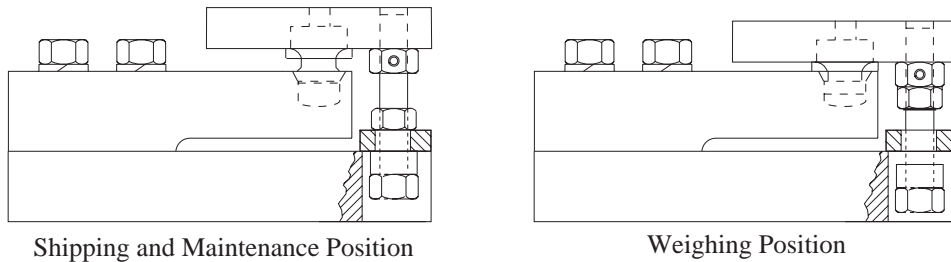

Figure 12

Each of the three types of Paramounts has identical base and top plate hole locations for a given capacity. The holes in the top plate are symmetrical around the loading point permitting rotation of the complete mount for the best line up with other tank mounts. This also optimizes accessibility to load cell mounting screws for load cell replacement. Figure 13 on the following page illustrates a preferred orientation to assure easy access to load cell mounting bolts.

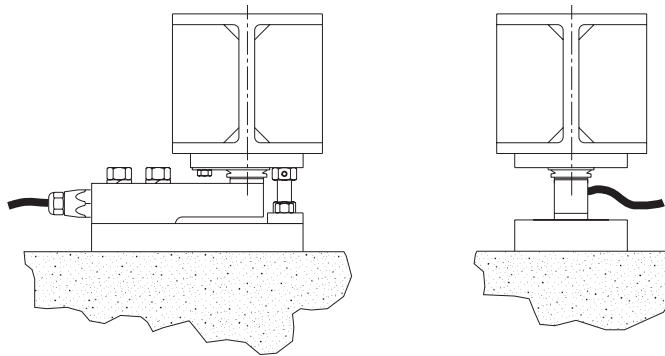

Figure 13

If the position of the vessel in relation to surrounding structures is critical, as in scales mounted in pits, the vessel must be placed in the correct position before welding or bolting the top plates and base plates. This installation is described in Section 4.2.8.

The top and base mounting plates may be bolted or welded to the vessel and the foundation. After welding or bolting, all base plates themselves are strong enough to take rated load without relying on additional stiffness provided by the support structure. Therefore, the welding only has to be strong enough to support anticipated side loads or lift-off loads.

4.2 Detailed Installation Procedures

4.2.1 Installing Base Plates

Remove all mounts from their packaging material and identify the three different types as discussed in Section 1.4. Position the fixed pin, side stop, and free sliding mounts on their support surfaces as discussed in Section 2. Check with a level on top of the base plate to insure that the plate is level within the limits specified in Section 3.4. If necessary, wedge shims under the base plate.

When satisfied that the plates are positioned correctly, press the base plate firmly against the foundation and tack weld. Check that the plate has not changed position, then make the final weld. Bolting rather than welding is also acceptable.

Caution

When welding plates with attached load cells, place the welding ground cable as close as possible to the welding location to prevent the welding current from passing through the load cell. Protect both the load cell and its cable from weld splatter using cover plates or shields. If possible, the load cell should be removed from the base plate during welding. Do not allow excessive heat to be conducted to the load cell, as this may damage the strain gauges. If necessary, weld in several passes, allowing time for the assembly to cool between passes.

The mild steel mounts are zinc plated with yellow chromate. Before welding these mounts, grind off the plating in the immediate area of the weld. After welding is complete, wirebrush all welds and degrease. Paint with primer and top coat to match surrounding steelwork.

 **Caution**

The stainless steel slide plates on the underside of the top plates must NOT be painted.

4.2.2 Aligning Top Plates

 **Caution**

Do not place the vessel on the top plates while the Paramounts are in the “shipping” position (top plates raised up by the jacking nut). The lift off protection screw may be bent if weight is placed on the mount before the vessel is securely attached to the top plates.

The vessel must be attached to the top plates when they are in the normal weighing position and resting on the load pins. If the vessel is attached to the top plates in the shipping position, there is a possibility that, when lowered, the lift off protection screws will bind in the mounts and destroy weighing accuracy.

With an open end wrench, hold the jam nut of the lift off protection screw to prevent it from rotating. Place a second wrench on the jack nut and loosen it until the top plate contacts the loading pin. Be certain that the loading pin is pressed into the load hole of the load cell. For fixed pin mounts, loading pin must be pressed into the hole on the underside of the top plate. The jack nut has a lip on the underside that centers the lift off protection screw in its hole on the washer plate. Check that the lip is engaged in the hole. Carefully loosen the jack nut further until the top plate is horizontal and is resting solidly on the load pin. Be certain to leave the jack nut in contact with the washer plate during this operation to aid in alignment.

4.2.3 Attaching the Vessel to Top Plates

With the mounts in the position described at the end of Section 4.2.2 above, the vessel may be placed on the top plates of the mounts. Clamp the top plates to the vessel and check that they are level within the specifications of Section 3.4. Shim between the vessel and top plates if necessary. Keep plates level when shimming. In applications with four or more load cells, check that the vessel is loading on all support points and is not resting on two diagonally opposite points only. Check this by attempting to lift the vessel off the top plates by prying with a crowbar. If there is play when this is done, shims may be needed between the vessel and one or more top plates.

The top plates may now be welded or bolted to the vessel. If welding, observe the same precautions discussed in Section 4.2.1. When complete, the mounts can be painted in the same manner as the base plates.

4.2.4 Locking Mounts in Weighing Position

When the installation is complete, screw the jack nut on each mount all the way up on its lift off protection screw and lock it against the top jam nut (see Figure 12). The jack nut must not contact the washer plate during weighing or accuracy will be destroyed. Check that there is no binding between the lift off protection screws in their holes in the washer plates.

4.2.5 Load Cell Wiring

The load cell wiring color code is:

+Excitation--Green	+Signal--White	Screen--Yellow
- Excitation--Black	- Signal--Red	

Route the load cell cables so they will be protected from damage. Provide drip loops in the lines so that liquids spilled on the cables do not run down into either the load cells or the junction box. Connect the load cells to the EL604ET junction box supplied. Connect the junction box to the weight indicator according to the manual supplied with the junction box. Sense leads are strongly recommended, especially if the distance from the junction box to indicator is more than 25 ft.

4.2.6 Trimming

The load cells have outputs matched to within $\pm .07\%$. Because of this accuracy, it should not be necessary to trim the corners; the trimming capability of the EL604ET is disabled for all channels by the presence of jumper wires.

If trimming is required for some reason, the jumper wires can be cut to activate the trimming capability of the junction box. See the enclosed EL604ET manual for details on corner trimming.

4.2.7 Final Checks

Before loading the vessel, check the following:

- Washer plate retaining screws tight?
- Jam nut locked against the top plate?
- Jacking nut locked against the jam nut?
- Load cell mounting screws torqued to correct value?
- All other hardware tight?

4.2.8 Optional Installation Method

If the location of the vessel relative to other equipment is critical, it may be easier to first position the vessel on its support surface. The vessel can then be raised with jacks so the mounts can be fitted to the support surface and vessel simultaneously. All other steps in the installation are as described above.

5. Maintenance

5.1 General

Periodically check that the stainless steel slide plates are smooth, unscratched, and free of paint and grease. If the faces of the plates do become damaged, they may be turned over to get a better surface.

Ensure the O-ring, gasket, and V-ring (side stop and free sliding mounts only) are in place on the loading pins.

Ensure that the teflon coated slide plate on the top of each sliding pin is in good condition.

Ample clearance is provided against debris buildup around the lift off protection screw. Periodically, both the area around the screw and the space beneath the load cell should be cleared of debris buildup to ensure that load shunting to ground does not occur.

5.2 Load Cell Replacement

The following procedure describes changing a load cell. The procedure used to raise the top plates can also be used when changing a load pin, O-ring, load pin seal, or slide plate.

1. The jack nut may be used to raise the top plate and attached vessel off the load cell **only** if the vessel is empty. If emptying the vessel is impractical, it may be raised with external jacks.

Caution

Remove the washer plate screws before using an external jack.

2. To raise the vessel using the jack nut, first hold the jam nut at the top of the lift off protection screw to prevent the screw from turning. Grasp the jack nut with a second wrench and screw the nut down until it contacts the washer plate. Check that the lip on the underside of the nut aligns with the hole in the washer plate. If not, loosening the washer plate retaining screws will usually allow enough freedom for alignment. Continue screwing the jack nut down until the spacer on the screw contacts the underside of the washer plate.
3. Remove the load cell mounting screws.
4. Slide the load cell clear. With the fixed pin mount, the rear end of the load cell must be lifted to disengage the loading pin.

5. To reinstall the load cell, place a dab of grease on the bottom tip of the load pin and insert it into the load cell. Reassemble the load cell to the mount so the longitudinal axis of the load cell is centered on the base plate. Torque the load cell mounting screws in sequence to the values given in the table on Page 9. First torque the mounting screw nearest the load pin, then the screw at the cable end of the load cell. Insufficient torque may allow the rear of the load cell to lift; too much torque may cause screw failure.
6. Lower the vessel onto the load cell by raising the jack nut while holding the jam nut with a second wrench. Lock the jack nut against the jam nut. See Section 4.2 for wiring and trimming information.

6. Replacement Parts

6.1 Fixed Pin Mount

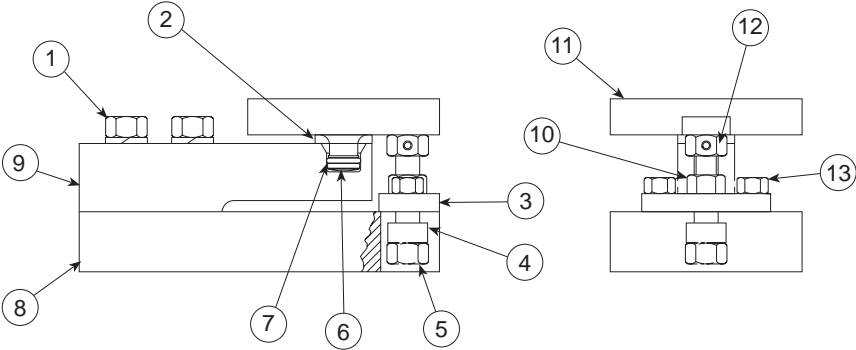

1. Load cell mounting screws
2. Seal
3. Washer plate
4. Spacer
5. Lift off protection screw
6. Fixed load pin
7. O-ring
8. Base plate
9. Load cell
10. Jack nut
11. Top plate
12. Jam nut
13. Washer plate screws

REF. #	DESCRIPTION	1, 2.3KN PART#	5, 10, 23KN PART #	50KN PART #	100KN PART #
2	SEAL	18331	18332	18333	18334
7	O-RING	15325	15325	15326	15327
6	FIXED LOAD PIN	18339	18340	18341	18342

6.2 Side Stop and Free Sliding Mounts

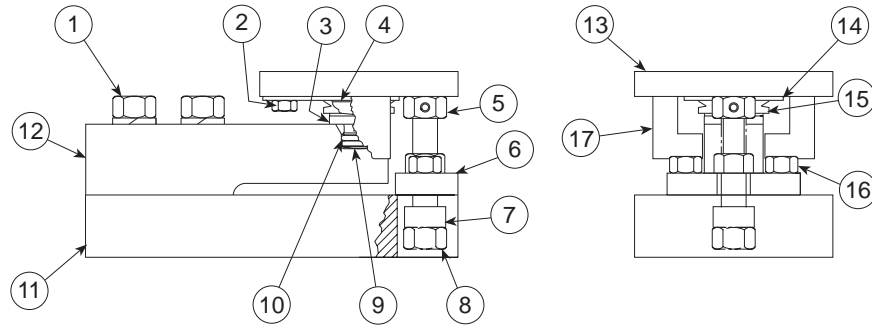

- | | |
|------------------------------|--------------------------------------|
| 1. Load cell mounting screws | 10. O-ring |
| 2. Slide plate bolts | 11. Base plate |
| 3. Seal | 12. Load cell |
| 4. Slide plate (teflon) | 13. Top plate |
| 5. Jam nut | 14. Slide plate (stainless steel) |
| 6. Washer plate | 15. V-ring |
| 7. Spacer | 16. Washer plate screws |
| 8. Lift off protection screw | 17. Side stop (side stop units only) |
| 9. Sliding load pin | |

REF. #	DESCRIPTION	1, 2.3KN PART#	5, 10, 23KN PART #	50KN PART #	100KN PART #
3	SEAL	18331	18332	18333	19334
10	O-RING	15325	15325	15326	15327
9	SLIDING LOAD PIN	18335	18336	18337	18338
15	V-RING	15319	15321	15323	15324
14	SLIDE PLATE (S.S.)	18291	18292	18293	18294
4	SLIDE PLATE (TEFLON)	18327	17902	18329	18330

6.3 Load Cells

LOAD CELL CAPACITY	PART #
1KN (225 LB)	17388
2.3KN (520 LB)	17389
5KN (1,125 LB)	17390
10KN (2,250 LB)	17391
23KN (5,200 LB)	17392
50KN (11,250 LB)	17393
100KN (22,500 LB)	17394

7. Limited Warranty

Rice Lake Weighing Systems (RLWS) warrants that all RLWS brand load cells properly installed by a Distributor or Original Equipment Manufacturer (OEM) will operate per written specifications. All load cell products are warranted against defects in materials and workmanship for two (2) years. Products marked as “waterproof” are warranted against defects in materials and workmanship relating to moisture ingress.

RLWS warrants that the equipment sold hereunder will conform to the current written specifications authorized by RLWS. RLWS warrants the equipment against faulty workmanship and defective materials. If any equipment fails to conform to these warranties, RLWS will, at its option, repair or replace such goods returned within the warranty period subject to the following conditions:

1. Upon discovery by Buyer of such nonconformity, RLWS will be given prompt written notice with a detailed explanation of the alleged deficiencies.
2. Examination of such equipment by RLWS confirms that the nonconformity actually exists, and was not caused by accident, misuse, neglect, alteration, improper installation, improper repair or improper testing; RLWS shall be the sole judge of all alleged non-conformities.
3. Such equipment has not been modified, altered, or changed by any person other than RLWS or its duly authorized repair agents.
4. RLWS will have a reasonable time to repair or replace the defective equipment. Buyer is responsible for shipping charges both ways.
5. In no event will RLWS be responsible for travel time or on-location repairs, including assembly or disassembly of equipment, nor will RLWS be liable for the cost of any repairs made by others.

THESE WARRANTIES EXCLUDE ALL OTHER WARRANTIES, EXPRESSED OR IMPLIED, INCLUDING WITHOUT LIMITATION WARRANTIES OF MERCHANTABILITY OR FITNESS FOR A PARTICULAR PURPOSE. NEITHER RLWS NOR DISTRIBUTOR WILL, IN ANY EVENT, BE LIABLE FOR INCIDENTAL OR CONSEQUENTIAL DAMAGES.

RLWS AND BUYER AGREE THAT RLWS'S SOLE AND EXCLUSIVE LIABILITY HEREUNDER IS LIMITED TO REPAIR OR REPLACEMENT OF SUCH GOODS. IN ACCEPTING THIS WARRANTY, THE BUYER WAIVES ANY AND ALL OTHER CLAIMS TO WARRANTY.

SHOULD THE SELLER BE OTHER THAN RLWS, THE BUYER AGREES TO LOOK ONLY TO THE SELLER FOR WARRANTY CLAIMS.

No terms, conditions, understanding, or agreements purporting to modify the terms of this warranty shall have any legal effect unless made in writing and signed by a corporate officer of RLWS and the Buyer.

©1996 Rice Lake Weighing Systems, Inc. Rice Lake, WI USA. All Rights Reserved.

RICE LAKE WEIGHING SYSTEMS
230 WEST COLEMAN STREET • RICE LAKE, WISCONSIN 54868 • USA
Tel: 715-234-9171 Service Hotline: 715-234-2003 Fax: 715-234-6967