

EtherNet/IP™

Interface for 520i, 720i®, 820i® and 920i® Indicators

Installation and Programming Manual



RICE LAKE
WEIGHING SYSTEMS
To be the best by every measure®

Contents

1.0	Introduction.....	1
2.0	Installation.....	2
2.1	Installing the EtherNet/IP Interface	2
2.1.1	Installing EtherNet/IP Option in the 720i/820i/920i.	2
2.1.2	Installing EtherNet/IP Option in the 520	3
2.2	EtherNet/IP Network Connections	4
2.3	LED Status Indicators.	4
3.0	Configuration Procedure.....	6
3.1	Configuration Procedure for 520, 720i, 820i, 920i and PLC	6
4.0	Commands.....	11
4.1	Output Command Format	11
4.2	Input Command Format	12
4.3	Command Descriptions	13
5.0	Appendix.....	18
5.1	EDS File	18
5.2	EtherNet/IP Interface Specifications	19



Technical training seminars are available through Rice Lake Weighing Systems. Course descriptions and dates can be viewed at www.ricelake.com/training or obtained by calling 715-234-9171 and asking for the training department.



Rice Lake continually offers web-based video training on a growing selection of product-related topics at no cost. Visit www.ricelake.com/webinars.

About This Manual

This manual provides information needed to install and use the Rice Lake Weighing Systems EtherNet/IP™¹ Interface. The EtherNet/IP Interface allows 520, 720i®, 820i®, and 920i® indicators to communicate with an EtherNet/IP network.

See the 520, 720i, 820i, or 920i *Installation Manual* for additional installation information and detailed descriptions of indicator functions.

The EtherNet/IP Interface is installed inside the indicator enclosure. Installation in NEMA 4X stainless steel enclosures permits use in washdown environments.

1. EtherNet/IP™ is a trademark of ControlNet International, Ltd. under license by Open DeviceNet Vendor Association, Inc.



Warning

Some procedures described in this manual require work inside the indicator enclosure. These procedures are to be performed by qualified service personnel only.



Warning

The Ethernet card should NOT be used to communicate between buildings. The Ethernet port is not suitable for connection to circuits used outside the building and is subject to lightning or power faults.



Authorized distributors and their employees can view or download this manual from the Rice Lake Weighing Systems distributor site at www.ricelake.com.

1.0 Introduction

EtherNet/IP (“Ethernet Industrial Protocol”) is an open industrial networking standard that allows control applications to make use of widely-available Ethernet communications components and physical media. EtherNet/IP is based on the IEEE 802.3 Ethernet standard, the TCP/IP protocol suite, and CIP™ (Common Industrial Protocol), the real-time I/O and information protocol used by both DeviceNet™² and ControlNet™³ networks.

The EtherNet/IP Interface returns weight and status information from a 520, 720i, 820i or 920i indicator to the network and provides limited control of indicator functions to the programmer. Indicator configuration and calibration cannot be performed through the EtherNet/IP Interface.

-
2. CIP™ and DeviceNet™ are trademarks of the Open DeviceNet Vendor Association.
 3. ControlNet™ is a trademark of ControlNet International, Ltd.

2.0 Installation

The EtherNet/IP Interface hardware consists of a dual-board option card. EtherNet/IP-specific functions are provided by an EtherNet/IP module, which is factory-installed onto a bus adapter card. The bus adapter card plugs into an open option card slot on the 520, 720i, 820i, or 920i CPU board (or expansion board) and provides power and access from the indicator bus to the EtherNet/IP module.

This section describes the procedures used to install the EtherNet/IP Interface into the 520, 720i, 820i and 920i indicators.

2.1 Installing the EtherNet/IP Interface

Use the following procedure to install the EtherNet/IP Interface into 520, 820i, and 920i indicators.

2.1.1 Installing EtherNet/IP Option in the 720i/820i/920i

Use the following procedure to install the EtherNet/IP Interface in the 720i, 820i or 920i indicator:

1. Disconnect indicator from power source.

Disconnect power before removing indicator backplate.



Warning The 720i, 820i and 920i have no on/off switch. Before opening the unit, ensure the power cord is disconnected from the power outlet.

2. Open indicator enclosure. For indicator models with backplates, place indicator face-down on an antistatic work mat. Remove screws that hold the backplate to the enclosure body.

Use a wrist strap to ground yourself and protect components from electrostatic discharge (ESD) when working inside the indicator enclosure.



Caution

3. Carefully align the large connector (J1) on the bus adapter card with connector J6 on the 820i, J12 on the 720i, J5 or J6 on the 920i CPU board. Press down to seat the bus adapter card in the CPU board connector.
4. Use the screws and lockwashers provided in the option kit to secure the other end of the option card to the threaded standoffs on the CPU board.
5. Wire the card to the network as described in Section 2.2 on page 4.
6. Use cable ties to secure loose cables inside the enclosure.

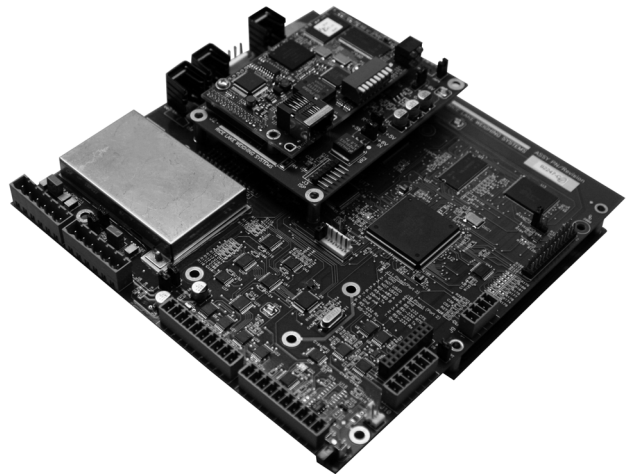

Figure 2-1. Option Installed on 820i CPU Board

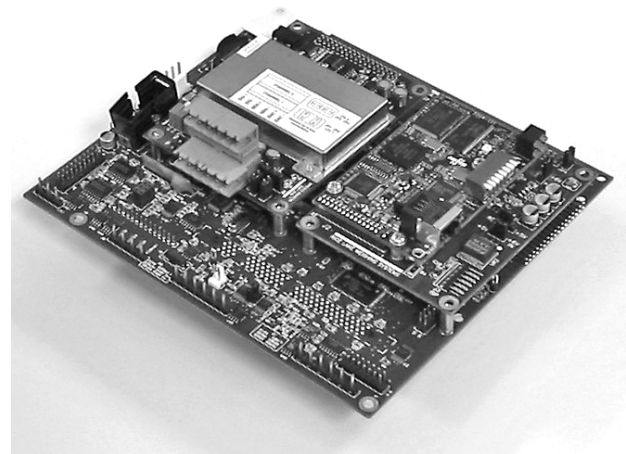

Figure 2-2. Option Installed on 920i CPU Board

7. For indicator models that include a backplate, position the backplate over the enclosure and reinstall the backplate screws. For the 820i and 920i desktop and universal models, use the torque pattern shown in Figure 2-3 to prevent distorting the backplate gasket. Torque screws to 15 in-lb (1.7 N-m)

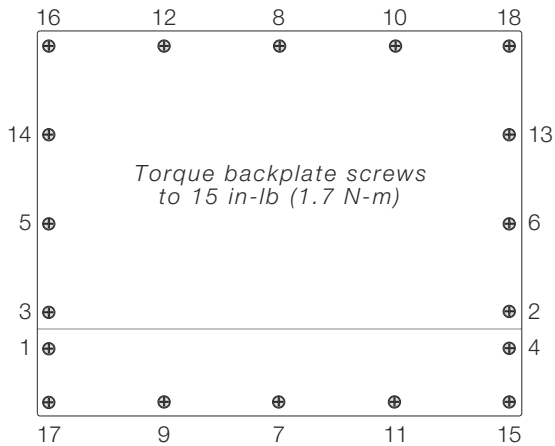

Figure 2-3. 920i Enclosure Backplate

8. Ensure no excess cable is left inside the enclosure and tighten cord grips.
9. Reconnect power to the indicator. The indicator automatically recognizes all installed option cards when the unit is powered on. No hardware-specific configuration is required to identify the newly-installed EtherNet/IP Interface to the system.

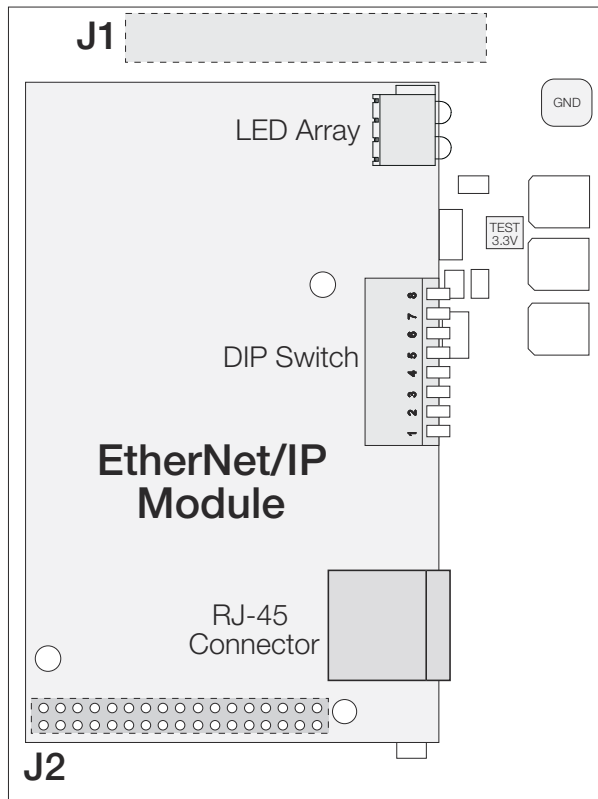

Figure 2-4. Bus Adapter Card and EtherNet/IP Module

2.1.2 Installing EtherNet/IP Option in the 520

Use the following procedure to install the EtherNet/IP Interface in the 520 indicator:

1. Disconnect indicator from power source.

Disconnect power before removing indicator enclosure cover.



Warning

The 520 has no on/off switch. Before opening the unit, ensure the power cord is disconnected from the power outlet.

2. Place indicator on an antistatic work mat. Remove screws that hold the enclosure cover to the enclosure body.



Caution

Use a wrist strap to ground yourself and protect components from electrostatic discharge (ESD) when working inside the indicator enclosure.

3. Carefully align the large option card connector with connector J2 on the CPU board (see Figure 2-5). Press down to seat the option card in the CPU board connector.
4. Use screws provided in the option kit to secure the other end of the option card to the threaded standoffs on the CPU board.
5. Install terminal block end of cable assembly to EtherNet/IP option card.

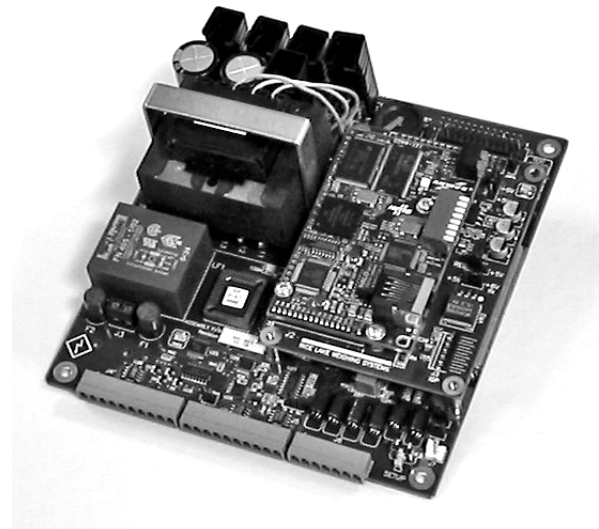

Figure 2-5. Option Installed 520 CPU Board

6. Remove existing cover plate.
7. Re-use kep nuts to secure EtherNet/IP cover plate to standoffs located on inside of enclosure backplate (see Figure 2-6).
8. Once cabling is complete, position the cover over the enclosure and reinstall the screws.
9. Reconnect power to the indicator



Figure 2-6. EtherNet/IP 520 Backplate Cable Assembly

- The indicator automatically recognizes all installed option cards when the unit is powered on. No hardware-specific configuration is required to identify the newly-installed EtherNet/IP interface to the system.

DIP Switch Function

Setting any one of the DIP switches to the ON position will set a static IP address when the indicator is powered up. This IP address will be 192.168.0.XXX where the XXX = DIP switch setting. Example: If switch #8 is ON, and the rest are OFF, the static IP address will be 198.168.0.1. If switch #7 is ON and the rest are OFF, the IP address will be 192.168.0.2.

2.2 EtherNet/IP Network Connections

Feed the EtherNet/IP network cable through the indicator cord grip. Allow enough cable for routing along inside of enclosure to connector on the EtherNet/IP module. Connect network cables to connector on the EtherNet/IP module (see Figure 2-4), then use cable ties to secure network cables to the cable tie mounts.



Note To configure an IP Address, refer to Section 3.1 on page 6.

2.3 LED Status Indicators

An LED array on the EtherNet/IP module provides status information for troubleshooting (see Figure 2-7):

- LED 1 provides status about the link
- LED 2 provides status information about the

EtherNet/IP module

- LED 3 provides network status
- LED 4 flashes whenever a packet is sent or received

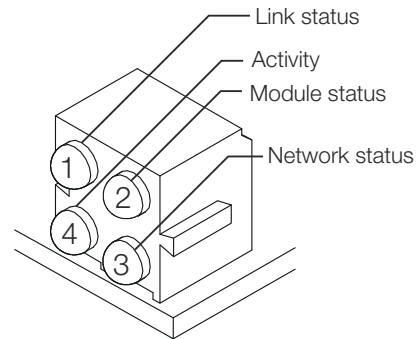

Figure 2-7. EtherNet/IP Status LED Module

LED 1: Link Status

LED 1 Color	State	Description
Green	On	Module has a link
	Off	Link not sensed

Table 2-1. LED 1 Status

LED 2 Color/State	Description
Steady off	No power to module
Steady green	Module operating correctly
Flashing green	Module not configured
Flashing red	Recoverable fault detected
Steady red	Internal error detected
Flashing red/green	Performing power-on self-test

Table 2-2. LED 2 Status

LED 3: Network Status.

LED 3 Color/State	Description
Steady off	No power to module or no IP address assigned
Steady green	At least one EtherNet/IP connection established
Flashing green	No EtherNet/IP connections
Flashing red	Connection time-out
Steady red	Duplicate IP address detected
Flashing red/green	Performing power-on self-test

Table 2-3. LED 3 Status

LED 4: Activity

LED 4 flashes green each time a packet is transmitted or received.

Watchdog LED

A single bi-color LED on the surface of the EtherNet/IP module provides diagnostic information for debugging the module itself. Table 2-4 lists the indications provided by the debugging LED.

Status	Description
Off	No power
Red, 4Hz	DPRAM check fault
Red, 2Hz	ASIC and FLASH ROM check fault
Red, 1Hz	RAM check fault
Green, 2Hz	Module not initialized
Green, 1Hz	Module initialized and running

Table 2-4. Debugging LED Indications

3.0 Configuration Procedure

3.1 Configuration Procedure for 520, 720i, 820i, 920i and PLC

The following steps describe a typical procedure used to configure EtherNet/IP for an *820i* or *920i* indicator and a PLC. EtherNet/IP can be configured using either your web browser or the CompactLogix L32D controller with RSLogix 500 software. Figure 3-1 shows the configuration screen using your web browser.

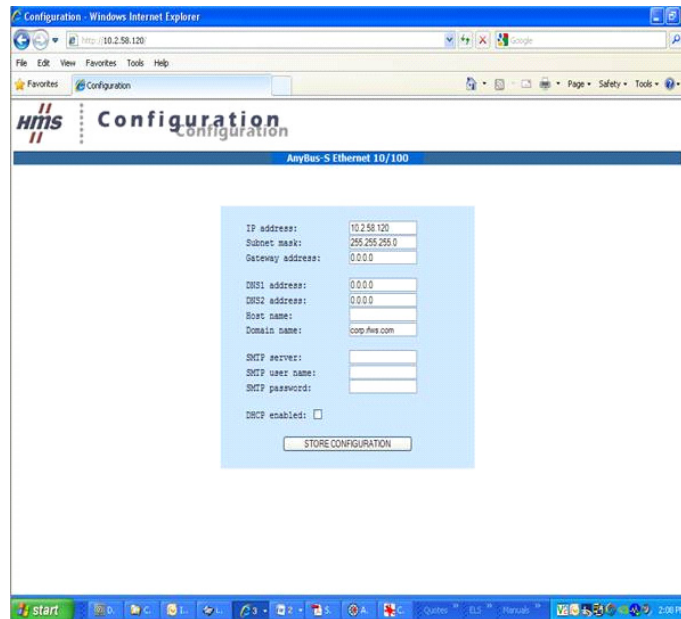

Figure 3-1. EtherNet/IP Configuration Screen Using your Web Browser

The following example uses the Compact Logix L32E controller with RSLogix 5000 software, both from Rockwell Automation.

1. Use *iRev* (920i) or *Revolution III* (520, 720i, or 820i) to configure the scales and scale capacities for the indicator.
2. Calibrate each scale and load any custom program required.
3. Power down the indicator. Install the EtherNet/IP option card (PN 87803). Write down the MAC address shown on the back of the card.
4. Connect the EtherNet/IP option card to the network.
5. Use the MAC address on the back of the card and IPCONFIG Ethernet Configurator software to assign an IP Address to the Ethernet I/P card. Note that the IPCONFIG needs to be loaded on a PC that is on the same network as the Ethernet I/P card.
6. Load RSLogix 5000 onto the same PC running *iRev* or *Revolution III*.
7. Load RSLinx and configure and Comm Driver driver.
8. Use the RS-232 connector to connect the PC to the PLC.
9. Configure the I/O Configuration outlined in the RSLogix manual (1769-UM011E-EN-P, available on the Rockwell Automation website, www.rockwellautomation.com).
10. Use the *Generic Ethernet Module* to add the indicator with EtherNet/IP to the I/O configuration; assign a name as shown in Figure 3-2 on page 7.
11. The module connection parameters are:
 - Input assembly inst. = 100 Size =4
 - Output assembly inst. = 150 Size =4
 - Configuration assembly inst. = 1 Size =0
 - Data type is int.

12. Using RSLinx®, configure an Ethernet driver.
13. Attempt a connection to the PLC using RSLogix 5000. (See the manual, ENET-UM001D-EN-P, available on the Rockwell Automation website, for instructions.)
14. Without a program loaded on the PLC, turn the key to run. Click on the RLWS EtherNet/IP module in the I/O Config window. Another window will open that shows module properties.
15. Click on Module Info and verify that Anybus-S EtherNet/IP is shown as the Product Name. If so, the PLC is communicating with the EtherNet/IP card.
16. Close the Module Info window, then open Controller Tags and verify the three tags assigned for this module. For example, if the name assigned to the module was *RLWS_EthernetIP*, listed tags should include *RLWS_EthernetIP:I* (input buffer), *RLWS_EthernetIP:O* (output buffer), and *RLWS_EthernetIP:C* (control buffer).
17. Data should begin filling the input buffer from the indicator. Initial data received will not make sense, but data in Word 4 should change with changes in the weight applied to the scale.
18. Write the ladder or structured language code for the PLC. When data is acquired from the indicator, a SWPB (swap bits) instruction is required to swap the upper and lower bytes for all four outbound words. Data received must also use the SWPB instruction to swap inbound words. By using the SWPB instruction, words can be MOVED to a destination tag then treated as real values elsewhere in the PLC program. See Figure 3-3.

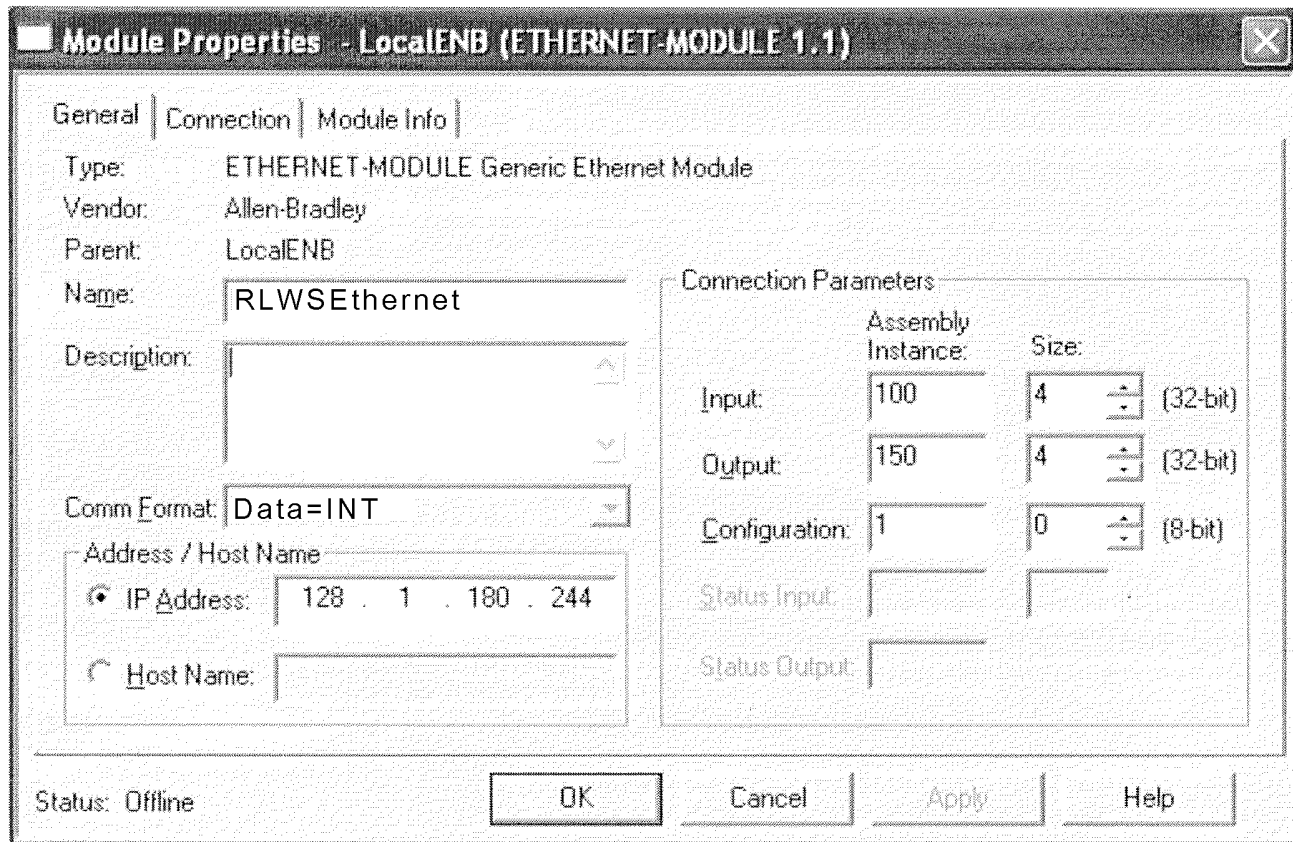

Figure 3-2. Ethernet Modules Display

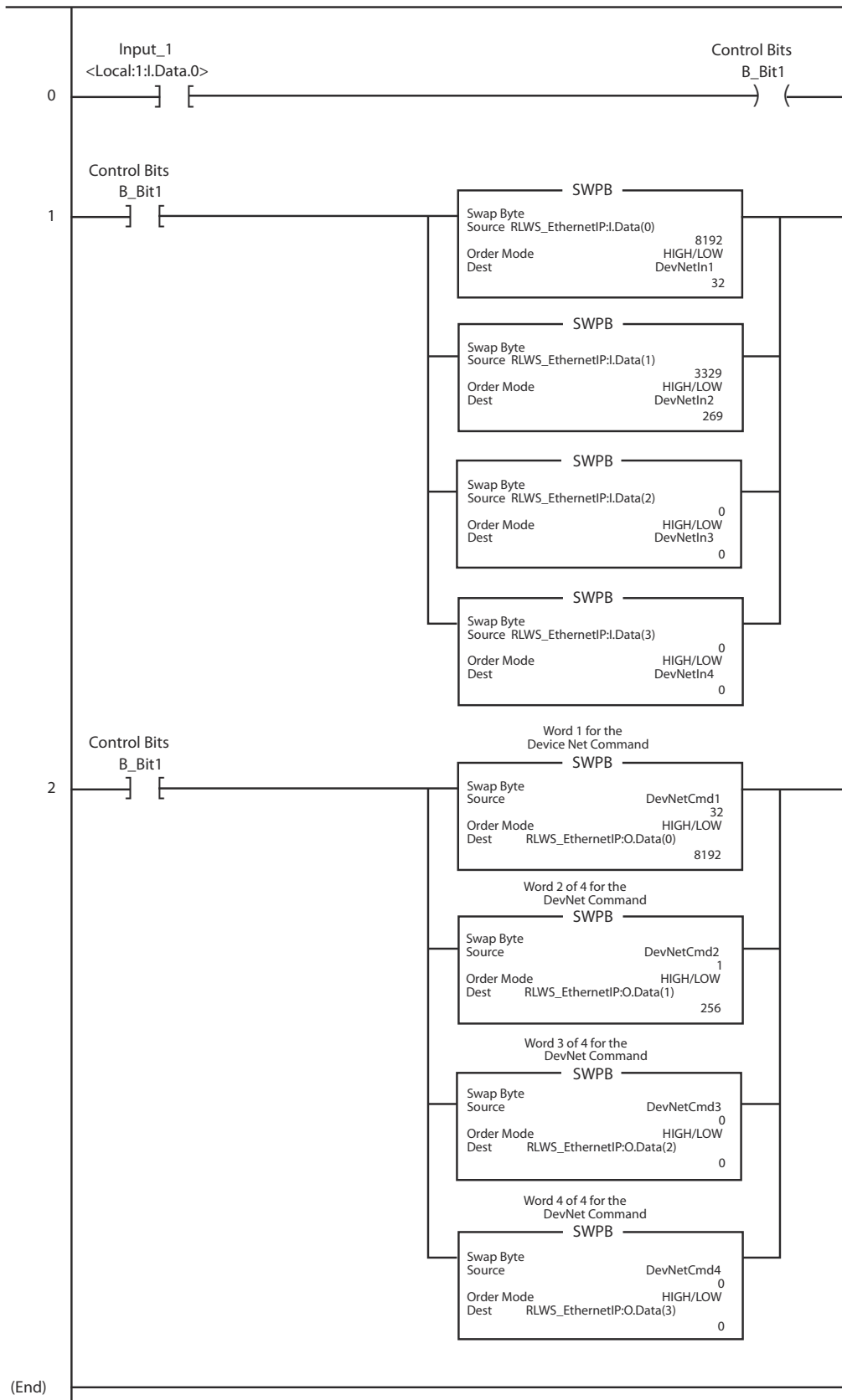

Figure 3-3. Ladder Logic for Bit-swapping

Use the following rungs when using commands
256-323

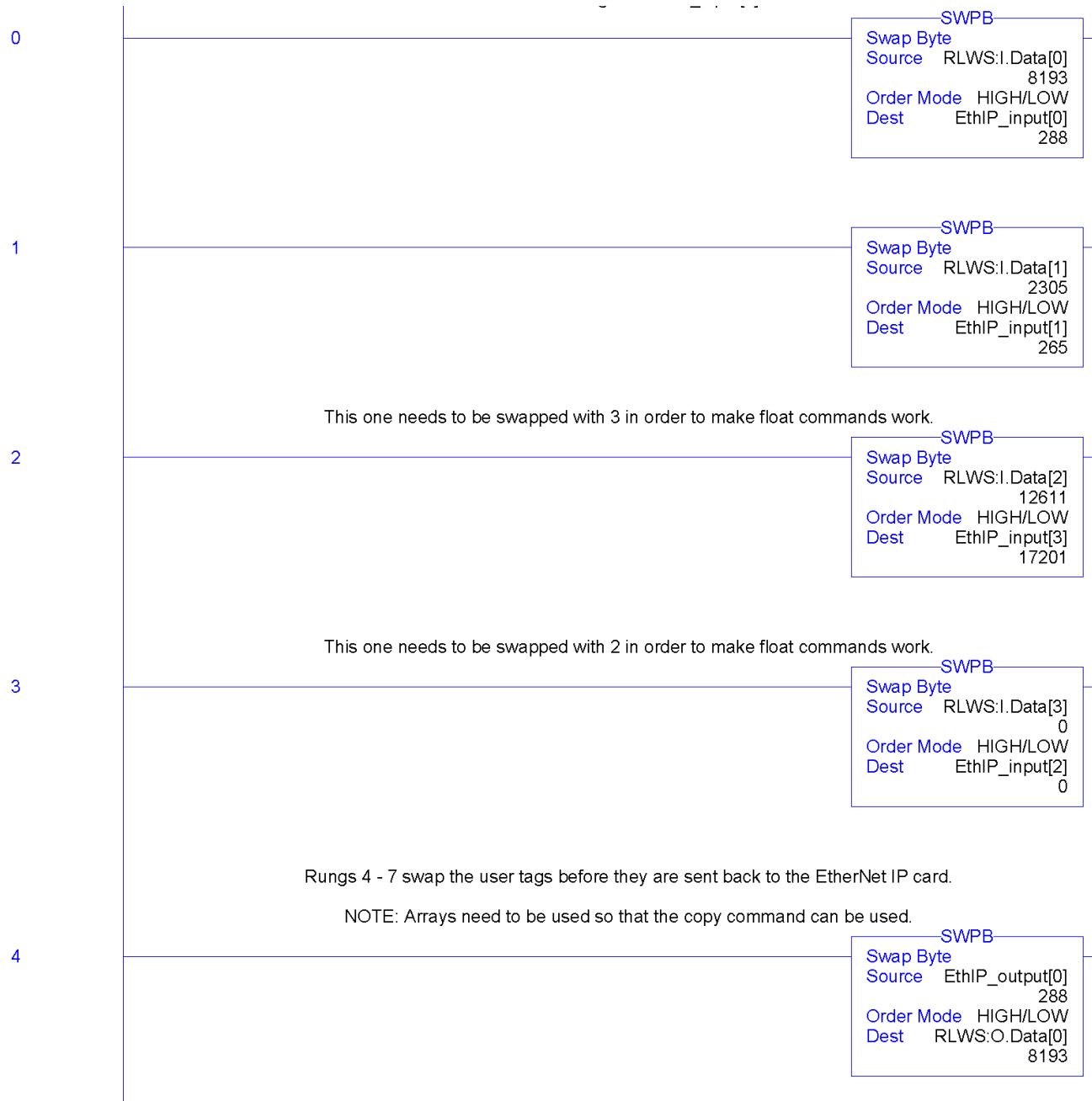

Figure 3-4. Ladder Logic for EtherNet/IP Page 1



Figure 3-5. Ladder Logic for EtherNet/IP Page 2

4.0 Commands

Commands are used by the EtherNet/IP master device to send and receive data from the EtherNet/IP Interface as integer or floating-point data. The master sends eight bytes in the output format (used to write commands to the indicator) and reads eight bytes in the input format (used to read data from the indicator).

Decimal Point Handling

Integer commands return no decimal point information to the master. For example, a value of 750.1 displayed on the indicator is returned to the master as 7501. Floating point commands support decimal point information with no special handling.

4.1 Output Command Format

To perform a command, the master uses the output command format to send four 16-bit words to the EtherNet/IP Interface. These four words contain the command and any parameters necessary to execute it. The output command format is shown in Table 4-1.

Word	Description
Word 1	Command number
Word 2	Parameter
Word 3	Value (MSW)
Word 4	Value (LSW)

Table 4-1. Output Command Format

The contents of each output command format word are described below:

Command number

The number representing the indicator command is sent in the first word. Table 4-2 lists the commands that can be specified for 520, 820i, 720i and 920i indicators.

NOTE: A lockout feature that looks for any change in the output format data is incorporated into the indicator receive mechanism to prevent inundation by the same command. Repeated commands must be separated by any other valid command/parameter/value combination.

Decimal	Hex	Command
0	0x000	Return Status and Weight (integer)
1	0x001	Display Channel
2	0x002	Display Gross Weight
3	0x003	Display Net Weight
4	0x004	Display Count
9	0x009	Gross/Net key press (toggle)
10	0x00A	Zero

Table 4-2. Remote Commands

Decimal	Hex	Command
11	0x00B	Display Tare
12	0x00C	Enter Tare
13	0x00D	Acquire Tare
14	0x00E	Clear Tare
16	0x010	Primary Units
17	0x011	Secondary Units
18	0x012	Tertiary Units
19	0x013	Units key press (toggle units)
20	0x014	Print Request
21	0x015	Display Accumulator
22	0x016	Clear Accumulator
23	0x017	Push Weight to Accumulator
32	0x020	Return Gross (integer)
33	0x021	Return Net (integer)
34	0x022	Return Tare (integer)
35	0x023	Return Count
37	0x025	Return Current Display (integer)
38	0x026	Return Accumulator (integer)
39	0x027	Return Rate of Change (integer)
40	0x028	Return Peak (integer)
95	0x05F	Set Batching State
96	0x060	Batch Start
97	0x061	Batch Pause
98	0x062	Batch Reset
99	0x063	Batch Status
112	0x070	Lock Indicator Front Panel
113	0x071	Unlock Indicator Front Panel
114	0x072	Set Digital Output ON
115	0x073	Set Digital Output OFF
116	0x074	Read Digital I/O Status
128	0x80	Enable Bus Command Handler
253	0x0FD	No operation
254	0x0FE	Reset Indicator
256	0x100	Return Status as Weight (float)
268	0x10C	Set Tare (float)
288	0x120	Read Gross (float)
289	0x121	Read Net (float)
290	0x122	Read Tare (float)
291	0x123	Read Piece Count (float)
293	0x125	Read Current Display (float)

Table 4-2. Remote Commands (Continued)

Decimal	Hex	Command
294	0x126	Read Accumulator (float)
295	0x127	Read Rate of Change (float)
296	0x128	Read Peak (float)
304	0x130	Set Setpoint Value (float)
305	0x131	Set Setpoint Hysteresis (float)
306	0x132	Set Setpoint Bandwidth (float)
307	0x133	Set Setpoint Preact (float)
320	0x140	Read Setpoint Value (float)
321	0x141	Read Setpoint Hysteresis (float)
322	0x142	Read Setpoint Bandwidth (float)
323	0x143	Read Setpoint Preact (float)
368	0x170	Set Register
402	0x192	Get Register

Table 4-2. Remote Commands (Continued)

Parameter value

To allow communication with a multi-scale indicator, the scale number is sent in the second word of the output command format. Zero (0) represents the current scale. Certain commands require a parameter other than a scale number, such as a slot number, setpoint number, or other selection parameter. See the command descriptions in Section 4.3 on page 13 for specific command requirements.

Value

The third and fourth words of the output format are used to pass value data on certain commands. Values entered in these words are treated as unsigned long integers or floating-point values, depending on the command.

4.2 Input Command Format

In response to a command, the EtherNet/IP Interface returns data and status information to the master as four 16-bit words. This information is returned in the input command format shown in Table 4-3.

The value type can be set for those commands that do not specify integer or floating point data by sending a command 0x000 to specify integer data or command 0x100 for floating-point data. The value type is returned in the status word (bit 14) of the input format.

Word	Description
Word 1	Command number
Word 2	Status
Word 3	Value (MSW)
Word 4	Value (LSW)

Table 4-3. Input Command Format

Command number

The first word echoes the command number. If the command fails or is not recognized, the negative of the command number is returned to signal the error.

Status Data

Indicator status data is returned in the second word (see Table 4-4). Batch commands return batch status in place of the low byte (see Table 4-5). Setpoint commands return batch status in the low byte of the status word and the setpoint number in the high byte.

Word 2 Bit	Indicator Status Data	
	Value=0	Value=1
00	Error	No error
01	Tare not entered	Tare entered
02	Not zero	Center of zero
03	Weight invalid	Weight OK
04	Standstill	In motion
05	Primary units	Other units
06	Tare not acquired	Tare acquired
07	Gross weight	Net weight
08	Channel number (NOTE: Value 0 represents scale #32)	
09		
10		
11		
12		
13	Not used	
14	Integer data	Floating point data
15	Positive weight	Negative weight

Table 4-4. Indicator Status Data Format

Word 2 Bit	Batch Function Status Data	
	Value=0	Value=1
00	Digital input 4 OFF (520) Error	Digital input 4 ON (520) No error
01	Digital input 3 OFF	Digital input 3 ON
02	Digital input 2 OFF	Digital input 2 ON
03	Digital input 1 OFF	Digital input 1 ON
04	Batch not paused	Batch paused
05	Batch not running	Batch running
06	Batch not stopped	Batch stopped
07	Alarm OFF	Alarm ON

Table 4-5. Batch Function Status Data Format

Value

Weight data is returned to the master in the third and fourth words of the input command format, depending on the command and the value type. The weight data returned is the displayed weight after the command is executed, unless the command specifies otherwise.

4.3 Command Descriptions

NOTE: For all commands that require a scale number, a value of 0 indicates the current scale. Unless otherwise specified, the indicator returns weight and status data for the specified scale.

Return Status and Current Weight as Integer

Command: 0, 0x000

Parameter: Scale number

Command 0 returns the status and weight of the specified scale in integer format, without changing the display. This command also causes the format-independent commands to return a value in the integer format.

Display Channel

Command: 1, 0x001

Parameter: Scale number

Command 1 causes the weight of the specified scale to be displayed and returned in its current mode and format. This command is valid for the 920i only.

Display Gross Weight

Command: 2, 0x002

Parameter: Scale number

Command 2 causes the gross weight of the specified scale to be displayed and returned.

Display Net Weight

Command: 3, 0x003

Parameter: Scale number

Command 3 causes the net weight of the specified scale to be displayed and returned.

Display Piece Count

Command: 4, 0x004

Parameter: Scale number

Command 4 causes the piece count on the specified scale to be displayed and returned. This command is valid only for the 520 indicator, and only if count mode is enabled.

Gross/Net Key Press (toggle mode)

Command: 9, 0x009

Parameter: Scale number

Command 9 toggles between gross and net mode (and count mode, if enabled). If a scale number other than 0 is specified, the action may not be evident until the specified scale is displayed.

Zero

Command: 10, 0x00A

Command 10 performs a zero operation on the current scale.

Display Tare

Command: 11, 0x00B

Parameter: Scale number

Command 11 causes the tare weight on the specified scale to be displayed. If a scale number other than 0 is specified, the indicator first causes the specified scale to be displayed. The tare data continues being returned even if the display times out and returns to another mode.

Enter Tare (integer)

Command: 12, 0x00C

Parameter: Scale number

Value: Tare weight

Command 12 enters a tare for the scale selected. Tare data must be in integer format. The indicator continues to return weight data in the current mode for the specified scale.

Acquire Tare (simulate TARE key press)

Command: 13, 0x00D

Parameter: Scale number

Command 13 acquires a tare based on the weight currently on the specified scale. The indicator continues to return weight data in the current mode for the specified scale.

Clear Tare

Command: 14, 0x00E

Parameter: Scale number

Command 14 clears the tare for the specified scale. The indicator continues to return weight data in the current mode for the specified scale.

Primary Units

Command: 16, 0x010

Parameter: Scale number

Command 16 switches the current format of the specified scale to the primary units configured for that scale.

Secondary Units

Command: 17, 0x011

Parameter: Scale number

Command 17 switches the current format of the specified scale to the secondary units configured for that scale.

Tertiary Units

Command: 18, 0x012

Parameter: Scale number

Command 18 switches the current format of the specified scale to the tertiary units configured for that scale, if available. This command is valid for the *920i* only.

Units Key Press (toggle units)

Command: 19, 0x013

Parameter: Scale number

Command 19 toggles the current format of the specified scale to the next units configured for that scale, as available.

Print Request

Command: 20, 0x014

Parameter: Scale number

Command 20 causes the indicator to execute a print command for the current scale.

Display Accumulator

Command: 21, 0x015

Parameter: Scale number

Command 21 causes the value of the accumulator for the specified scale to be displayed and returned. This command is only valid if the accumulator for the specified scale is enabled.

Clear Accumulator

Command: 22, 0x016

Parameter: Scale number

Command 22 clears the value of the accumulator for the specified scale. This command is only valid if the accumulator for the specified scale is enabled.

Push Weight to Accumulator

Command: 23, 0x017

Parameter: Scale number

Command 23 adds the net weight on the specified scale to the value of the accumulator for the specified scale. The scale must return to net zero between accumulations. The indicator returns the accumulated weight data for the specified scale. This command is only valid if the accumulator for the specified scale is enabled.

Return Gross as Integer

Command: 32, 0x020

Parameter: Scale number

Command 32 returns the gross weight value for the specified scale as an integer.

Return Net as Integer

Command: 33, 0x021

Parameter: Scale number

Command 33 returns the net weight value for the specified scale as an integer.

Return Tare as Integer

Command: 34, 0x022

Parameter: Scale number

Command 34 returns the tare weight value for the specified scale as an integer.

Return Piece Count

Command: 35, 0x023

Parameter: Scale number

Command 35 returns the piece count value for the specified scale. This command is valid only for the *520* indicator, and only if count mode is enabled.

Return Current Display as Integer

Command: 37, 0x025

Parameter: Scale number

Command 37 returns the weight value for the specified scale as currently displayed. This may include gross, net, tare, piece count, or accumulator values, as enabled. On the *920i*, the weight value is returned in the mode used to display a scale widget.

Return Accumulator as Integer

Command: 38, 0x026

Parameter: Scale number

Command 38 returns the accumulator value for the specified scale. This command is only valid if the accumulator for the specified scale is enabled.

Return Rate of Change as Integer

Command: 39, 0x027

Parameter: Scale number

Command 39 returns the current rate of change value for the specified scale. This command is valid only for the *720i*, *820i*, *920i*.

Return Peak as Integer

Command: 40, 0x028

Parameter: Scale number

Command 40 returns the net peak value for the specified scale. This command is valid only for the *520* indicator, and only if the peak hold function is enabled.

Set Batching State

Command: 95, 0x05F

Parameter: State (0 = off; 1 = auto; 2 = manual)

Command 95 sets the batching (BATCHNG) parameter. Indicator status is returned with the current weight for the last scale specified.

Batch Start

Command: 96, 0x060

Parameter: Scale number

Command 96 starts a batch program from the current step after a stop, pause, or reset. Batch status is returned with the current weight for the specified scale.

Batch Pause

Command: 97, 0x061

Parameter: Scale number

Command 97 pauses a batch program at the current step. Batch status is returned with the current weight for the specified scale.

Batch Reset

Command: 98, 0x062

Parameter: Scale number

Command 98 stops a batch program and resets it to the first batch step. Batch status is returned with the current weight for the specified scale.

Batch Status

Command: 99, 0x063

Parameter: Scale number

Command 99 returns the status of a batch. Batch status is returned with the current weight for the specified scale.

Lock Front Panel of Indicator

Command: 112, 0x070

Parameter: Scale number

Command 112 disables all the keys on the front panel of the indicator. Indicator status is returned with the current weight for the specified scale.

Unlock Front Panel of Indicator

Command: 113, 0x071

Parameter: Scale number

Command 113 re-enables all the keys on the front panel of the indicator. Indicator status is returned with the current weight for the specified scale.

Set Digital Output ON

Command: 114, 0x072

Parameter: Slot number

Value: Bit number

Command 114 sets the specified digital output ON (active). Use slot number 0 for onboard digital outputs. Indicator status is returned with the current weight for the last scale specified.

Set Digital Output OFF

Command: 115, 0x073

Parameter: Slot number

Value: Bit number

Command 115 sets the specified digital output OFF (inactive). Use slot number 0 for onboard digital outputs. Indicator status is returned with the current weight for the last scale specified.

Read Digital I/O

Command: 116, 0x074

Parameter: Slot number

Command 116 returns the status for all digital I/O in the specified slot in words 3 and 4 (On the 520, status is returned only for the digital inputs.) Use slot number 0 for onboard digital I/O. Indicator status is returned in the status area for the last scale specified.

Enable Bus Command Handler

Command: 128, 0x80

Parameter: None

Command 128 enables the bus command handler in a user program in a 920i indicator only. While this handler is enabled, all other PLC commands are disabled.

No Operation

Command: 253, 0x0FD

Parameter: Scale number

Command 253 provides a command to use between operations, as necessary, without causing the indicator to perform any action. Indicator status and weight for the specified scale is returned.

Reset Indicator

Command: 254, 0x0FE

Parameter: None

Command 254 provides a command to remotely reset the indicator. No data is returned.

Return Status and Current Weight as Float

Command: 256, 0x100

Parameter: Scale number

Command 256 returns the status and weight of the specified scale in floating-point format, without changing the display. This command also causes the format-independent commands to return a value in the floating-point format.

Set Tare as Float

Command: 268, 0x10C

Parameter: Scale number

Value: Tare weight

Command 268 enters a tare for the scale selected in floating-point format. The indicator returns the tare weight as taken, or 0 for no tare.

Read Gross Weight as Float

Command: 288, 0x120

Parameter: Scale number

Command 288 returns the gross weight value for the specified scale in floating-point format.

Read Net Weight as Float

Command: 289, 0x121

Parameter: Scale number

Command 289 returns the net weight value for the specified scale in floating-point format.

Read Tare as Float

Command: 290, 0x122

Parameter: Scale number

Command 290 returns the tare weight value for the specified scale in floating-point format.

Read Piece Count as Float

Command: 291, 0x123

Parameter: Scale number

Command 291 returns the piece count value for the specified scale in floating-point format. This command is only valid for the 520, and only if count mode is enabled.

Read Current Display as Float

Command: 293, 0x125

Parameter: Scale number

Command 293 returns the weight value for the specified scale as currently displayed in floating-point format. This may include gross, net, tare, piece count, rate-of-change, or accumulator values, as enabled. On the 820i/920i, the weight value is returned in the mode used to display a scale widget.

Read Accumulator as Float

Command: 294, 0x126

Parameter: Scale number

Command 294 returns the accumulator value for the specified scale in floating-point format. This command is only valid if the accumulator for the specified scale is enabled.

Read Rate of Change as Float

Command: 295, 0x127

Parameter: Scale number

Command 295 returns the current rate of change value for the specified scale in floating-point format. This command is only valid for the 820i and 920i.

Read Peak Value as Float

Command: 296, 0x128

Parameter: Scale number

Command 296 returns the net peak value for the specified scale in floating-point format. This command is only valid for the 520, and only if the peak hold function is enabled.

Set Setpoint Value as Float

Command: 304, 0x130

Parameter: Setpoint number

Value: Target value

Command 304 sets the target value for the specified setpoint in floating-point format. This command is only valid if the setpoint is enabled and requires a target value.

Set Setpoint Hysteresis as Float

Command: 305, 0x131

Parameter: Setpoint number

Value: Hysteresis value

Command 305 sets the hysteresis value for the specified setpoint in floating-point format. This command is only valid if the setpoint is enabled and requires a hysteresis value.

Set Setpoint Bandwidth as Float

Command: 306, 0x132

Parameter: Setpoint number

Value: Bandwidth value

Command 306 sets the bandwidth value for the specified setpoint in floating-point format. This command is only valid if the setpoint is enabled and requires a bandwidth value.

Set Setpoint Preact as Float

Command: 307, 0x133

Parameter: Setpoint number

Value: Preact value

Command 307 sets the preact value for the specified setpoint in floating-point format. This command is only valid if the setpoint is enabled and requires a preact value.

Read Setpoint Value as Float

Command: 320, 0x140

Parameter: Setpoint number

Command 320 returns the target value for the specified setpoint in floating-point format. This command is only valid if the setpoint is enabled and requires a target value.

Read Setpoint Hysteresis as Float

Command: 321, 0x141

Parameter: Setpoint number

Command 321 returns the hysteresis value for the specified setpoint in floating-point format. This command is only valid if the setpoint is enabled and requires a hysteresis value.

Read Setpoint Bandwidth as Float

Command: 322, 0x142

Parameter: Setpoint number

Command 322 returns the bandwidth value for the specified setpoint in floating-point format. This command is only valid if the setpoint is enabled and requires a bandwidth value.

Read Setpoint Preact as Float

Command: 323, 0x143

Parameter: Setpoint number

Command 323 returns the preact value for the specified setpoint in floating-point format. This command is only valid if the setpoint is enabled and requires a preact value.

Set Register

Command: 368

Registers: 1 thru 256

Command 368 sets register value. 1 through 128 are integer and 129 through 256 are real. This command is only valid for the *720i* PCE version.

Get Register

Command: 402

Registers: 1 thru 256

Command 402 returns register value. 1 through 128 are integer and 129 through 256 are real. This command is only valid for the *720i* PCE version.

5.0 Appendix

5.1 EDS File

The EDS file for the EtherNet/IP adapter, shown below, is included on the CD that comes with the option. The EDS file must be installed in the host device to enable communication with the indicator.

```
[File]
DescText = "HMS AnyBus-Communicator EtherNet/IP";
CreateDate = 04-02-2003;
CreateTime = 14:40:00;
ModDate = 07-22-2003;
ModTime = 10:45:00;
Revision = 1.2;

[Device]
VendCode = 90;
VendName = "HMS Networks";
ProdType = 12;
ProdTypeStr = "Communication Adapter";
ProdCode = 1;
MajRev = 1;
MinRev = 17;
ProdName = "Anybus-C EtherNet/IP";
Catalog = "Anybus-C EtherNet/IP";

[Device Classification]
Class1 = EtherNetIP;

[Params]
Param1 =
    0,                $ first field shall equal 0
    ,,               $ path size,path
    0x0000,           $ descriptor
    0xC7,             $ data type : 16-bit Unsigned Integer
    2,                $ data size in bytes
    "Output Size",   $ name
    "",              $ units
    "",              $ help string
    0, 504, 16,       $ min, max, default data values
    0, 0, 0, 0,       $ mult, dev, base, offset scaling not used
    0, 0, 0, 0,       $ mult, dev, base, offset link not used
    0;                $ decimal places not used

Param2 =
    0,                $ first field shall equal 0
    ,,               $ path size,path
    0x0000,           $ descriptor
    0xC7,             $ data type : 16-bit Unsigned Integer
    2,                $ data size in bytes
    "Input Size",    $ name
    "",              $ units
    "",              $ help string
    0, 504, 16,       $ min, max, default data values
    0, 0, 0, 0,       $ mult, dev, base, offset scaling not used
    0, 0, 0, 0,       $ mult, dev, base, offset link not used
    0;                $ decimal places not used

[Connection Manager]
```

```

Connection1 =
    0x04010002,

    0x44240405,

    ,Param1,,
    ,Param2,,
    ,,
    ,,
    "ABC-EIP IO Connection",
    "",
    "20 04 24 01 2C 96 2C 64";

```

```

$ trigger & transport
$ 0-15 = supported transport classes (class 1)
$ 16 = cyclic (1 = supported)
$ 17 = change of state (0 = not supported)
$ 18 = on demand (0 = not supported)
$ 19-23 = reserved (must be zero)
$ 24-27 = exclusive owner
$ 28-30 = reserved (must be zero)
$ 31 = client 0 (don't care for classes 0 and 1)
$ point/multicast & priority & realtime format
$ 0 = O=>T fixed (1 = supported)
$ 1 = O=>T variable (0 = not supported)
$ 2 = T=>O fixed (1 = supported)
$ 3 = T=>O variable (0 = not supported)
$ 4-7 = reserved (must be zero)
$ 8-10 = O=>T header (4 byte run/idle)
$ 11 = reserved (must be zero)
$ 12-14 = T=>O header
$ 15 = reserved (must be zero)
$ 16-19 = O=>T point-to-point
$ 20-23 = T=>O multicast
$ 24-27 = O=>T scheduled
$ 28-31 = T=>O scheduled
$ O=>T RPI,Size,Format
$ T=>O RPI,Size,Format
$ config part 1 (dynamic assemblies)
$ config part 2 (module configuration)
$ connection name
$ Help string
$ exclusive output path

```

5.2 EtherNet/IP Interface Specifications

Power Requirements

Bus Adapter Card with EtherNet/IP Module, DC Power:

Supply voltage: 6 VDC, supplied by 520/920i bus
 Typical current draw: 270 mA
 Power consumption: 1.62 W

Indicators, Typical AC Load:

520 Power (TRMS):3.51 W
 Current (TRMS):33.7 mA

820i Power (TRMS):2.18 W
 Current (TRMS):28.9 mA

920i Power (TRMS):2.18 W
 Current (TRMS):28.9 mA

Communications Specifications

EtherNet/IP Network Communications:
 Twisted-pair cabling at 10 or 100Mbps

Environmental Specifications

Temperature: -10° to +40° C (14° to 104° F)

Conformance

EtherNet/IP™
conformance tested

The Anybus-S EtherNet/IP Interface has been tested by ODVA's independent test lab and found to comply with the ODVA composite conformance test, revision 3.



The EtherNet/IP Interface has been found in accordance with EMC directive 89/336/EEC for European standards EN 50081-2 and EN 61000-6-2.

EtherNet/IP Interface Limited Warranty

Rice Lake Weighing Systems (RLWS) warrants that all RLWS equipment and systems properly installed by a Distributor or Original Equipment Manufacturer (OEM) will operate per written specifications as confirmed by the Distributor/OEM and accepted by RLWS. All systems and components are warranted against defects in materials and workmanship for one year.

RLWS warrants that the equipment sold hereunder will conform to the current written specifications authorized by RLWS. RLWS warrants the equipment against faulty workmanship and defective materials. If any equipment fails to conform to these warranties, RLWS will, at its option, repair or replace such goods returned within the warranty period subject to the following conditions:

- Upon discovery by Buyer of such nonconformity, RLWS will be given prompt written notice with a detailed explanation of the alleged deficiencies.
- Individual electronic components returned to RLWS for warranty purposes must be packaged to prevent electrostatic discharge (ESD) damage in shipment. Packaging requirements are listed in a publication, "Protecting Your Components From Static Damage in Shipment," available from RLWS Equipment Return Department.
- Examination of such equipment by RLWS confirms that the nonconformity actually exists, and was not caused by accident, misuse, neglect, alteration, improper installation, improper repair or improper testing; RLWS shall be the sole judge of all alleged non-conformities.
- Such equipment has not been modified, altered, or changed by any person other than RLWS or its duly authorized repair agents.
- RLWS will have a reasonable time to repair or replace the defective equipment. Buyer is responsible for shipping charges both ways.
- In no event will RLWS be responsible for travel time or on-location repairs, including assembly or disassembly of equipment, nor will RLWS be liable for the cost of any repairs made by others.

THESE WARRANTIES EXCLUDE ALL OTHER WARRANTIES, EXPRESSED OR IMPLIED, INCLUDING WITHOUT LIMITATION WARRANTIES OF MERCHANTABILITY OR FITNESS FOR A PARTICULAR PURPOSE. NEITHER RLWS NOR DISTRIBUTOR WILL, IN ANY EVENT, BE LIABLE FOR INCIDENTAL OR CONSEQUENTIAL DAMAGES.

RLWS AND BUYER AGREE THAT RLWS' SOLE AND EXCLUSIVE LIABILITY HEREUNDER IS LIMITED TO REPAIR OR REPLACEMENT OF SUCH GOODS. IN ACCEPTING THIS WARRANTY, THE BUYER WAIVES ANY AND ALL OTHER CLAIMS TO WARRANTY.

SHOULD THE SELLER BE OTHER THAN RLWS, THE BUYER AGREES TO LOOK ONLY TO THE SELLER FOR WARRANTY CLAIMS.

NO TERMS, CONDITIONS, UNDERSTANDING, OR AGREEMENTS PURPORTING TO MODIFY THE TERMS OF THIS WARRANTY SHALL HAVE ANY LEGAL EFFECT UNLESS MADE IN WRITING AND SIGNED BY A CORPORATE OFFICER OF RLWS AND THE BUYER.

© 2012 Rice Lake Weighing Systems, Inc. Rice Lake, WI USA. All Rights Reserved.

RICE LAKE WEIGHING SYSTEMS • 230 WEST COLEMAN STREET • RICE LAKE, WISCONSIN 54868 • USA



230 W. Coleman St. • Rice Lake, WI 54868 • USA
U.S. 800-472-6703 • Canada/Mexico 800-321-6703
International 715-234-9171

www.ricelake.com
[mobile: m.ricelake.com](http://m.ricelake.com)

© 2011 Rice Lake Weighing Systems

PN 88537 08/12