



7000 Series Indicators Instruction Manual



T71P



T71XW

TABLE OF CONTENTS

1.	INTRODUCTION.....	5
1.1	Safety Precautions	5
1.1.1	Relay Option Safety Precautions.....	5
1.2	Overview of Parts and Controls.....	6
1.3	Control Functions.....	10
2.	INSTALLATION	11
2.1	Unpacking	11
2.2	External Connections.....	11
2.2.1	Scale Base with Connector to T71P.....	11
2.2.2	Scale Base with Connector to T71XW.....	11
2.2.3	RS232 Interface Cable to T71P.....	11
2.2.4	AC Power to T71P.....	11
2.2.5	AC Power to T71XW.....	11
2.2.6	Battery Power to T71P.....	11
2.2.7	Mounting Bracket Attachment	12
2.3	Internal Connections	12
2.3.1	Opening the Housing.....	12
2.3.2	Scale Base without Connector to T71P or T71XW.....	12
2.3.3	RS232 Interface Cable to T71XW.....	13
2.3.4	Footswitch to T71P or T71XW.....	13
2.3.5	T71P Housing Orientation.....	13
2.3.6	Mounting Bracket.....	13
3.	SETTINGS.....	14
3.1	Menu Structure	14
3.2	Menu Navigation	16
3.3	Calibration Menu	17
3.3.1	Zero Calibration	17
3.3.2	Span Calibration	17
3.3.3	3 Point Linearity Calibration	18
3.3.4	5 Point Linearity Calibration	18
3.3.5	Calibration Test.....	19
3.3.6	Geographical Adjustment Factor.....	20
3.3.7	End Calibration.....	20
3.4	Setup Menu	20
3.4.1	Reset.....	20
3.4.2	Dual Scale	20
3.4.3	Range1.....	20
3.4.4	Range2.....	21
3.4.5	Capacity1	21
3.4.6	Capacity2	21
3.4.7	Graduation1	21
3.4.8	Graduation2	22
3.4.9	Power Unit	22
3.4.10	Zero Range.....	22
3.4.11	Auto Tare	22
3.4.12	Accumulate	23
3.4.13	Retain Zero.....	23
3.4.14	Legal For Trade.....	23
3.4.15	Beep Volume	23
3.4.16	Beep Signal.....	23
3.4.17	Key Beep	24
3.4.18	Library	24
3.4.19	Alibi.....	24
3.4.20	End Setup	24
3.5	Readout Menu.....	24
3.5.1	Reset.....	24
3.5.2	Language.....	24
3.5.3	Stable Range.....	25

3.5.4	Filter	25
3.5.5	Auto Zero Tracking	25
3.5.6	Backlight	25
3.5.7	Auto Off Timer	26
3.5.8	Gross Indicator	26
3.5.9	End Readout	26
3.6	Mode Menu	26
3.6.1	Reset	26
3.6.2	Weighing Mode	26
3.6.3	Parts Counting Mode	26
3.6.4	Parts Counting Optimization	27
3.6.5	Percent Weighing Mode	27
3.6.6	Dynamic Weighing Mode	27
3.6.7	Check Weighing Mode	27
3.6.8	End Mode	27
3.7	Unit Menu	28
3.7.1	Reset	28
3.7.2	Kilogram Unit	28
3.7.3	Pound Unit	28
3.7.4	Gram Unit	28
3.7.5	Ounce Unit	28
3.7.6	Pound Ounce Unit	28
3.7.7	Tonne Unit	29
3.7.8	Custom Unit	29
3.7.9	End Unit	29
3.8	GMP Menu	30
3.8.1	Reset	30
3.8.2	Date	30
3.8.3	Time	30
3.8.4	User ID	31
3.8.5	Project ID	31
3.8.6	Scale ID	31
3.8.7	End GMP	31
3.9	Print1, Print2 Menus	31
3.9.1	Reset	31
3.9.2	Print Stable Data Only	31
3.9.3	Auto Print	32
3.9.4	Print Content Sub-menu	32
3.9.5	Layout Sub-menu	38
3.9.6	List	38
3.9.7	End Print1, End Print2	38
3.10	COM1, COM2 Menus	39
3.10.1	Reset	39
3.10.2	Baud	39
3.10.3	Parity	39
3.10.4	Stop Bit	39
3.10.5	Handshake	39
3.10.6	Address	40
3.10.7	Alternate Command Sub-menu	40
3.10.8	End COM1, End COM2	40
3.11	I-O Menu	40
3.11.1	Reset	40
3.11.2	External Input	41
3.11.3	Input Beep	41
3.11.4	Relay Output Sub-menu	41
3.11.5	End I-O	42
3.12	Menu Lock Menu	42
3.12.1	Reset	42
3.12.2	Lock Calibration	42
3.12.3	Lock Setup	42
3.12.4	Lock Readout	43

3.12.5	Lock Mode	43
3.12.6	Lock Unit	43
3.12.7	Lock Print1	43
3.12.8	Lock Print2	43
3.12.9	Lock COM1	43
3.12.10	Lock COM2	43
3.12.11	Lock GMP	44
3.12.12	Lock I-O	44
3.12.13	End Menu Lock	44
3.13	Key Lock Menu	44
3.13.1	Reset	44
3.13.2	Lock All Buttons	44
3.13.3	Lock Off Button	44
3.13.4	Lock Zero Button	44
3.13.5	Lock Print Button	45
3.13.6	Lock Unit Button	45
3.13.7	Lock Function Button	45
3.13.8	Lock Mode Button	45
3.13.9	Lock Tare Button	45
3.13.10	Lock Menu Button	45
3.13.11	Lock Library Button	46
3.13.12	Lock Info Button	46
3.13.13	End Lock	46
3.14	End Menu	46
3.15	Securing the Menu and Key Lock menu settings	46
4.	OPERATION	47
4.1	Turning Indicator On/Off	47
4.2	Zero Operation	47
4.3	Manual Tare	47
4.4	Preset Tare	47
4.5	Auto Tare	47
4.6	Changing Units of Measure	47
4.7	Printing Data	48
4.8	Dual Scale Operation	48
4.9	Application Modes	48
4.9.1	Weighing	48
4.9.2	Parts Counting	48
4.9.3	Percent Weighing	50
4.9.4	Dynamic Weighing	50
4.9.5	Check Weighing	51
4.9.6	PCS (Pieces Counting) Check Weighing	50
4.10	Library	53
4.10.1	Storing Library Data	54
4.10.2	Retrieving Data	57
4.10.3	Editing Stored Data	57
4.10.4	Deleting Stored Data	58
4.11	Accumulation and Statistics	58
4.11.1	Accumulating Displayed Values	58
4.11.2	Viewing Statistics Data	58
4.11.3	Clearing Statistics Data	58
4.12	Alibi Memory	59
4.12.1	Viewing Alibi Data	59
4.12.2	Printing Alibi Data	58
5.	SERIAL COMMUNICATION	61
5.1	Interface Commands	61
5.2	Output Format	61
5.3	Printout Examples	62
6.	LEGAL FOR TRADE	64
6.1	Settings	64
6.2	Verification	64
6.3	Sealing	64

6.3.1	Physical Seals	64
6.3.2	Audit Trail Seal (USA Only)	65
7.	MAINTENANCE	67
7.1	Cleaning	67
7.2	Troubleshooting	67
7.3	Service Information	68
8.	TECHNICAL DATA	69
8.1	Specifications	69
8.2	Accessories and Options	70
8.3	Drawings and Dimensions	71
8.4	Compliance.....	72

1. INTRODUCTION

1.1 Safety Precautions



CAUTION: READ ALL SAFETY WARNINGS BEFORE INSTALLING, MAKING CONNECTIONS, OR SERVICING THIS EQUIPMENT. FAILURE TO COMPLY WITH THESE WARNINGS COULD RESULT IN PERSONAL INJURY AND/OR PROPERTY DAMAGE. RETAIN ALL INSTRUCTIONS FOR FUTURE REFERENCE.

- Verify that the input voltage range printed on the data label matches the local AC power to be used.
- Make sure that the power cord does not pose a potential obstacle or tripping hazard.
- Use only approved accessories and peripherals.
- Operate the equipment only under ambient conditions specified in these instructions.
- Disconnect the equipment from the power supply when cleaning.
- Do not operate the equipment in hazardous or unstable environments.
- Do not immerse the equipment in water or other liquids.
- Service should only be performed by authorized personnel.
- The T71XW is supplied with a grounded power cable. Use only with a compatible grounded power outlet.

1.1.1 Relay Option Safety Precautions

This equipment may have an optional AC or DC Relay Option board installed. This option allows external devices to be controlled by the equipment.



WARNING: ELECTRICAL SHOCK HAZARDS EXIST WITHIN THE HOUSING. THE HOUSING SHOULD ONLY BE OPENED BY AUTHORIZED AND QUALIFIED PERSONNEL. REMOVE ALL POWER CONNECTIONS TO THE UNIT BEFORE OPENING. IF THE UNIT CONTAINS AN OPTIONAL RELAY CONTROL BOARD, ADDITIONAL AC OR DC POWER CONNECTIONS MAY STILL EXIST WITHIN THE HOUSING.

Before making connections to the Relay terminals, remove power from the system. If the system contains an optional rechargeable battery system, be sure to use the **ON/ZERO Off** button to fully turn off the system after removing the AC power plug.

More detailed installation instructions are included with the Relay Option Kit.

1.2 Overview of Parts and Controls

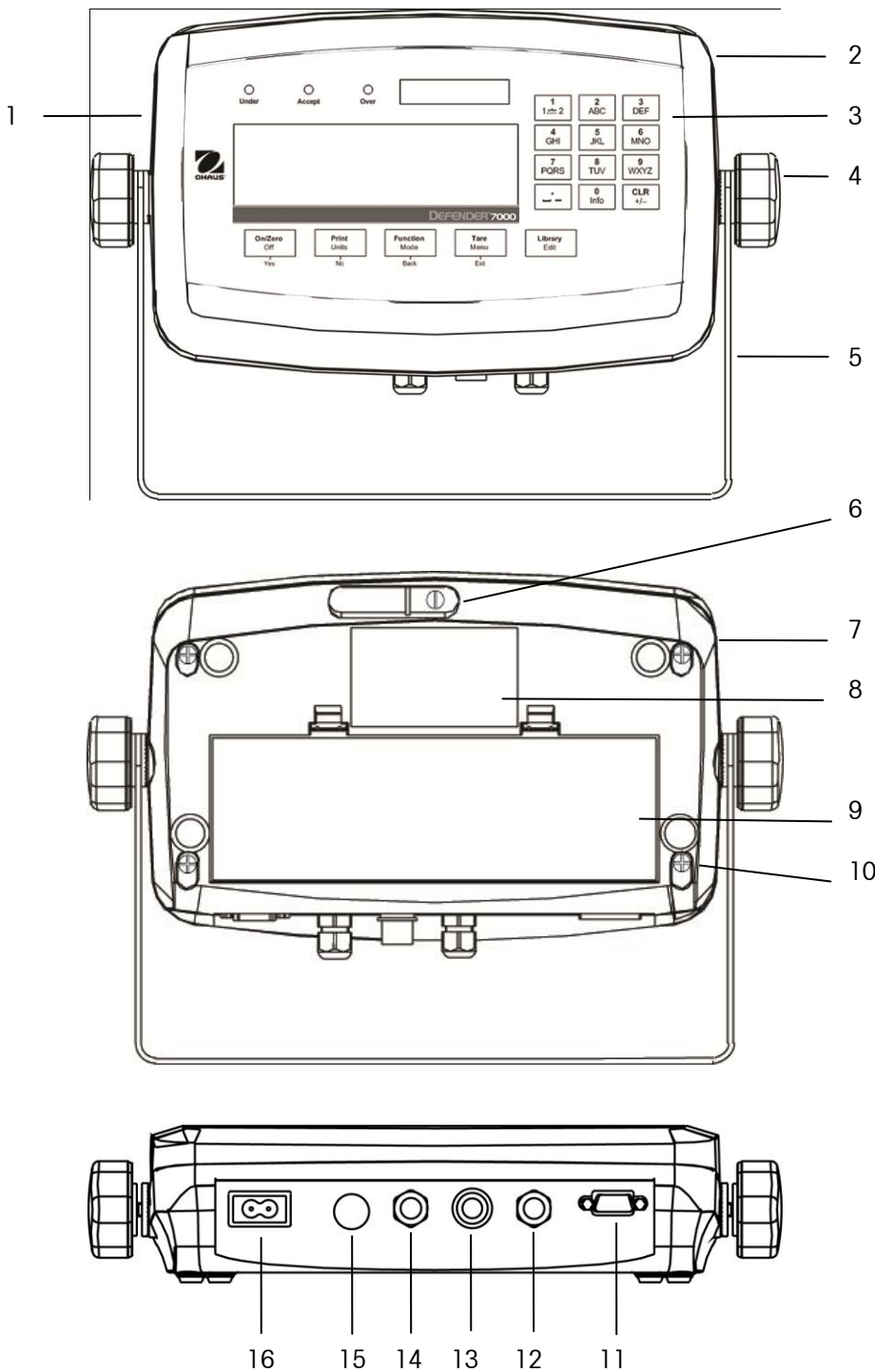

Item	Description
1	Data label (on side)
2	Front housing
3	Control Panel
4	Adjusting knob (2)
5	Mounting bracket
6	Security screw
7	Rear housing
8	Data label
9	Battery cover
10	Screw (4)
11	RS232 connector
12	Cable gland for Scale 2 load cell cable or option cable
13	Load cell connector for Scale 1
14	Cable gland for Scale 1 load cell cable
15	Hole plug for option
16	Power receptacle

Figure 1-1. T71P Indicator

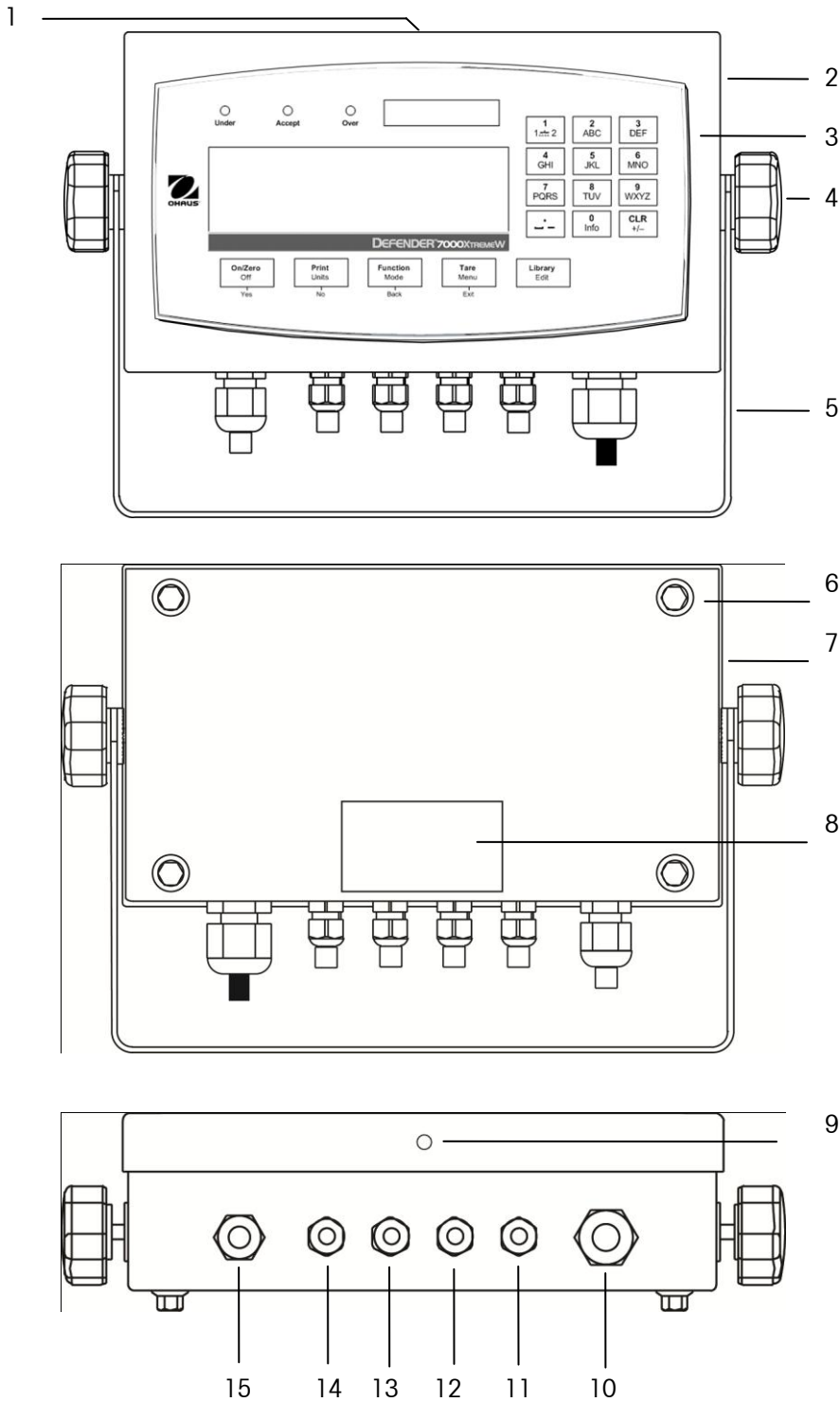

Item	Description
1	Data label (on top)
2	Front housing
3	Control Panel
4	Adjusting knob (2)
5	Mounting bracket
6	Bolt (4)
7	Rear housing
8	Data label
9	Location for security screw
10	Power cord
11	Cable gland for Scale 1 load cell cable
12	Cable gland for Scale 2 load cell cable
13	Cable gland for RS232 option, RS485/RS422 option or External Input cable
14	Cable gland for RS232 cable
15	Cable gland for Relay option cable

Figure 1-2. T71XW Indicator

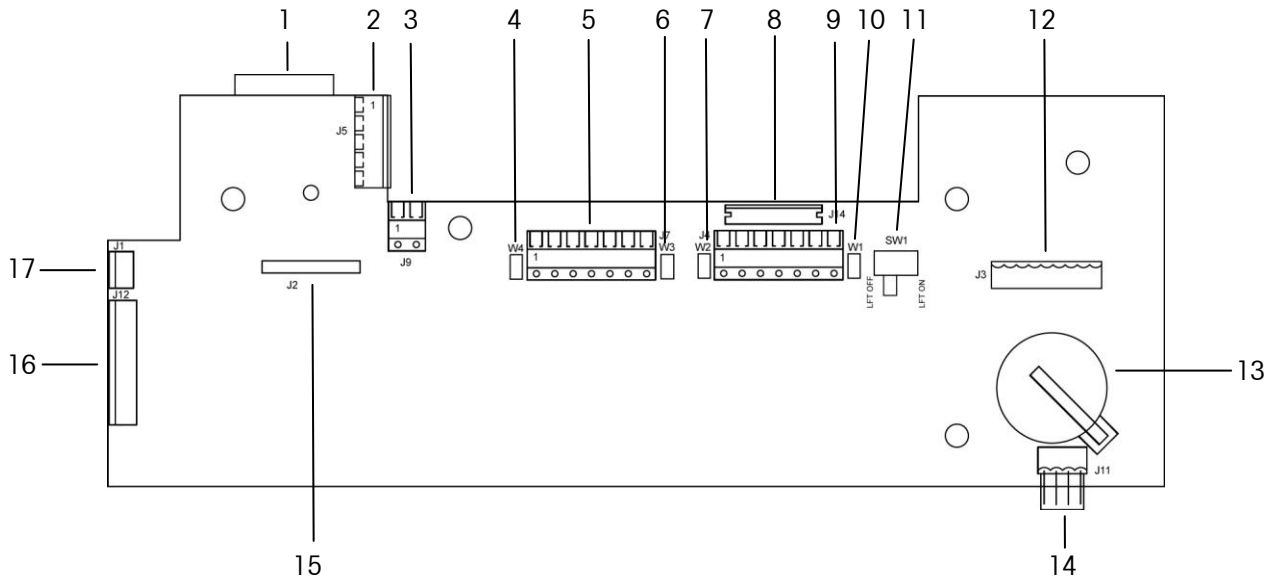

Item	Description
1	RS232 connector (T71P only)
2	RS232 terminal block J5 (T71XW only)
3	External input terminal block J9
4	Scale 2 sense jumper W4
5	Scale 2 load cell terminal block J7
6	Scale 2 sense jumper W3
7	Scale 1 sense jumper W2
8	Scale 1 load cell connector J14 (T71P only)
9	Scale 1 load cell terminal block J4

Item	Description
10	Scale 1 sense jumper W1
11	Security switch SW1
12	Rechargeable battery option connection J3 (T71P opposite side)
13	Real time clock battery
14	DC power connection
15	Alibi option connection
16	Option connection
17	Battery connection (T71P only)

Figure 1-3. Main PC Board

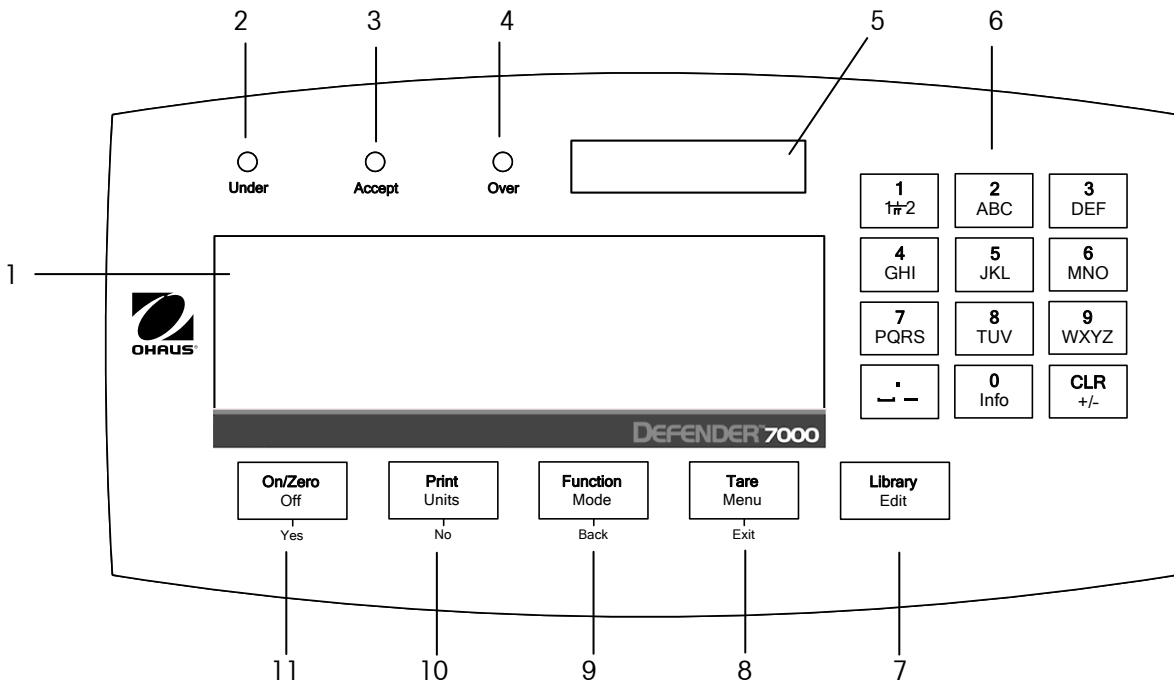

Item	Description
1	Display window
2	UNDER LED
3	ACCEPT LED
4	OVER LED
5	Capacity label window
6	Keypad

Item	Description
7	LIBRARY Edit button
8	TARE Menu Exit button
9	FUNCTION Mode Back button
10	PRINT Units No button
11	ON/ZERO Off Yes button

Figure 1-4. Control Panel

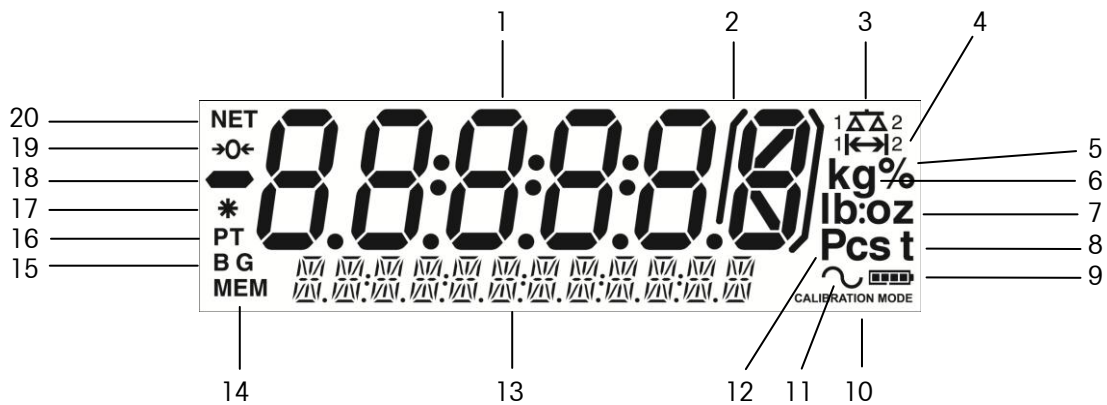







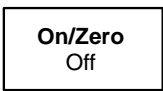
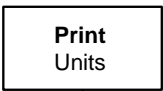
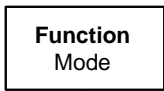

Item	Description
1	7-segment display
2	Brackets (not used)
3	Scale symbol
4	Range symbol
5	Kilogram, gram symbols
6	Percent symbol
7	Pound, Ounce, Pound:Ounce symbols
8	Tonne symbol
9	Battery charge symbol
10	Calibration Mode symbol

Item	Description
11	Dynamic symbol
12	Pieces symbol
13	14-segment display
14	Memory symbol
15	Brutto, Gross symbols
16	Preset Tare, Tare symbols
17	Stable weight symbol
18	Negative symbol
19	Center of Zero symbol
20	NET symbol

Figure 1-5. Display

1.3 Control Functions

Button	 Yes	 No	 Back	 Exit	 Edit
Primary Function (Short Press)	ON/ZERO Turn indicator on. Zero the display.	PRINT Send the displayed value to the COM port.	FUNCTION Initiate the function of the current application mode.	TARE Perform a tare operation.	LIBRARY Display the library data.
Secondary Function (Long Press)	Off Turn indicator off.	Units Change the weighing unit.	Mode Change the application mode.	Menu Enter the menu. View the Audit Trail event counters (extended press)	Edit Enable editing the current library record.
Menu Function (Short Press)	Yes Accept the current menu or setting.	No Advance to the next menu or setting. Increment the displayed value.	Back Go back to the previous menu or setting. Decrement the displayed value.	Exit Exit the menu. Abort the calibration in progress.	
Library Function (Short Press)	Yes Accept the current setting.	No Advance to the next library or setting. Increment the displayed value.	Back Go back to the previous library or setting. Decrement the displayed value.	Exit Exit the library.	

Button		 			
Primary Function (Short Press)	1 Enter 1 on the display.	2ABC through 9WXYZ Enter alphanumeric values on the display using the multi-tap text entry method.	. Enter decimal point, space or dash on the display.	0 Enter 0 on the display.	CLR Clear the last character from the display
Secondary Function (Long Press)	1s2 Change the display between Scale 1 and Scale 2.			Info Show the Accumulation statistics on the display.	+/- Change the polarity of the displayed value.

2. INSTALLATION

2.1 Unpacking

Unpack the following items:

- T71P or T71XW indicator
- AC power cord (T71P only)
- Mounting bracket
- Knobs (2)
- Capacity label sheet
- Sealing kit
- Instruction manual CD
- Warranty card

2.2 External Connections

2.2.1 Scale Base with Connector to T71P

Ohaus bases with a circular connector can be attached to the external load cell connector (Figure 1-1, item 13). Refer to Section 2.3.2 for bases without a connector.

To make the connection, plug the base's connector onto the external load cell connector, and then rotate the locking ring clockwise.

2.2.2 Scale Base with Connector to T71XW

To connect an Ohaus base with a circular connector to the T71XW (which does not have an external connector), the Load Cell Cable Adapter Kit p/n 80500736 may be used to make the connection. Only use this attachment method if the system will not be used in a Washdown environment. This cable connects to the terminal block inside the T71XW and has an external connector on the other end.

2.2.3 RS232 Interface Cable to T71P

Connect the optional RS232 cable to the RS232 connector (Figure 1-1, item 11).

Pin	Connection
1	N/C
2	TXD
3	RXD
4	N/C
5	Ground
6	N/C
7	CTS
8	RTS
9	N/C

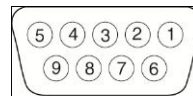

Figure 2-1. RS232 Connector

2.2.4 AC Power to T71P

Connect the AC power cord (supplied) to the power receptacle (Figure 1-1, item 16), then connect the AC plug to an electrical outlet.

2.2.5 AC Power to T71XW





Connect the power cord to a properly grounded electrical outlet.

2.2.6 Battery Power to T71P

The T71P indicator can be operated on batteries (not supplied). The indicator will automatically switch to battery power if there is a power failure or the power cord is removed.

Remove the battery cover (Figure 1-1, item 9) and install 6 C-size (LR14) batteries in the orientation shown in the battery compartment. Re-install the battery cover.

During battery operation, the battery symbol indicates the battery charge level. The indicator will automatically turn off when the batteries are fully discharged.

Level	Charge Remaining
	0 to 5 %
	5 to 25 %
	26 to 50 %
	51 to 75 %
	76 to 100 %

2.2.7 Mounting Bracket Attachment

Position the wall bracket over the threaded holes on each side of the indicator and install the knobs (See Figures 1-1 and 1-2). Adjust the indicator to the desired angle and tighten the knobs.

2.3 Internal Connections

Some connections require the housing to be opened.



WARNING: ELECTRICAL SHOCK HAZARDS EXIST WITHIN THE HOUSING. THE HOUSING SHOULD ONLY BE OPENED BY AUTHORIZED AND QUALIFIED PERSONNEL. REMOVE ALL POWER CONNECTIONS TO THE UNIT BEFORE OPENING. IF THE UNIT CONTAINS AN OPTIONAL RELAY CONTROL BOARD, ADDITIONAL AC OR DC POWER CONNECTIONS MAY STILL EXIST WITHIN THE HOUSING.

2.3.1 Opening the Housing

T71P

Remove the four Phillips head screws from the rear housing. Remove the front housing being careful not to disturb the internal connections. Once all connections are made, reattach the front housing.

T71XW

Remove the four 8mm hex head bolts from the rear housing. Open the housing by carefully pulling the front housing forward. Once all connections are made, reattach the front housing. Tighten the bolts to 2.5 N m (20-25 in lb) torque to ensure a watertight seal.

2.3.2 Scale Base without Connector to T71P or T71XW

Bases without a circular connector must be attached to one of the internal load cell connectors on the main pc board. Pass the load cell cable through a cable gland (Figure 1-1, item 14 or Figure 1-2, item 11 or 12) and attach it to terminal block J4 (Figure 1-3, item 9) or terminal block J7 (Figure 1-3, item 5). Tighten the cable gland to secure the cable and maintain a tight seal.

Terminal Block J4 (Scale 1)		Terminal Block J7 (Scale 2)	
Pin	Connection	Pin	Connection
1	+ Excitation	1	+ Excitation
2	+ Sense	2	+ Sense
3	+ Signal	3	+ Signal
4	Ground	4	Ground
5	- Signal	5	- Signal
6	- Sense	6	- Sense
7	- Excitation	7	- Excitation

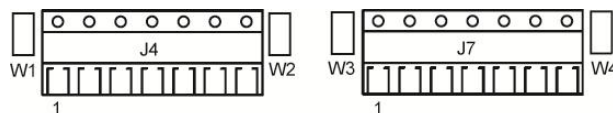

Jumper connections

When a 4-wire load cell is attached to terminal block J4, jumpers W1 and W2 must be installed.
 When a 4-wire load cell is attached to terminal block J7, jumpers W3 and W4 must be installed.
 When a 6-wire load cell is attached to terminal block J4, jumpers W1 and W2 must be removed.
 When a 6-wire load cell is attached to terminal block J7, jumpers W3 and W4 must be removed.

2.3.3 RS232 Interface Cable to T71XW

Pass the optional RS232 cable through the cable gland (Figure 1-2, item 14) and attach it to the terminal block J5 (Figure 1-3, item 2). Tighten the cable gland to secure the cable and maintain a tight seal.

Pin	Connection
1	RTS
2	TXD
3	RXD
4	CTS
5	Ground

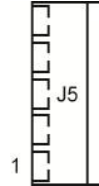

2.3.4 Footswitch to T71P or T71XW

Pass the optional footswitch cable through the cable gland (Figure 1-1, item 12 or Figure 1-2, item 13) and attach it to the terminal block J9 (Figure 1-3, item 3). Tighten the cable gland to secure the cable and maintain a tight seal.

2.3.5 T71P Housing Orientation

The T71P is delivered in the wall mount orientation, with connections exiting below the display. The rear housing may be reversed so the connections exit above the display. This orientation is convenient when the T71P is placed horizontally on a bench. To reverse the rear housing, remove the four Phillips head screws, carefully rotate the housing 180° and re-install the screws.

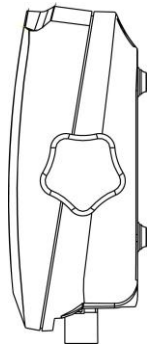

Figure 2-3. Wall Mount Configuration

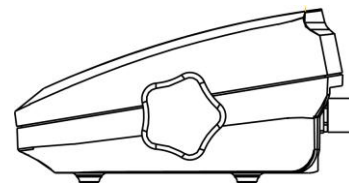

Figure 2-4. Bench Top Configuration

2.3.6 Mounting Bracket

Attach the bracket to a wall or table using fasteners (not supplied) that are appropriate for the type of mounting surface. The bracket will accommodate up to 6 mm (1/4") diameter screws. Locate the mounting holes as shown in Figure 2-5.

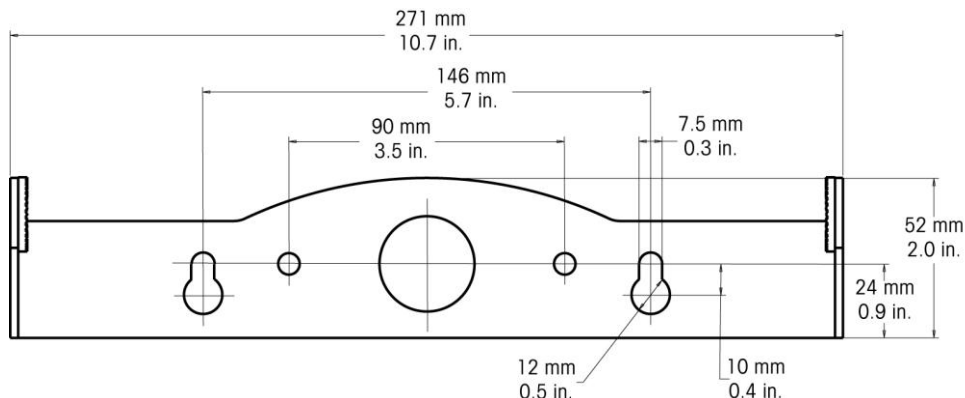

Figure 2-5. Mounting Bracket Dimensions

3. SETTINGS

3.1 Menu Structure

CALIBRATION	SETUP	READOUT	MODE	UNIT	GMP	PRINT1
<ul style="list-style-type: none"> • ZERO1 ¹⁾ • ZERO2 ¹⁾ • SPAN1 ¹⁾ • SPAN2 ¹⁾ • 3 PT LINEAR1 ¹⁾ • 3 PT LINEAR2 ¹⁾ • 5 PT LINEAR1 ¹⁾ • 5 PT LINEAR2 ¹⁾ • CAL TEST1 • CAL TEST2 • GEO ¹⁾ • END CAL 	<ul style="list-style-type: none"> • RESET <ul style="list-style-type: none"> • NO • YES • DUAL SCALE ²⁾ <ul style="list-style-type: none"> • OFF • ON • RANGE1 ²⁾ <ul style="list-style-type: none"> • SINGLE • DUAL • RANGE2 ²⁾ <ul style="list-style-type: none"> • SINGLE • DUAL • CAPACITY1 ²⁾ <ul style="list-style-type: none"> • 1...999999 • CAPACITY2 ²⁾ <ul style="list-style-type: none"> • 1...999999 • GRADUATION1 ²⁾ <ul style="list-style-type: none"> • 0.0001...100 • GRADUATION2 ²⁾ <ul style="list-style-type: none"> • 0.0001...100 • POWER ON UNIT ²⁾ <ul style="list-style-type: none"> • AUTO • KILOGRAM • POUND • GRAM • OUNCE • POUND OUNCE • TONNE • CUSTOM • ZERO RANGE ²⁾ <ul style="list-style-type: none"> • 2% • 100% • AUTO TARE ²⁾ <ul style="list-style-type: none"> • OFF • ON • ACCEPT <ul style="list-style-type: none"> • OFF • 0.5 SECOND • 1 SECOND • 2 SECONDS • 5 SECONDS • ACCUMULATION ²⁾ <ul style="list-style-type: none"> • OFF • MANUAL • AUTO • RETAIN ZERO ²⁾ <ul style="list-style-type: none"> • OFF • ON • LEGAL FOR TRADE <ul style="list-style-type: none"> • OFF • ON • BEEPER VOLUME <ul style="list-style-type: none"> • OFF • LOW • HI • BEEPER SIGNAL <ul style="list-style-type: none"> • OFF • ACCEPT • UNDER • OVER • UNDER-OVER • KEY BEEP <ul style="list-style-type: none"> • OFF • ON • LIBRARY <ul style="list-style-type: none"> • OFF • ON • ALIBI <ul style="list-style-type: none"> • OFF • ON • END SETUP 	<ul style="list-style-type: none"> • RESET <ul style="list-style-type: none"> • NO • YES • LANGUAGE <ul style="list-style-type: none"> • ENGLISH • SPANISH • FRENCH • GERMAN • ITALIAN • STABLE RANGE ²⁾ <ul style="list-style-type: none"> • 0.5d • 1d • 2d • 3d • 5d • FILTER <ul style="list-style-type: none"> • LOW • MEDIUM • HI • AUTO ZERO ²⁾ <ul style="list-style-type: none"> • OFF • 0.5d • 1d • 3d • BACKLIGHT <ul style="list-style-type: none"> • OFF • ON • AUTO <ul style="list-style-type: none"> • 1 MINUTE • 2 MINUTES • 5 MINUTES • GROSS INDICATOR <ul style="list-style-type: none"> • OFF • GROSS • BRUTTO • END READOUT 	<ul style="list-style-type: none"> • RESET <ul style="list-style-type: none"> • NO • YES • WEIGH ²⁾ <ul style="list-style-type: none"> • OFF • ON • COUNT ²⁾ <ul style="list-style-type: none"> • OFF • ON • PC OPTIMIZE <ul style="list-style-type: none"> • OFF • ON • PERCENT ²⁾ <ul style="list-style-type: none"> • OFF • ON • DYNAMIC ²⁾ <ul style="list-style-type: none"> • OFF • MANUAL • LEVEL <ul style="list-style-type: none"> • SET1...SET60 • SEMI <ul style="list-style-type: none"> • LEVEL <ul style="list-style-type: none"> • SET1...SET60 • AUTO <ul style="list-style-type: none"> • LEVEL <ul style="list-style-type: none"> • SET1...SET60 • CHECK WEIGH ²⁾ <ul style="list-style-type: none"> • OFF • WEIGH • PCS • END MODE 	<ul style="list-style-type: none"> • RESET <ul style="list-style-type: none"> • NO • YES • KILOGRAM ²⁾ <ul style="list-style-type: none"> • OFF • ON • POUND ²⁾ <ul style="list-style-type: none"> • OFF • ON • GRAM ²⁾ <ul style="list-style-type: none"> • OFF • ON • POUND OUNCE ²⁾ <ul style="list-style-type: none"> • OFF • ON • TONNE ²⁾ <ul style="list-style-type: none"> • OFF • ON • OUNCE ²⁾ <ul style="list-style-type: none"> • OFF • ON • CUSTOM ²⁾ <ul style="list-style-type: none"> • OFF • 0.00001...9.99999 • EXPONENT <ul style="list-style-type: none"> • 0 • 1 • 2 • 3 • -2 • -1 • LSD <ul style="list-style-type: none"> • 0.00001...1000 • END UNIT 	<ul style="list-style-type: none"> • RESET <ul style="list-style-type: none"> • NO • YES • DATE <ul style="list-style-type: none"> • DATE TYPE <ul style="list-style-type: none"> • MDY • DMY • YMD • DATE SET <ul style="list-style-type: none"> • XX.XX.XX • TIME <ul style="list-style-type: none"> • TIME TYPE <ul style="list-style-type: none"> • 24 HR • 12 HR • TIME SET <ul style="list-style-type: none"> • XX:XX • USER ID <ul style="list-style-type: none"> • XXXXXX • PROJECT ID <ul style="list-style-type: none"> • XXXXXX • SCALE ID <ul style="list-style-type: none"> • XXXXXX • END GMP 	<ul style="list-style-type: none"> • RESET <ul style="list-style-type: none"> • NO • YES • STABLE PRINT ²⁾ <ul style="list-style-type: none"> • OFF • ON • AUTO PRINT <ul style="list-style-type: none"> • OFF • ON • ON STABLE <ul style="list-style-type: none"> • LOAD • LOAD AND ZERO • INTERVAL <ul style="list-style-type: none"> • 1...3600 • ACCEPT • CONTINUOUS • CONTENT <ul style="list-style-type: none"> • RESULT <ul style="list-style-type: none"> • OFF • ON • NUMERIC ONLY • GROSS <ul style="list-style-type: none"> • OFF • ON • NET <ul style="list-style-type: none"> • OFF • ON • TARE <ul style="list-style-type: none"> • OFF • ON • HEADER <ul style="list-style-type: none"> • OFF • ON • USER ID <ul style="list-style-type: none"> • OFF • ON • PROJECT ID <ul style="list-style-type: none"> • OFF • ON • SCALE ID <ul style="list-style-type: none"> • OFF • ON • DATE TIME <ul style="list-style-type: none"> • OFF • ON • SCALE NO <ul style="list-style-type: none"> • OFF • ON • DIFFERENCE <ul style="list-style-type: none"> • OFF • ON • INFORMATION <ul style="list-style-type: none"> • OFF • ON • MODE <ul style="list-style-type: none"> • OFF • ON • NAME <ul style="list-style-type: none"> • OFF • ON • ALIBI ID ³⁾ <ul style="list-style-type: none"> • OFF • ON • LIBRARY ID <ul style="list-style-type: none"> • OFF • ON • LIBRARY NAME <ul style="list-style-type: none"> • OFF • ON • LAYOUT <ul style="list-style-type: none"> • FORMAT <ul style="list-style-type: none"> • SINGLE • MULTI • FEED <ul style="list-style-type: none"> • NONE • LINE • 4 LINE • FORM • LIST <ul style="list-style-type: none"> • MENU • ALIBI ³⁾ • LIBRARY ⁴⁾ • END PRINT1

Notes:

- 1) Hidden when LEGAL FOR TRADE is ON.
- 2) Locked at current setting when LEGAL FOR TRADE is ON.
- 3) Visible only with Alibi option installed and ON.
- 4) Visible only with Library option ON.

PRINT2	COM1	COM2	I-O	LOCK MENU	LOCK KEY	END
<ul style="list-style-type: none"> • RESET • NO • YES • STABLE PRINT ²⁾ • OFF • ON • AUTO PRINT • OFF • ON STABLE <ul style="list-style-type: none"> • LOAD • LOAD AND ZERO • INTERVAL <ul style="list-style-type: none"> • 1...3600 • ACCEPT • CONTINUOUS • CONTENT • RESULT <ul style="list-style-type: none"> • OFF • ON • NUMERIC ONLY • GROSS <ul style="list-style-type: none"> • OFF • ON • NET <ul style="list-style-type: none"> • OFF • ON • TARE <ul style="list-style-type: none"> • OFF • ON • HEADER <ul style="list-style-type: none"> • OFF • ON • USER ID <ul style="list-style-type: none"> • OFF • ON • PROJECT ID <ul style="list-style-type: none"> • OFF • ON • SCALE ID <ul style="list-style-type: none"> • OFF • ON • DATE TIME <ul style="list-style-type: none"> • OFF • ON • SCALE NO <ul style="list-style-type: none"> • OFF • ON • DIFFERENCE <ul style="list-style-type: none"> • OFF • ON • INFORMATION <ul style="list-style-type: none"> • OFF • ON • MODE <ul style="list-style-type: none"> • OFF • ON • NAME <ul style="list-style-type: none"> • OFF • ON • ALIBI ID ³⁾ <ul style="list-style-type: none"> • OFF • ON • LIBRARY ID <ul style="list-style-type: none"> • OFF • ON • LIBRARY NAME <ul style="list-style-type: none"> • OFF • ON • LAYOUT <ul style="list-style-type: none"> • FORMAT <ul style="list-style-type: none"> • SINGLE • MULTI • FEED <ul style="list-style-type: none"> • NONE • LINE <ul style="list-style-type: none"> • 4 LINE • FORM • LIST <ul style="list-style-type: none"> • MENU • ALIBI ³⁾ • LIBRARY ⁴⁾ • END PRINT2 	<ul style="list-style-type: none"> • RESET • NO • YES • BAUD <ul style="list-style-type: none"> • 300 • 600 • 1200 • 2400 • 4800 • 9600 • 19200 • PARITY <ul style="list-style-type: none"> • 7 EVEN • 7 ODD • 7 NONE • 8 NONE • STOP <ul style="list-style-type: none"> • 1 • 2 • HANDSHAKE <ul style="list-style-type: none"> • NONE • XON-XOFF • HARDWARE • ALT. COMMAND <ul style="list-style-type: none"> • PRINT <ul style="list-style-type: none"> • A...Z • TARE <ul style="list-style-type: none"> • A...Z • ZERO <ul style="list-style-type: none"> • A...Z • END COM1 	<ul style="list-style-type: none"> • RESET • NO • YES • BAUD <ul style="list-style-type: none"> • 300 • 600 • 1200 • 2400 • 4800 • 9600 • 19200 • PARITY <ul style="list-style-type: none"> • 7 EVEN • 7 ODD • 7 NONE • 8 NONE • STOP <ul style="list-style-type: none"> • 1 • 2 • ADDRESS ⁵⁾ <ul style="list-style-type: none"> • OFF • 01 TO 99 • HANDSHAKE <ul style="list-style-type: none"> • NONE • XON-XOFF • ALT. COMMAND <ul style="list-style-type: none"> • PRINT <ul style="list-style-type: none"> • A...Z • TARE <ul style="list-style-type: none"> • A...Z • ZERO <ul style="list-style-type: none"> • A...Z • END COM2 	<ul style="list-style-type: none"> • RESET • NO • YES • EXT. INPUT <ul style="list-style-type: none"> • OFF • TARE • ZERO • PRINT • FUNCTION • START-STOP • TARE-START-STOP • INPUT BEEP <ul style="list-style-type: none"> • OFF • ON • RELAY OUTPUT <ul style="list-style-type: none"> • TYPE <ul style="list-style-type: none"> • OPEN • CLOSED • SEQUENCE <ul style="list-style-type: none"> • NORMAL • HOLD • CONTACT <ul style="list-style-type: none"> • SIMULTANEOUS • B-B-M • M-B-B • STABLE <ul style="list-style-type: none"> • OFF • ON • END I-O 	<ul style="list-style-type: none"> • RESET • NO • YES • LOCK CAL <ul style="list-style-type: none"> • OFF • ON • LOCK SETUP <ul style="list-style-type: none"> • OFF • ON • LOCK READOUT <ul style="list-style-type: none"> • OFF • ON • LOCK MODE <ul style="list-style-type: none"> • OFF • ON • LOCK UNIT <ul style="list-style-type: none"> • OFF • ON • LOCK PRINT1 <ul style="list-style-type: none"> • OFF • ON • LOCK PRINT2 <ul style="list-style-type: none"> • OFF • ON • LOCK COM1 <ul style="list-style-type: none"> • OFF • ON • LOCK COM2 <ul style="list-style-type: none"> • OFF • ON • LOCK GMP <ul style="list-style-type: none"> • OFF • ON • LOCK I-O <ul style="list-style-type: none"> • OFF • ON • END LOCK MENU 	<ul style="list-style-type: none"> • RESET • NO • YES • LOCK ALL <ul style="list-style-type: none"> • OFF • ON • LOCK OFF <ul style="list-style-type: none"> • OFF • ON • LOCK ZERO <ul style="list-style-type: none"> • OFF • ON • LOCK PRINT <ul style="list-style-type: none"> • OFF • ON • LOCK UNIT <ul style="list-style-type: none"> • OFF • ON • LOCK FUNCTION <ul style="list-style-type: none"> • OFF • ON • LOCK MODE <ul style="list-style-type: none"> • OFF • ON • LOCK TARE <ul style="list-style-type: none"> • OFF • ON • LOCK MENU <ul style="list-style-type: none"> • OFF • ON • LOCK LIBRARY <ul style="list-style-type: none"> • OFF • ON • LOCK INFO <ul style="list-style-type: none"> • OFF • ON • END LOCK KEY 	<ul style="list-style-type: none"> • END

Notes:

- 1) Hidden when LEGAL FOR TRADE is ON.
- 2) Locked at current setting when LEGAL FOR TRADE is ON.
- 3) Visible only with Alibi option installed and ON.
- 4) Visible only with Library option ON.
- 5) Visible only with RS485/RS422 option installed.

3.2 Menu Navigation

The following method is used to navigate the menu and change the settings.

Enter the menu by pressing and holding **Menu** until MENU is displayed.

- Press **No** to move to the next menu or press **Back** to move to the previous menu.
- Press **Yes** to enter the displayed menu.

After entering the desired menu,

- Press **No** to move to the next menu item or press **Back** to move to the previous menu item.
- Press **Yes** to enter the displayed menu item.

After entering the desired menu item,

- Press **No** to move to the next setting or press **Back** to move to the previous setting.
For menu items with numeric or alphanumeric settings, use the keypad to enter the desired value.
- Press **Yes** to accept the displayed setting.

Press **Exit** to immediately exit the menu at any time.

The example below shows how to change the language to SPANISH.

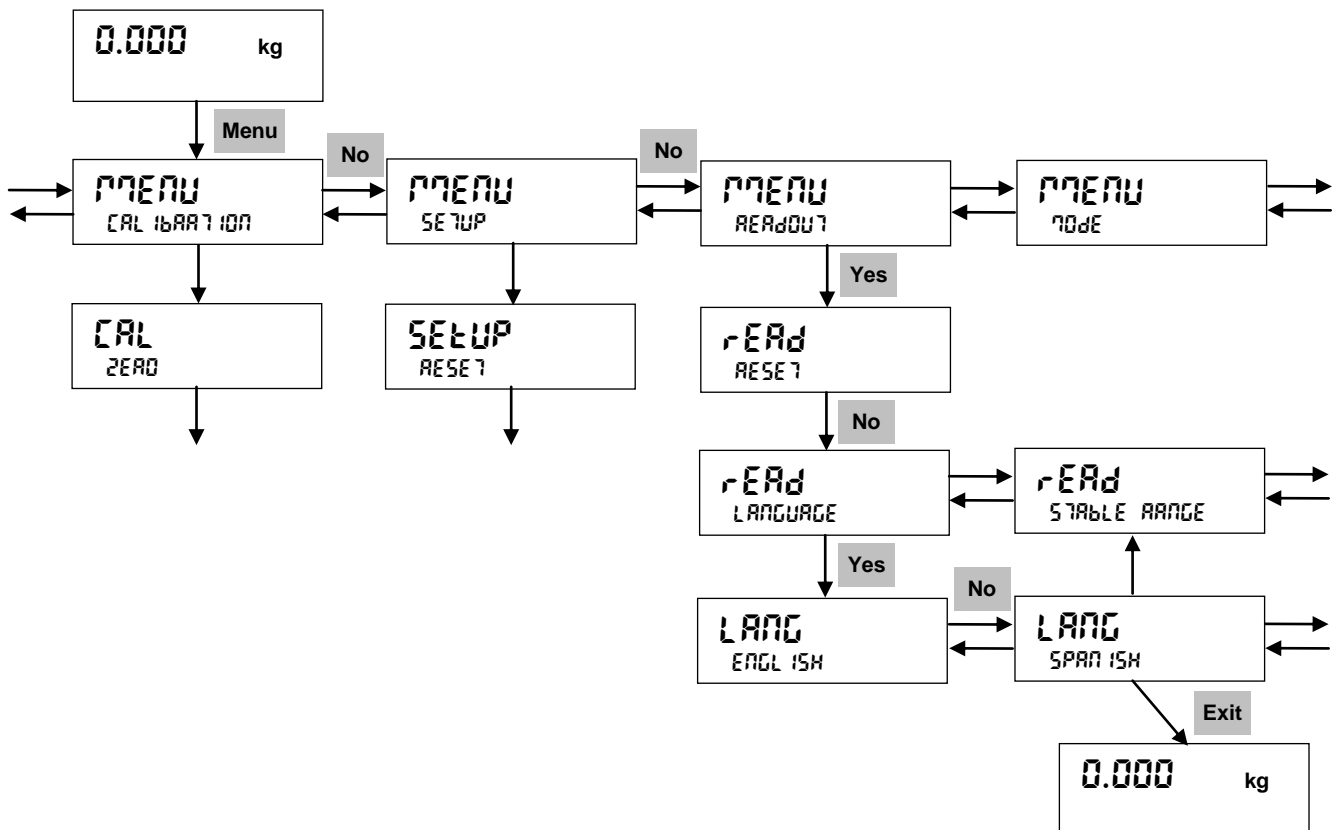

3.3 Calibration Menu

When CALIBRATION is displayed, press **Yes** to accept the Calibration menu. Press **No** to advance to the desired menu item.



NOTES: Before entering the Zero, Span, 3 Point Linearity or 5 Point Linearity menu items, remove all load from the scale.
 If DUAL SCALE is set to OFF, the ZERO, SPAN, 3PTLIN, 5PTLIN menu items are displayed.
 If DUAL SCALE is set to ON, the ZERO1, ZERO2, SPAN1, SPAN2, 3PTLIN1, 3PTLIN2, 5PTLIN1, 5PTLIN2 menu items are displayed, where the number represents the scale number.

3.3.1 Zero Calibration

Use this calibration method to adjust the zero calibration point, without affecting the span or linearity calibration.

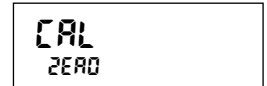

With no load on the scale, press **Yes** to set the new zero calibration point.

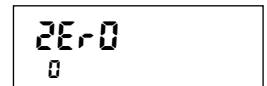

The display shows --C--, then DONE and returns to the current application mode.

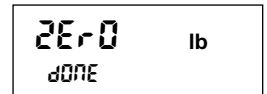
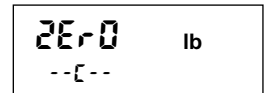

3.3.2 Span Calibration

Use this calibration method to adjust the zero calibration point and span calibration point, without affecting the linearity calibration.

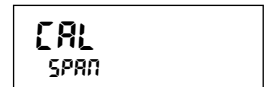

With no load on the scale, press **Yes**. The display shows the current span calibration point and calibration unit of measure.

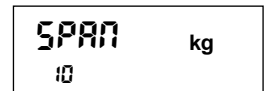

NOTES: To change the span calibration point, press **No** and enter the value using the keypad. Then press **Yes**.
 To change the calibration unit of measure, press **No** to alternate between kg and lb.

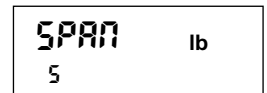
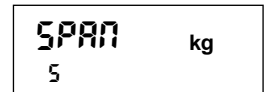

Place the specified calibration weight on the scale and press **Yes**. The display shows --C--, followed by the zero calibration point.

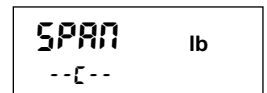

With no load on the scale, press **Yes**.

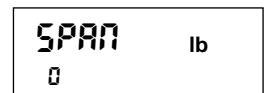

The display shows --C--, then DONE and returns to the current application mode.

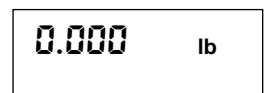
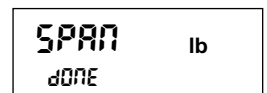
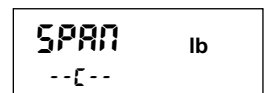

3.3.3 3 Point Linearity Calibration

Use this calibration method to adjust the zero calibration point, 1/2 and full load calibration points.

With no load on the scale, press **Yes**. The display shows the current full load calibration point and calibration unit of measure.

NOTES: To change the full load calibration point, press **No** and enter the value using the keypad. Then press **Yes**.
To change the calibration unit of measure, press **No** to alternate between kg and lb.

Place the specified full load calibration weight on the scale and press **Yes**. The display shows --C--, followed by the 1/2 load calibration point.

Place the specified 1/2 load calibration weight on the scale and press **Yes**. The display shows --C--, followed by the zero calibration point.

With no load on the scale, press **Yes**. The display shows --C--, then DONE and returns to the current application mode.

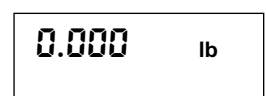
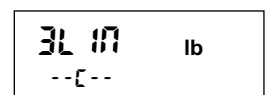
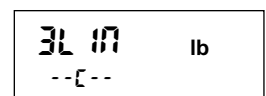
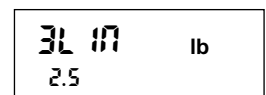
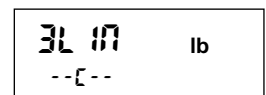
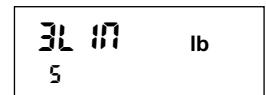
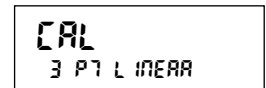

3.3.4 5 Point Linearity Calibration

Use this calibration method to adjust the zero calibration point, 1/4, 1/2, 3/4 and full load calibration points

With no load on the scale, press **Yes**. The display shows the current full load calibration point and calibration unit of measure.

NOTES: To change the full load calibration point, press **No** and enter the value using the keypad. Then press **Yes**.
To change the calibration unit of measure, press **No** to alternate between kg and lb.

Place the specified full load calibration weight on the scale and press **Yes**. The display shows --C--, followed by the 3/4 load calibration point.

Place the specified 3/4 load calibration weight on the scale and press **Yes**. The display shows --C--, followed by the 1/2 load calibration point.

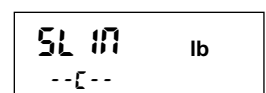
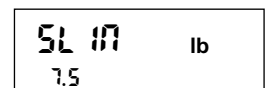
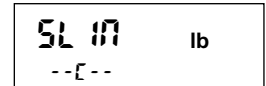
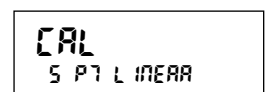

Place the specified 1/2 load calibration weight on the scale and press **Yes**. The display shows --C--, followed by the 1/4 load calibration point.

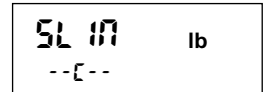
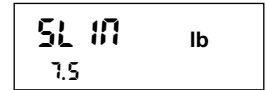

Place the specified 1/4 load calibration weight on the scale and press **Yes**. The display shows --C--, followed by the zero calibration point.

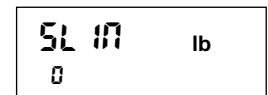

With no load on the scale, press **Yes**. The display shows --C--, then DONE and returns to the current application mode.

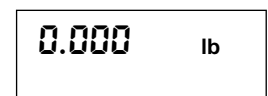
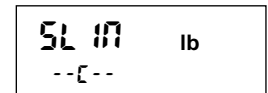

3.3.5 Calibration Test

Calibration Test is used to compare a known calibration weight against the stored span calibration data.

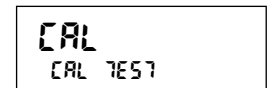

With no load on the scale, press **Yes**. The display shows the zero load calibration point.



With no load on the scale, press **Yes**. The display shows --T--, followed by the full load calibration point.



Place the specified full load calibration weight on the scale and press **Yes**. The display shows --T--, followed by difference between the calibration weight and the stored calibration data.

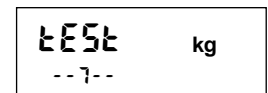

After 5 seconds, the display returns to the current application mode.



3.3.6 Geographical Adjustment Factor

Geographical Adjustment Factor (GEO) is used to adjust the calibration based on the current location. Refer to Section 6, Table 6-1 and set the GEO factor that corresponds to your location.

Settings from 1 to 31 are available.

Press the **No** or **Back** button to change the value. Press **Yes** to accept the value.

NOTE: Only an authorized manufacturer’s representative or certified verification personnel may make these changes. Changing the geographical setting alters the calibration values.

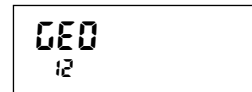
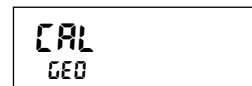

3.3.7 End Calibration

Press **Yes** to advance to the next menu or **No** to return to the top of the current menu.

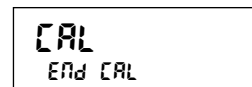

3.4 Setup Menu

When the indicator is used for the first time, enter this menu to set the Range, Capacity and Graduation values. If the indicator comes as part of a bench scale, these values were already set in the factory.



NOTE: If two scales will be operated, set DUAL SCALE to ON and set the Range, Capacity and Graduation values for both scales. The Range1, Capacity1 and Graduation1 values are set for Scale 1, which is connected to the circular connector (Figure 1-1, Item 8) or terminal block J4 (Figure 1-3, Item 9) on the main pc board. The Range2, Capacity2, and Graduation2 values are set for Scale 2, which is connected to the terminal block J7 (Figure 1-3, Item 5) on the main pc board. All other Setup Menu settings apply to both scales.

3.4.1 Reset

Reset the Setup menu to the factory defaults. Factory default settings are shown in bold.

NO = not reset
YES = reset

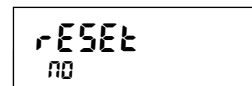
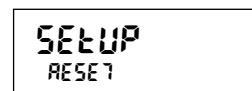

3.4.2 Dual Scale

Set the status of the second scale input (Scale 2).

OFF = Scale 2 is not active.
ON = Scale 2 is active.

NOTES: If DUAL SCALE is set to OFF, the RANGE, CAPACITY and GRADUATION menu items are displayed.
 If DUAL SCALE is set to ON, the RANGE1, RANGE2, CAPACITY1, CAPACITY2, GRADUATION1 and GRADUATION2 menu items are displayed, where the number represents the scale number.

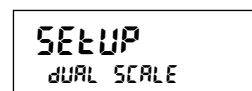

3.4.3 Range1

Set the number of weighing ranges for Scale 1.

SINGLE = one weighing range from zero to capacity.
DUAL = two weighing ranges. The fine range (1 \pm) is from zero to half capacity. The coarse range (2 \pm) is from half capacity to full capacity.

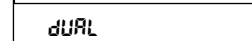
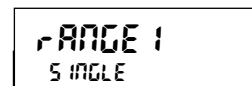

NOTE: If DUAL SCALE is set to OFF, RANGE is displayed instead of RANGE1.

3.4.4 Range2

Set the number of weighing ranges for Scale 2.

- SINGLE** = one weighing range from zero to capacity.
DUAL = two weighing ranges.
 The fine range (r1) is from zero to half capacity.
 The coarse range (r2) is from half capacity to full capacity.

3.4.5 Capacity1

Set the capacity of Scale 1 using the numeric keypad.

Settings from **1** to 999999 are available.

NOTE: if DUAL SCALE is set to OFF, CAPACITY is displayed instead of CAPACITY1.

NOTE: If DUAL was selected as the Range1 setting, the Capacity1 setting defines the capacity of the coarse range. The capacity of the fine range is automatically defined as half of the Capacity1 setting. For example, if the Capacity1 setting is 15, the capacity of the fine range is 7.5 and the capacity of the coarse range is 15.

After the capacity is set, select the primary unit.

- kg** = the primary unit is kilograms.
lb = the primary unit is pounds.

3.4.6 Capacity2

Set the capacity of Scale 2 using the numeric keypad.

Settings from **1** to 999999 are available.

NOTE: If DUAL was selected as the Range2 setting, the Capacity2 setting defines the capacity of the coarse range. The capacity of the fine range is automatically defined as half of the Capacity2 setting.

After the capacity is set, select the primary unit.

- KILOGRAM** = the primary unit is kilograms.
POUND = the primary unit is pounds.

3.4.7 Graduation1

Set the readability of Scale 1.

Settings of 0.0001, 0.0002, 0.0005, **0.001**, 0.002, 0.005, 0.01, 0.02, 0.05, 0.1, 0.2, 0.5, 1, 2, 5, 10, 20, 50, and 100 are available.

NOTE: If DUAL SCALE is set to OFF, GRADUATION is displayed instead of GRADUATION1.

NOTE: Graduation1 setting selections are dependent on the Capacity1 setting. Selections are limited to values that will provide a scale resolution between 1:1000 and 1:50000.

NOTE: If DUAL was selected as the Range1 setting, the Graduation1 setting defines the fine range graduation. The coarse range graduation is automatically defined as one step greater than the Graduation1 setting. For example, if Graduation1 is set to 0.001, the coarse range graduation is defined as 0.002.

3.4.8 Graduation2

Set the readability of Scale 2.

Settings of 0.0001, 0.0002, 0.0005, 0.001, 0.002, 0.005, 0.01, 0.02, 0.05, 0.1, 0.2, 0.5, 1, 2, 5, 10, 20, 50, and 100 are available.

NOTE: Graduation2 setting selections are dependent on the Capacity2 setting. Selections are limited to values that will provide a scale resolution between 1:1000 and 1:50000.

NOTE: If DUAL was selected as the Range1 setting, the Graduation2 setting defines the fine range graduation. The coarse range graduation is automatically defined as one step greater than the Graduation2 setting.

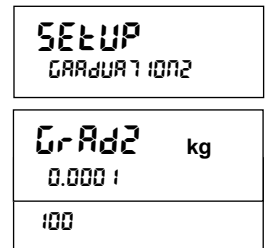

3.4.9 Power Unit

Set the unit of measure displayed at startup.

- AUTO** = last unit in use when the indicator was turned off.
- KILOGRAM** = kilograms
- GRAM** = grams
- POUND** = pounds
- OUNCE** = ounces
- POUND OUNCE** = pound ounces
- TONNE** = tonnes
- CUSTOM** = custom unit

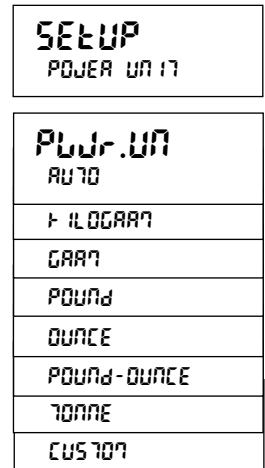

3.4.10 Zero Range

Set the percentage of scale capacity that may be zeroed.

- 2%** = zero up to 2 percent of capacity.
- 100%** = zero up to 100 percent of capacity.

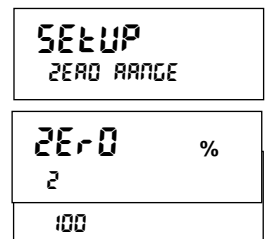

3.4.11 Auto Tare

Set the automatic tare functionality.

- OFF** = automatic tare is disabled.
- ON** = the first stable gross weight is tared.
- ACCEPT** = in Check weighing mode, stable gross loads within the accept limits are tared.



When ACCEPT is selected, set the delay time.

- OFF** = automatic tare takes affect as soon as the weight is stable.
- 0.5** = automatic tare takes affect after the weight is stable for 0.5 second.
- 1** = automatic tare takes affect after the weight is stable for 1 second.
- 2** = automatic tare takes affect after the weight is stable for 2 seconds.
- 5** = automatic tare takes affect after the weight is stable for 5 seconds.

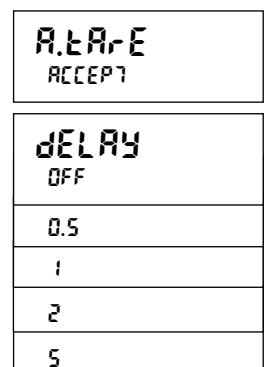

3.4.12 Accumulate

Set the accumulate functionality.

OFF	= accumulation is disabled.
MANUAL	= the displayed value is manually added to the total by pressing the FUNCTION button.
AUTO	= the displayed value is automatically added to the total when the display becomes stable.

```

SETUP
ACCUMULATE
  
```

```

ACCUM
OFF
MANUAL
AUTO
  
```

3.4.13 Retain Zero

Set the Retain Zero functionality.

OFF	= Retain Zero is disabled.
ON	= when power is turned on, the displayed weight is based on the last stored zero (Zero button or "Z" command).

```

SETUP
RETAIN ZERO
  
```

```

RETAIN
OFF
ON
  
```

3.4.14 Legal For Trade

Set the legal for trade status.

OFF	= standard operation.
ON	= operation complies with weights and measures regulations.

```

SETUP
LEGAL TRADE
  
```

```

LFT
OFF
ON
  
```

NOTE: When Legal for Trade is set to ON, the Menu settings are affected as follows:

- Calibration functions are hidden except for Calibration Test.
- Capacity is read-only.
- Range, Graduation, Power On unit, Auto-Tare, Retain Zero, Gross Indication, Print Output, Unit and Mode settings are locked at their current settings.
- Zero Range is locked at 2%.
- Stable Range is locked at 1d.
- Auto-Zero Tracking is set to 0.5d.
- Continuous Print is disabled.
- IP and CP RS232 commands are disabled.

3.4.15 Beep Volume

Set the beeper volume.

OFF	= the beeper is disabled.
LOW	= the beeper volume is soft.
HIGH	= the beeper volume is loud.

```

SETUP
BEEP VOLUME
  
```

```

BP.VOL
OFF
LOW
HIGH
  
```

3.4.16 Beep Signal

Set how the beeper responds in Check Weighing mode.

OFF	= the beeper is disabled.
ACCEPT	= the beeper sounds when the weight is within the accept range.
UNDER	= the beeper sounds when the weight is below the Under setting.
OVER	= the beeper sounds when the weight is above the Over setting.
UNDER-OVER	= the beeper sounds when the weight is below the Under setting or above the Over setting.

```

SETUP
BEEP SIGNAL
  
```

```

BP.SIG
OFF
ACCEPT
UNDER
OVER
UNDER-OVER
  
```

3.4.17 Key Beep

Set whether the beeper sounds when a button is pressed.

- OFF = no sound
- ON = sound

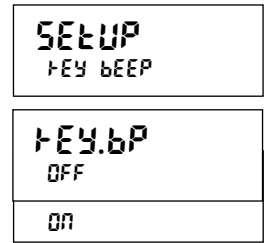

3.4.18 Library

Set whether the library memory is enabled.

- OFF = data cannot be stored in the library memory.
- ON = data can be stored in the library memory.

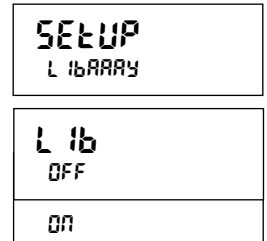

3.4.19 Alibi

Set whether the alibi memory is enabled.

- OFF = alibi records are not stored in the alibi memory.
- ON = alibi records are stored in the alibi memory.

NOTE: The Alibi menu item is only displayed if the Alibi Memory Option is installed.

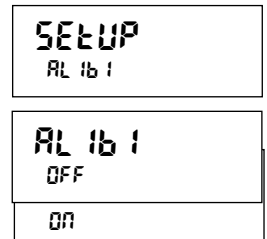

3.4.20 End Setup

Advance to the next menu or return to the top of the current menu.



3.5 Readout Menu

Enter this menu to customize display functionality.

3.5.1 Reset

Reset the Readout menu to the factory defaults. Factory default settings are shown in bold.

- NO = not reset
- YES = reset

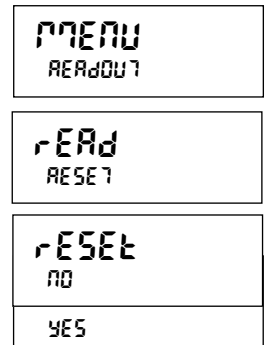

3.5.2 Language

Set the language for menus and displayed messages.

- ENGLISH = English
- SPANISH = Spanish
- FRENCH = French
- GERMAN = German
- ITALIAN = Italian



3.5.3 Stable Range

Set the amount the reading can vary while the stability symbol remains on.

- 0.5 d = 0.5 graduations
- 1 d** = 1 graduation
- 2 d = 2 graduations
- 3 d = 3 graduations
- 5 d = 5 graduations

NOTE: When LEGAL FOR TRADE is set to ON, the setting is forced to 1 d. The setting is locked when the Security Switch is set to the ON position.

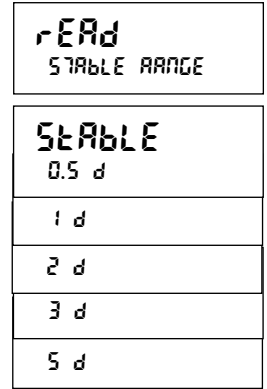

3.5.4 Filter

Set the amount of signal filtering.

- LOW = faster stabilization time with less stability.
- MEDIUM** = normal stabilization time with normal stability.
- HIGH = slower stabilization time with more stability.

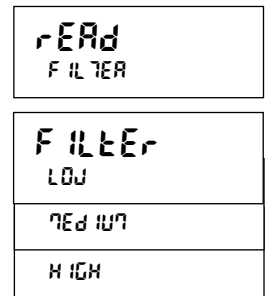

3.5.5 Auto Zero Tracking

Set the automatic zero tracking functionality.

- OFF = disabled.
- 0.5 D** = the display maintains zero until a drift of 0.5 graduation per second is exceeded.
- 1 D = the display maintains zero until a drift of 1 graduation per second is exceeded.
- 3 D = the display maintains zero until a drift of 3 graduations per second is exceeded.

NOTE: When Legal for Trade is set to ON, the setting is forced to 0.5 D. The 1 D and 3 D settings are still available for applications that permit these settings. The setting is locked at the current setting when the security switch is set to the ON position.

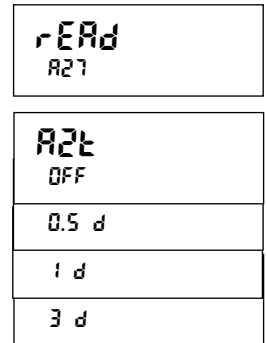

3.5.6 Backlight

Set the display backlight functionality.

- OFF = the backlight is always off.
- ON = the backlight is always on.
- AUTO** = the backlight turns on when a button is pressed, or the displayed weight changes and it turns off after the specified time period.

When AUTO is selected, set the time period.

- 1 MINUTE** = the backlight turns off after 1 minute.
- 2 MINUTES = the backlight turns off after 2 minutes.
- 5 MINUTES = the backlight turns off after 5 minutes.

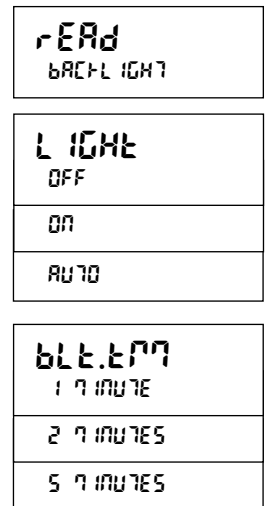

3.5.7 Auto Off Timer

Set the automatic shut off functionality.

- OFF** = disabled.
- 1 MINUTE = the indicator turns off after 1 minute of inactivity.
- 2 MINUTES = the indicator turns off after 2 minutes of inactivity.
- 5 MINUTES = the indicator turns off after 5 minutes of inactivity.

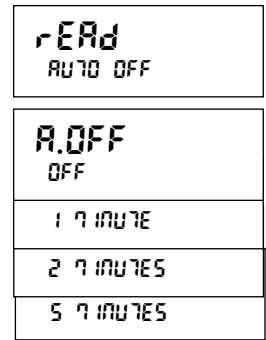

3.5.8 Gross Indicator

Set the symbol displayed for gross weights.

- OFF** = no symbol is displayed.
- GROSS = the G symbol is displayed.
- BRUTTO = the B symbol is displayed.

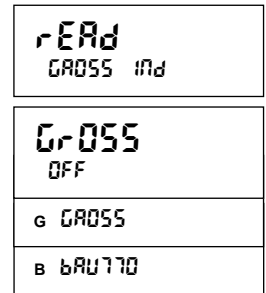

3.5.9 End Readout

Advance to the next menu or return to the top of the current menu.



3.6 Mode Menu

Enter this menu to activate the desired application modes.

3.6.1 Reset

Reset the Mode menu to the factory defaults. Factory default settings are shown in bold.

- NO = not reset
- YES = reset

NOTE: When LEGAL FOR TRADE is set to ON, the Mode menu cannot be reset.

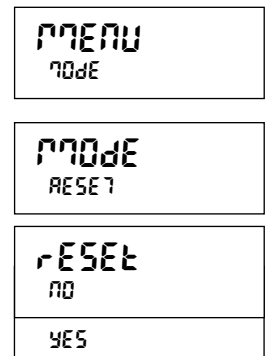

3.6.2 Weighing Mode

Set the status.

- OFF = disabled
- ON** = enabled

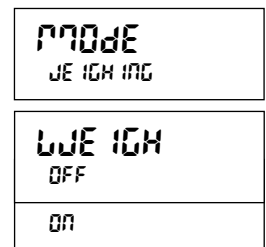

3.6.3 Parts Counting Mode

Set the status.

- OFF = disabled
- ON** = enabled

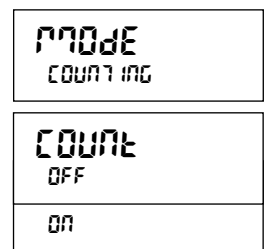

3.6.4 Parts Counting Optimization

When the Parts Counting mode is turned ON, Parts Counting Optimization can be used to automatically adjust the average piece weight (APW). Each time a quantity greater than 1x or less than 3x the previous quantity is placed on the scale, the APW is adjusted.

OFF = disabled
ON = enabled

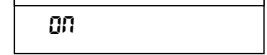
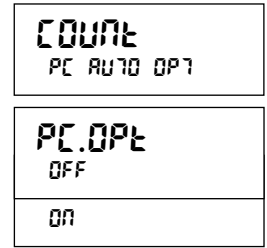

3.6.5 Percent Weighing Mode

Set the status.

OFF = disabled
ON = enabled

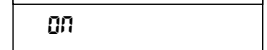
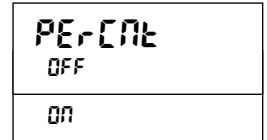

3.6.6 Dynamic Weighing Mode

Set the status.

OFF = disabled
MANUAL = averaging and resetting are manually initiated by pressing **FUNCTION**.
SEMI AUTO = averaging is automatically initiated when the display exceeds 5 graduations; resetting is manually initiated by pressing **FUNCTION**.
AUTO = averaging is automatically initiated when the display exceeds 5 graduations; resetting is automatically initiated when the display returns to within 5 graduations of zero.

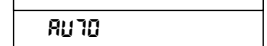
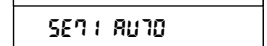
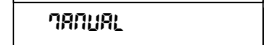
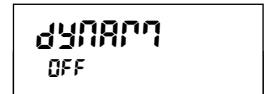

If MANUAL, SEMI AUTO, or AUTO is selected, the current averaging time is displayed.

Set the averaging time.

Settings of 0 to 60 seconds are available.

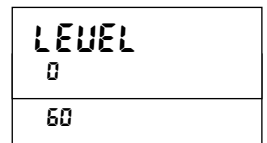

NOTE: Select 0 seconds to enable the **Display Hold** function. In this case, the first stable weight will be held on the display.

3.6.7 Check Weighing Mode

Set the status.

OFF = disabled
WEIGH = enabled for checking items by weight.
PCS = enabled for checking items by count.

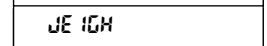
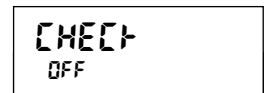
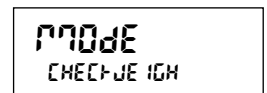

3.6.8 End Mode

Advance to the next menu or return to the top of the current menu.



3.7 Unit Menu

Enter this menu to activate the desired units of measure.

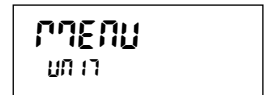

NOTE: Due to national laws, the indicator may not include some of the units of measure listed.

3.7.1 Reset

Reset the Unit menu to the factory defaults. Factory default settings are shown in bold.

- NO** = not reset
- YES** = reset

NOTE: If LEGAL FOR TRADE is set to ON, the Unit menu is not reset.

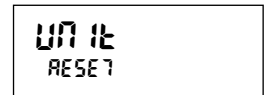

3.7.2 Kilogram Unit

Set the status.

- OFF** = disabled
- ON** = enabled

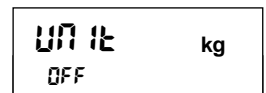
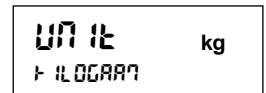

3.7.3 Pound Unit

Set the status.

- OFF** = disabled
- ON** = enabled

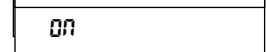
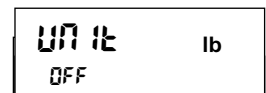
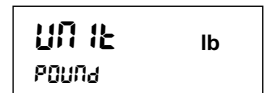

3.7.4 Gram Unit

Set the status.

- OFF** = disabled
- ON** = enabled

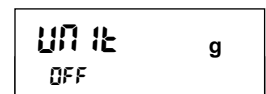
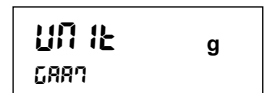

3.7.5 Ounce Unit

Set the status.

- OFF** = disabled
- ON** = enabled

NOTE: Ounce Unit is not available when Range is set to DUAL.

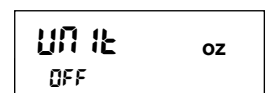

3.7.6 Pound Ounce Unit

Set the status.

- OFF** = disabled
- ON** = enabled

NOTE: Pound Ounce Unit is not available when Range is set to DUAL or when Graduation setting is greater than 0.01 kilograms or 0.02 pounds.

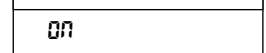
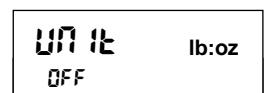
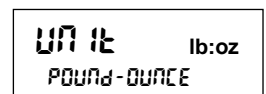

3.7.7 Tonne Unit

Set the status.

- OFF** = disabled
- ON** = enabled

NOTE: Tonne Unit is not available when Range is set to DUAL or when Graduation setting is less than 0.01 kilograms or 0.02 pounds.



3.7.8 Custom Unit

Use Custom Unit to display weight in an alternative unit of measure. The custom unit is defined using a conversion factor, where the conversion factor is the number of custom units per kilogram expressed in scientific notation (Factor x 10^Exponent).

For example: To display weight in troy ounces (32.15075 troy ounces per kilogram) enter a Factor of 3.21508 and an Exponent of 1.

Set the status.

- OFF** = disabled
- ON** = enabled

NOTE: Custom Unit is not available when Range is set to DUAL.

When Custom Unit is set to ON, the Factor, Exponent and Least Significant Digit must be set.

Factor

Set the conversion factor using the numeric keypad.

Settings of 0.00001 to 9.99999 are available. The default setting is **1.00000**.



Exponent

Set the factor multiplier.

- 0** = multiply the Factor by 1 (1x10⁰)
- 1** = multiply the Factor by 10 (1x10¹)
- 2** = multiply the Factor by 100 (1x10²)
- 3** = multiply the Factor by 1000 (1x10³)
- 2** = divide the Factor by 100 (1x10⁻²)
- 1** = divide the Factor by 10 (1x10⁻¹)

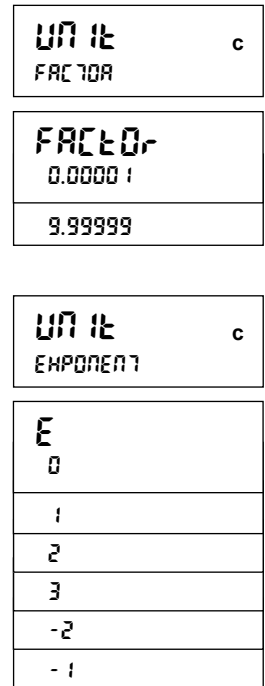

Least Significant Digit

Set the graduation.

Settings of 0.00001, 0.00002, 0.00005, 0.0001, 0.0002, 0.0005, **0.001**, 0.002, 0.005, 0.01, 0.02, 0.05, 0.1, 0.2, 0.5, 1, 2, 5, 10, 20, 50, 100, 200, 500 and 1000 are available.

NOTE: Least Significant Digit setting selections are dependent on the Factor and Exponent settings. Selections are limited to values that will provide a scale resolution between 1:1000 and 1:50000.

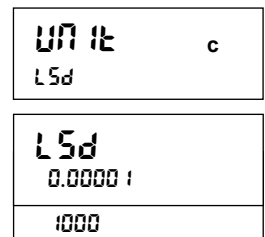

3.7.9 End Unit

Advance to the next menu or return to the top of the current menu.

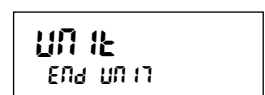

3.8 GMP Menu

Enter this menu to set the Good Manufacturing Practices data.

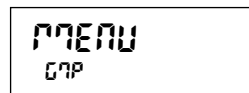

3.8.1 Reset

Reset the GMP menu to the factory defaults. Factory default settings are shown in bold.

NO = not reset
YES = reset

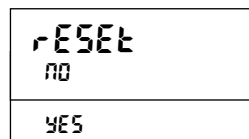
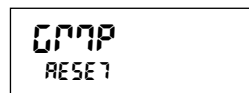

3.8.2 Date

Enter this menu to set the date.

Date Type

Set the date format.

MDY = Month.Day.Year
DMY = Day.Month.Year
YMD = Year.Month.Day

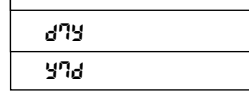
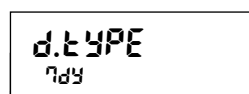
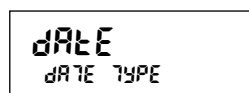
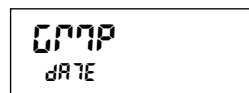

Date Set

Set the date.

00 to 99 = year position
 01 to 12 = month position
 01 to 31 = day position

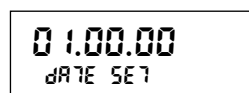
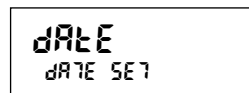

3.8.3 Time

Enter this menu to set the time.

Time Type

Set the time format.

24 HOUR = 24 hour format
12 HOUR = 12 hour format

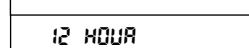
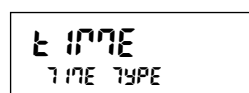

Time Set

Set the time.

24 hour format:
 00 to 23 = hour position
 00 to 59 = minute position

12 hour format:
 01 to 12 = hour position
 00 to 59 = minute position
 A or P = am or pm position

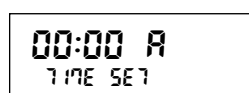
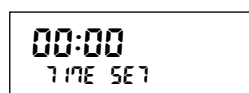
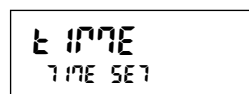

3.8.4 User ID

Set the user identification.

Alphanumeric settings up to 12 characters are available. The default setting is **000000**.

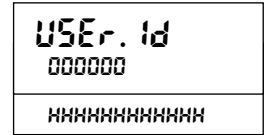
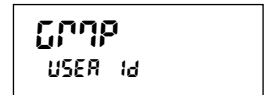

3.8.5 Project ID

Set the project identification.

Alphanumeric settings up to 12 characters are available. The default setting is **000000**.

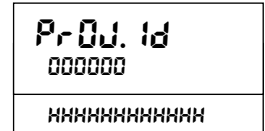

3.8.6 Scale ID

Set the scale identification.

Alphanumeric settings up to 12 characters are available. The default setting is **000000**.

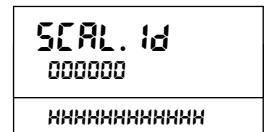
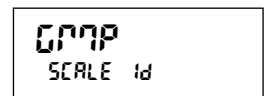

3.8.7 End GMP

Advance to the next menu or return to the top of the current menu.

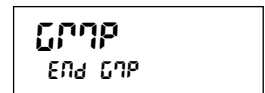

3.9 Print1, Print2 Menus

Enter this menu to set printing parameters.

NOTE: The Print2 menu is only available if the optional RS232 or RS485/RS422 interface is installed.



3.9.1 Reset

Reset the Print menu to the factory defaults. Factory default settings are shown in bold.

- NO = not reset
- YES = reset

NOTE: If LEGAL FOR TRADE is set to ON, the Stable setting is not reset.

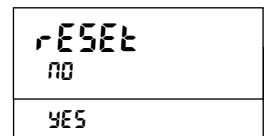
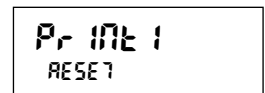

3.9.2 Print Stable Data Only

Set the printing criteria.

- OFF** = values are printed immediately, regardless of stability.
- ON** = values are printed only when the stability criteria are met.

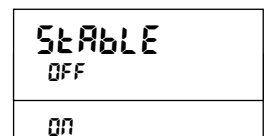
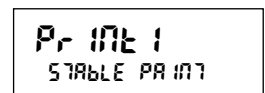

3.9.3 Auto Print

Set the automatic printing functionality.

- OFF** = disabled
- ON STABLE** = printing occurs each time the stability criteria are met.
- INTERVAL** = printing occurs at the defined time interval.
- ACCEPT** = in Checkweigh mode, printing occurs each time the display is within the accept range and the stability criteria are met.
- CONTINUOUS** = printing occurs continuously.

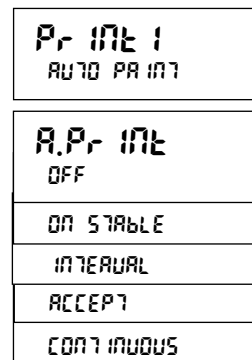

When ON STABLE is selected, set the conditions for printing.

- LOAD** = Prints when the displayed load is stable.
- LOAD ZERO** = Prints when the displayed load or zero reading is stable.

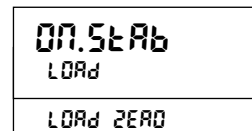

When INTERVAL is selected, set the time interval using the numeric keypad.

Settings of 1 to 3600 seconds are available.



3.9.4 Print Content Sub-menu

Enter this sub-menu to define the content of the printed data.

Result

Set the status.

- OFF** = the displayed reading is not printed.
- ON** = the displayed reading is printed.
- NUMERIC ONLY** = only the numeric portion of the displayed reading is printed.

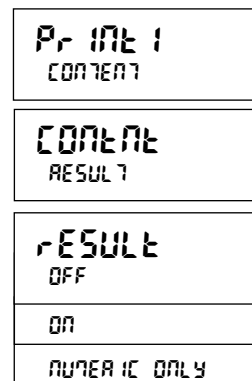
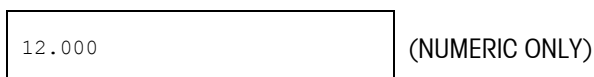

Gross

Set the status.

- OFF** = the gross weight is not printed.
- ON** = the gross weight is printed.

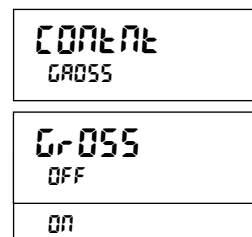
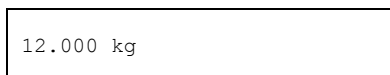

Net

Set the status.

- OFF** = the net weight is not printed.
- ON** = the net weight is printed.

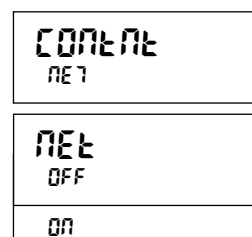
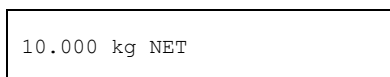

Tare

Set the status.

- OFF** = the tare weight is not printed.
- ON** = the tare weight is printed.

2.000 kg T

CONTENT
TARE

TARE
OFF

ON

Header

Set the status.

- OFF** = the user defined header is not printed.
- ON** = the user defined header is printed.

USER DEFINED TEXT
USER DEFINED TEXT
USER DEFINED TEXT
USER DEFINED TEXT
USER DEFINED TEXT

CONTENT
HEADER

HEADER
OFF

ON

NOTE: The header information must be defined using the H x "text" interface command. Refer to Section 5.1.

User ID

Set the status.

- OFF** = the User ID value is not printed.
- ON** = the User ID value is printed.

User Id: XXXXXXXXXXXXX

CONTENT
USER ID

USER ID
OFF

ON

Project ID

Set the status.

- OFF** = the Project ID value is not printed.
- ON** = the Project ID value is printed.

Project Id: XXXXXXXXXXXXX

CONTENT
PROJECT ID

PROJ. ID
OFF

ON

Scale ID

Set the status.

- OFF** = the Scale ID value is not printed.
- ON** = the Scale ID value is printed.

Scale Id: XXXXXXXXXXXXX

CONTENT
SCALE ID

SCALE ID
OFF

ON

Date-Time

Set the status.

- OFF** = the time and date are not printed.
- ON** = the time and date are printed.

01/31/08 12:30 PM

CONTENT
DATE-TIME

DATE-TIME
OFF

ON

Scale Number

Set the status.

- OFF** = the Scale Number line is not printed.
- ON** = the Scale Number line is printed.

Scale No: X

CONFIRM
SCALE NO

SCALE NO
OFF
ON

Difference

Set the status.

- OFF** = the difference is not printed following the Calibration Test procedure.
- ON** = the difference is printed following the Calibration Test procedure.

```

----- Cal Test -----
New Cal: 10.000 kg
Old Cal: 9.999 kg
Diff: 0.001 kg
Wt. ID:-----
----- End -----
    
```

CONFIRM
DIFFERENCE

DIFF
OFF
ON

Information

Set the status.

- OFF** = the reference information is not printed.
- ON** = the reference information is printed.

NOTE: The reference information is dependent on the mode and the ACCUMULATE setting. Examples are shown below.

CONFIRM
INFORMATION

INFO
OFF
ON

Mode	Accumulate set OFF	Accumulate set ON
Weighing	None	N: 10 Total: 10.000 kg Avg: 1.000 kg Std: 0.001 kg Min: 0.999 kg Max: 1.001 kg Diff: 0.002 kg
Counting	APW: 0.100 kg	APW: 0.100 kg N: 10 Total: 1000 Pcs Avg: 100 Pcs Std: 1 Pcs Min: 99 Pcs Max: 101 Pcs Diff: 2 Pcs
Percent	Ref Wt: 1.23 kg	Ref Wt: 1.23 kg
Check Weighing	Under: 0.995 kg Over: 1.005 kg	Under: 0.995 kg Over: 1.005 kg N: 10 Total: 10.000 kg Avg: 1.000 kg Std: 0.001 kg Min: 0.999 kg Max: 1.001 kg Diff: 0.002 kg
Dynamic	Level: 0	Level: 0 N: 10 Total: 10.000 kg Avg: 1.000 kg Std: 0.001 kg

		Min: 0.999 kg Max: 1.001 kg Diff: 0.002 kg	
--	--	--	--

Mode

Set the status.

- OFF** = the current mode is not printed.
- ON** = the current mode is printed.

Mode: XXXXXX

CONTENT
MODE

MODE
OFF
ON

Name

Set the status.

- OFF** = the name line is not printed.
- ON** = the name line is printed.

Name: -----

CONTENT
NAME

NAME
OFF
ON

Alibi Record ID

Set the status.

- OFF** = the Alibi Record ID line is not printed.
- ON** = the Alibi Record ID is printed.

Alibi Record: XXXXXX

CONTENT
ALIBI ID

ALIBI
OFF
ON

NOTE: The Alibi Record ID menu item is only displayed when the Alibi option is installed.

Library ID

Set the status.

- OFF** = the Library ID line is not printed.
- ON** = the Library ID is printed.

Library Id: XXXXX

CONTENT
LIBRARY ID

LIB. ID
OFF
ON

NOTE: "Library Id: -----" is printed when Library Id is set ON, but a Library Record is not in use. This occurs under the following conditions:

- A Library Record is not loaded.
- The loaded Library Record is no longer in use, because a manually entered Tare, APW, Reference Weight, Under Limit, Over Limit or Level has replaced one of loaded values.
- The loaded Library Record is no longer in use, because the indicator was turned off.

Library Name

Set the status.

- OFF** = the Library Name line is not printed.
- ON** = the Library Name is printed.

Library Name: XXXXXX

CONTENT
LIBRARY NAME

LIB.NAME
OFF
ON

NOTE: "Library Id: -----" is printed when Library Id is set ON, but a Library Record is not in use. This occurs under the following conditions:

- A Library Record is not loaded.

- The loaded Library Record is no longer in use, because a manually entered Tare, APW, Reference Weight, Under Limit, Over Limit or Level has replaced one of loaded values.
- The loaded Library Record is no longer in use, because the indicator was turned off.

3.9.5 Layout Sub-menu

This sub-menu is used to define the format of the data output to a printer or computer.

Format

Set the printing format.

- MULTI** = a multiple line printout is generated. A CRLF is added after each data output.
- SINGLE** = a single line printout is generated. A TAB delimiter is added between each data output.

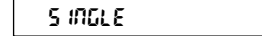
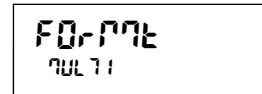
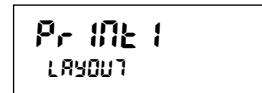

Feed

Set the paper feed.

- NONE** = the paper remains in its current position after printing.
- LINE** = move the paper up one line after printing.
- 4 LINE** = move the paper up four lines after printing.
- FORM** = a form feed is appended to the output.



3.9.6 List

Print the specified data.

- MENU** = print all menu settings.
- ALIBI** = print a range of alibi records stored in memory.
- LIBRARY** = print all library records stored in memory.

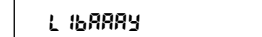
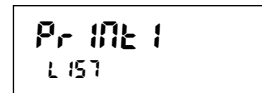

NOTE: The ALIBI selection is only available when the ALIBI Memory Option is installed.

When ALIBI is selected, set the range of Alibi records to be printed.

- START** = Enter the first record in the range. Settings from 1 to the last stored record number are available.
- END.** = Enter the last record in the range. Settings from the Start value to the last stored record number are available.

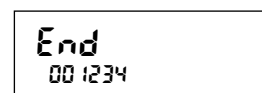
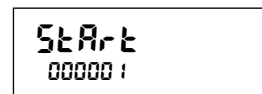

NOTE: To print all Alibi records, do not change the Start and End values. To print a single record, enter the same record number for the Start and End values.

3.9.7 End Print1, End Print2

Advance to the next menu or return to the top of the current menu.

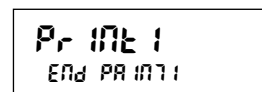

3.10 COM1, COM2 Menus

Enter this menu to define communication parameters.

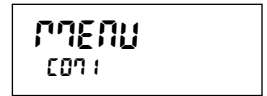

NOTE: The COM2 menu is only available if an optional RS232 PC Board or RS485/RS422 PC Board is installed.

3.10.1 Reset

Reset the COM menus to the factory defaults. Factory default settings are shown in bold.

- NO = not reset
- YES = reset

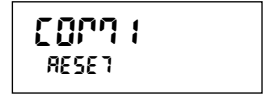

3.10.2 Baud

Set the baud rate.

- 300 = 300 bps
- 600 = 600 bps
- 1200 = 1200 bps
- 2400 = 2400 bps
- 4800 = 4800 bps
- 9600** = 9600 bps
- 19200 = 19200 bps

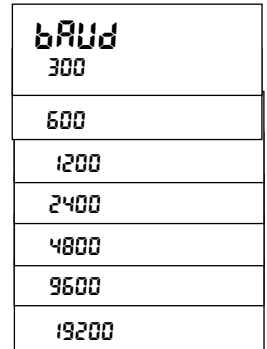
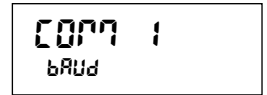

3.10.3 Parity

Set the data bits and parity.

- 7 EVEN = 7 data bits, even parity
- 7 ODD = 7 data bits, odd parity
- 7 NONE = 7 data bits, no parity
- 8 NONE** = 8 data bits, no parity

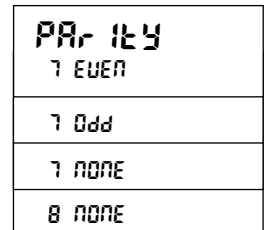
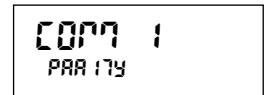

3.10.4 Stop Bit

Set the number of stop bits.

- 1 = 1 stop bit
- 2 = 2 stop bits

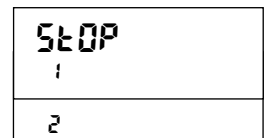
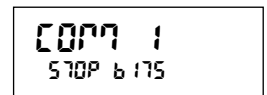

3.10.5 Handshake

Set the flow control method.

- NONE = no handshaking
- XON-XOFF = XON/XOFF handshaking
- HARDWARE = hardware handshaking (COM1 menu only)

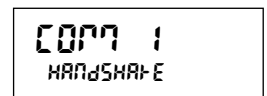

3.10.6 Address

Set the communication address (COM2 menu only).

- OFF = no address
- 01 to 99 = address 01 to 99

NOTE: The Address menu item is only displayed in the COM2 menu if the optional RS485/RS422 PC Board is installed.

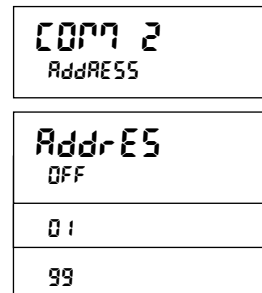

3.10.7 Alternate Command Sub-menu

Enter this sub-menu to set a different command character for the P (Print), T (Tare) or Z (Zero) commands.

NOTE: The selected character can only be used for one command.

Alternate Print Command

Set the alternate command character for Print.

Settings of A to Z are available. The default setting is **P**.

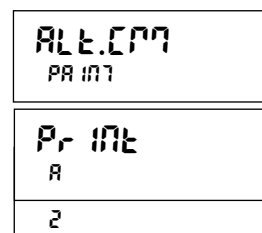

Alternate Tare Command

Set the alternate command character for Tare.

Settings of A to Z are available. The default setting is **T**.

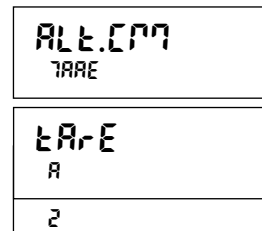

Alternate Zero Command

Set the alternate command character for Zero.

Settings of A to Z are available. The default setting is **Z**.

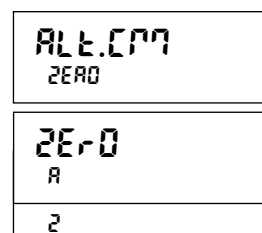

3.10.8 End COM1, End COM2

Advance to the next menu or return to the top of the current menu.

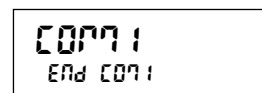

3.11 I-O Menu

Enter this menu to set the optional input and output device parameters.

3.11.1 Reset

Reset the I-O menu to the factory defaults.

- NO = not reset
- YES = reset

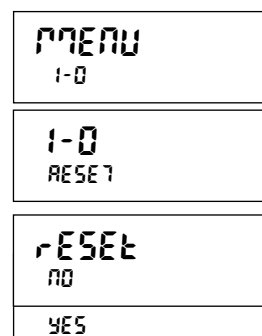

3.11.2 External Input

Set the function to be controlled by an optional external input device, such as a footswitch.

- OFF** = disabled
- TARE** = equivalent to pressing the **TARE** button.
- ZERO** = equivalent to pressing the **ZERO** button.
- PRINT** = equivalent to pressing the **PRINT** button.
- FUNCTION** = equivalent to pressing the **FUNCTION** button.
- S-S** = when the optional relay pc board is installed, the first external input changes the state of the relay; the second external input returns the relay to the original state (START-STOP).
- T-S-S** = when the optional relay pc board is installed, the first external input changes the state of the relay; the second external input returns the relay to the original state (TARE-START-STOP).

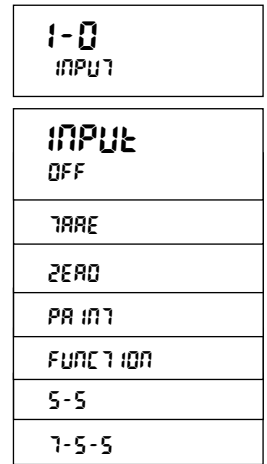

3.11.3 Input Beep

Set the beeper response to an external input.

- OFF** = the beeper does not sound.
- ON** = the beeper sounds.



3.11.4 Relay Output Sub-menu

Set the relay output parameters.

NOTE: The Relay Output sub-menu and associated menu items are not displayed unless the optional Relay PC Board is installed.

Type

Set the initial state of the relay.

- OPEN** = the relay output is normally open.
- CLOSED** = the relay output is normally closed.

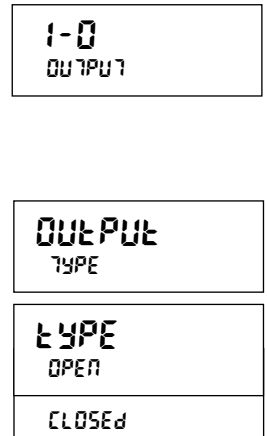

CAUTION: The normally closed relay condition is only active while the indicator is powered on. When powered off or when power is removed, the relay condition returns to a normally open condition. Restoring power to the indicator will restore the closed condition of the relays.

Output Sequence

Set how the relay outputs react as the weight reading changes from under to accept, accept to over.

- NORMAL** = the previously enabled relay will be disabled as the next relay is enabled.
- HOLD** = the previously enabled relay will hold the same state as the next relay is enabled.

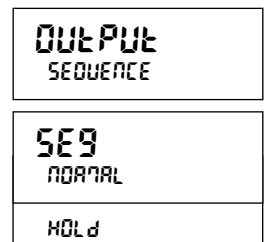

Contact

Set the timing of the relay contacts.

- SIMULTANEOUS** = the relays open or close at the same time.
- B-B-M = the relay opens before the next relay closes (break-before-make).
- M-B-B = the relay closes before the next relay opens (make-before-break).

NOTE: Break-before-make has a 100 ms delay. Make-before-break has a 100 ms over-lap.

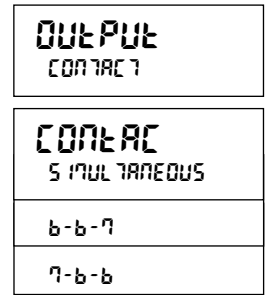

Stable

Set the stability condition for the relay to change state.

- OFF** = relay changes are immediate.
- ON** = relay changes are delayed until the reading becomes stable.

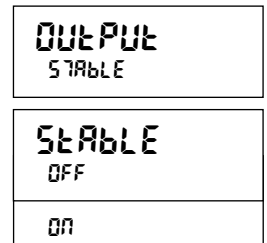

3.11.5 End I-O

Advance to the next menu or return to the top of the current menu.

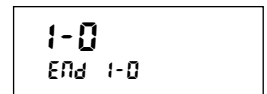

3.12 Menu Lock Menu

Use this menu to prevent unauthorized changes to menu settings. When the security switch is set to ON, the locked menus can be viewed but not changed.

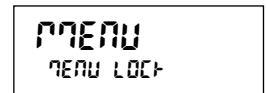

3.12.1 Reset

Reset the Menu Lock menu to the factory defaults. Factory default settings are shown in bold.

- NO** = not reset
- YES** = reset

NOTE: Settings for Legal for Trade controlled menu items are not reset.

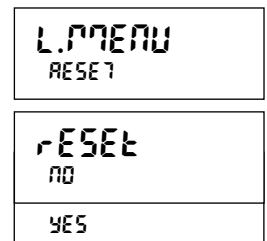

3.12.2 Lock Calibration

Set the status.

- OFF** = the Calibration menu is not locked.
- ON** = the Calibration menu is locked.

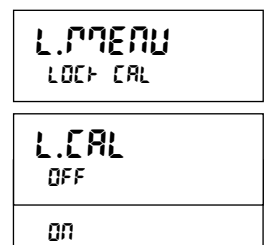

3.12.3 Lock Setup

Set the status.

- OFF** = the Setup menu is not locked.
- ON** = the Setup menu is locked.

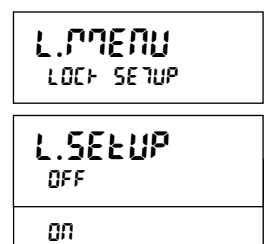

3.12.4 Lock Readout

Set the status.

- OFF** = the Readout menu is not locked.
ON = the Readout menu is locked.

L.MENU LOCK READOUT

L.READ OFF
ON

3.12.5 Lock Mode

Set the status.

- OFF** = the Mode menu is not locked.
ON = the Mode menu is locked.

L.MENU LOCK MODE

L.MODE OFF
ON

3.12.6 Lock Unit

Set the status.

- OFF** = the Unit menu is not locked.
ON = the Unit menu is locked.

L.MENU LOCK UNIT

L.UNIT OFF
ON

3.12.7 Lock Print1

Set the status.

- OFF** = the Print1 menu is not locked.
ON = the Print1 menu is locked.

L.MENU LOCK PRINT1

L.PRt1 OFF
ON

3.12.8 Lock Print2

Set the status.

- OFF** = the Print2 menu is not locked.
ON = the Print2 menu is locked.

L.MENU LOCK PRINT2

L.PRt2 OFF
ON

3.12.9 Lock COM1

Set the status.

- OFF** = the COM1 menu is not locked.
ON = the COM1 menu is locked.

L.MENU LOCK COM1

L.COM1 OFF
ON

3.12.10 Lock COM2

Set the status.

- OFF** = the COM2 menu is not locked.
ON = the COM2 menu is locked.

L.MENU LOCK COM2

L.COM2 OFF
ON

3.12.11 Lock GMP

Set the status.

- OFF** = the GMP menu is not locked.
ON = the GMP menu is locked.

```
L.MENU
LOC+ GMP
```

```
L.GMP
OFF
ON
```

3.12.12 Lock I-O

Set the status.

- OFF** = the I-O menu is not locked.
ON = the I-O menu is locked.

```
L.MENU
LOC+ I-O
```

```
L.I-O
OFF
ON
```

3.12.13 End Menu Lock

Advance to the next menu or return to the top of the current menu.

```
L.MENU
END MENULOC+
```

3.13 Key Lock Menu

Use this menu to prevent unauthorized access to button functions.

When the security switch is set to ON, the locked buttons are disabled.

```
MENU
KEY LOC+
```

3.13.1 Reset

Reset the Key Lock menu to the factory defaults. Factory default settings are shown in bold.

- NO** = not reset
YES = reset

```
L.KEY
RESET
```

```
RESET
NO
YES
```

3.13.2 Lock All Buttons

Set the status.

- OFF** = all buttons are not locked.
ON = all buttons are locked.

```
L.KEY
LOC+ ALL
```

```
L.ALL
OFF
ON
```

3.13.3 Lock Off Button

Set the status.

- OFF** = the **Off** button is not locked.
ON = the **Off** button is locked.

```
L.KEY
LOC+ OFF
```

```
L.OFF
OFF
ON
```

3.13.4 Lock Zero Button

Set the status.

- OFF** = the **Zero** button is not locked.
ON = the **Zero** button is locked.

```
L.KEY
LOC+ ZERO
```

```
L.ZERO
OFF
ON
```

3.13.5 Lock Print Button

Set the status.

- OFF** = the **PRINT** button is not locked.
ON = the **PRINT** button is locked.

L.FEY LOCK PRINT

L.PRINT OFF
ON

3.13.6 Lock Unit Button

Set the status.

- OFF** = the **Unit** button is not locked.
ON = the **Unit** button is locked.

L.FEY LOCK UNIT

L.UNIT OFF
ON

3.13.7 Lock Function Button

Set the status.

- OFF** = the **FUNCTION** button is not locked.
ON = the **FUNCTION** button is locked.

L.FEY LOCK FUNC

L.FUNC OFF
ON

3.13.8 Lock Mode Button

Set the status.

- OFF** = the **Mode** button is not locked.
ON = the **Mode** button is locked.

L.FEY LOCK MODE

L.MODE OFF
ON

3.13.9 Lock Tare Button

Set the status.

- OFF** = the **TARE** button is not locked.
ON = the **TARE** button is locked.

L.FEY LOCK TARE

L.TARE OFF
ON

3.13.10 Lock Menu Button

Set the status.

- OFF** = the **Menu** button is not locked.
ON = the **Menu** button is locked.

L.FEY LOCK MENU

L.MENU OFF
ON

3.13.11 Lock Library Button

Set the status.

- OFF** = the **LIBRARY** button is not locked.
ON = the **LIBRARY** button is locked.

L.LIB
LOCK LIBRARY

L.LIB
OFF
ON

3.13.12 Lock Info Button

Set the status.

- OFF** = the **Edit** button is not locked.
ON = the **Edit** button is locked.

L.INFO
LOCK INFO

L.INFO
OFF
ON

3.13.13 End Lock

Advance to the next menu or return to the top of the current menu.

L.INFO
END KEY LOCK

3.14 End Menu

Advance to the Calibration Menu or exit the menu and return to the current application mode.

PMENU
END

3.15 Securing the Menu and Key Lock menu settings

A slide switch located on the Main PC Board inside the housing is used to secure the Menu Lock and Key Lock menu settings. When the switch is set to the ON position, the Menu Lock and Key Lock menu settings may be viewed but not changed.

Open the housing as explained in Section 2.3.1. Set the position of the switch to ON as shown in Section 1.2, Figure 1-3, Item 11.

When the switch is in the ON position, the start up display includes the LOCK ON message.

OHAUS
LOCK ON

Note: This switch is also used in conjunction with the Legal for Trade menu item.

When the Legal for Trade menu is set to ON, the switch must be set to the ON position to prevent calibration and changes to metrologically significant settings. Refer to Section 6 for more information.

4. OPERATION

4.1 Turning Indicator On/Off

To turn the indicator on, press **ON/ZERO Off**. The indicator performs a display test followed by a series of informational displays, and then enters the last active mode.

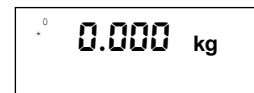

To turn the indicator off, press and hold **ON/ZERO Off** until -OFF- appears.

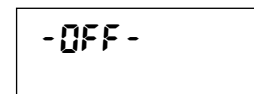

If powered by AC mains, the indicator enters standby and displays the clock.

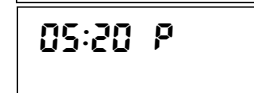

If powered by batteries, the indicator turns off completely.



4.2 Zero Operation

Press **ON/ZERO Off** to zero the display.

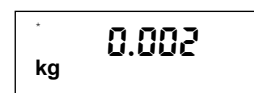

NOTE: The display must be stable and within the Zero Range.



4.3 Manual Tare

Place the container on the scale and press **TARE**.

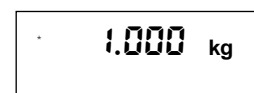

NOTE: The display must be stable.

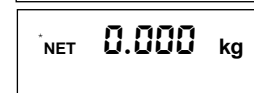

To clear the tare, remove all weight from the scale and press **TARE**.

4.4 Preset Tare

Enter the preset tare value using the numeric keypad, then press **TARE**. The display will show the PT symbol and the tare value as a negative number.

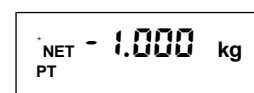

To clear the preset tare, remove all weight from the scale and press **TARE**.

NOTE: The preset tare value may also be entered or cleared using the xT command. (See Section 5.1.)

4.5 Auto Tare

When Auto Tare is set ON in the Setup menu, the initial item placed on the scale is automatically tared.

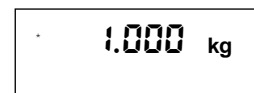

The tare value is automatically cleared when the weight on the scale is fully removed.

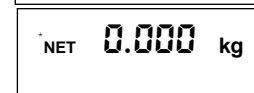

4.6 Changing Units of Measure

Press and hold **Units** until the desired unit of measure is displayed, then release the button.

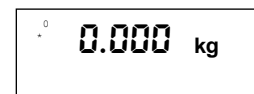

NOTE: Only units of measure enabled in the Unit menu will be displayed. (See Section 3.7.)



4.7 Printing Data

Press the **PRINT** button to send data to a printer or computer.

NOTE: To ensure that the desired data is output correctly, first set the printing parameters (Section 3.9) and the Communication parameters (Section 3.10).

NOTE: Data may also be printed using the P command. (See Section 5.1.)

4.8 Dual Scale Operation

If a second scale base is attached to the indicator, press and hold the **1s2** button to alternate the display between the readings for scale 1 and scale 2. The scale symbol on the display identifies which scale is active. **1s** indicates that scale 1 is active. **s2** indicates that scale 2 is active.

NOTE: DUAL SCALE must be set to ON in the SETUP menu and the second scale must be set up and calibrated.



4.9 Application Modes

Press and hold **Mode** until the desired application mode is displayed, then release the button.

NOTE: Only modes enabled in the Mode menu will be displayed. (See Section 3.6.)

4.9.1 Weighing

Use this mode to weigh items in the desired unit of measure.

Place the item to be weighed on the scale and read the value on the display.

NOTES: Press **FUNCTION** to display the weight briefly in 10x expanded resolution if Accumulate is set to OFF in the Setup menu.

Press **FUNCTION** to add the displayed count to the accumulation data if Accumulate is set to MANUAL in the Setup menu.

If Accumulate is set to AUTO in the Setup menu, the displayed weight is automatically added to the accumulation data when the reading becomes stable.

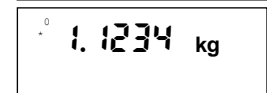
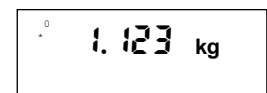
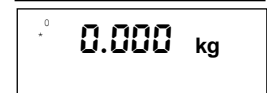

4.9.2 Parts Counting

Use this mode to count parts of uniform weight. The indicator supports positive counting and negative counting. Positive counting refers to counting parts as they are added to the empty scale. Negative counting refers to counting parts that have already been added to the scale.

NOTES: If Accumulate is set to OFF in the Setup menu, the second line displays the weight in current unit by default. Pressing FUNC can switch the second line display between weight and APW.

If Accumulate is set to MANUAL in the Setup menu, press **FUNCTION** to add the displayed count to the accumulation data.

If Accumulate is set to AUTO in the Setup menu, the displayed count is automatically added to the accumulation data when the reading becomes stable.



Defining the Average Piece Weight for Positive Counting

To define the average piece weight (APW), place a specified quantity on the scale.

When the **Mode** button is released, CLEAR APW? appears.

Press **No** to use the stored APW or press **Yes** to establish a new APW.

When establishing a new APW, the display alternates between PLACE 10 OR and ENTER APW.

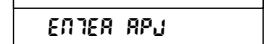
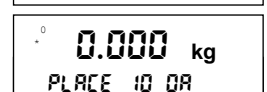

NOTE: To change the specified number of pieces, press **No** repeatedly. The display will step through the alternative sample sizes: PLACE 5, PLACE 10, PLACE 20, PLACE 50 and PLACE 100.

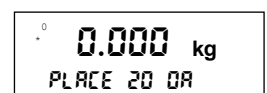

To define the APW using parts, place the specified quantity of parts on the scale and press the **FUNCTION** button.

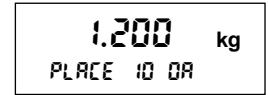

To define the APW using a numeric value, enter the value using the keypad, then press the **FUNCTION** button.

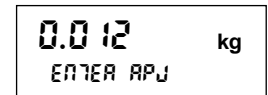

Positive Counting

After defining the APW, place the items to be counted on the scale and read the value on the display. The number of pieces appears on the top line and the actual weight appears on the bottom line.

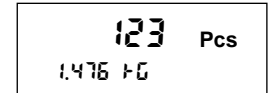

Defining the Average Piece Weight for Negative Counting

Define average piece weight (APW) by removing a specified quantity from a full container on the scale.

When **Mode** is released, CLEAR APW? is displayed.

Press **No** to use the stored APW or press the **Yes** button to define a new APW.



When establishing a new APW, the display alternates between PLACE 10 OR and ENTER APW.

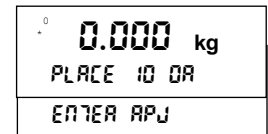

To enable negative counting, press and hold the +/- button until the display shows PLACE TOTAL.

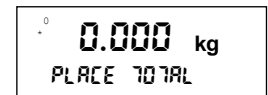

To establish the APW, place the entire quantity of parts on the scale and press **FUNCTION**.

Then remove the specified quantity of parts from the scale and press **FUNCTION**.

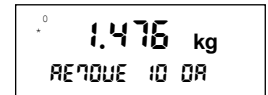

NOTE: To change the specified number of pieces, press **No** repeatedly. The display will step through the alternative sample sizes: PLACE 5, PLACE 10, PLACE 20, PLACE 50 and PLACE 100.

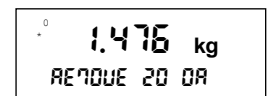

NOTE: At this stage, it is still possible to define the APW by entering the value using the keypad and pressing the **FUNCTION** button.

NOTE: The Total PCS will be cleared when the APW is re-established.

Negative Counting

After defining the APW, read the value on the display. The number of pieces appears on the top line and the actual weight appears on the bottom line.

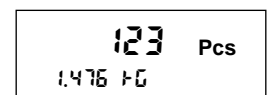

4.9.3 Percent Weighing

Use this mode to compare the weight of items as a percentage of a Reference Weight.

Defining the Reference Weight

When the **Mode** button is released, CLEAR REF? is displayed. Press **No** to use the stored Reference Weight or press **Yes** to establish a new Reference Weight.

When establishing a new Reference Weight., the display alternates between PLACE REF OR and ENTER REF.

To establish the Reference Weight using an item, place the item on the scale and press **FUNCTION**.

To establish the Reference Weight using a numeric value, enter the value using the keypad, then press **FUNCTION**.

Percent Weighing

After defining the reference weight, place an item on the scale and read the value on the display. The percent value is displayed on the top line and the actual weight is displayed on the bottom line.

NOTE: Press **FUNCTION** to briefly display the Reference Weight.

4.9.4 Dynamic Weighing

Use this mode to weigh moving items or large items that block the display.

NOTE: If Accumulate is set to AUTO in the Setup menu, the held weight is automatically added to the accumulation data.

Manual operation (DYNAMIC is set to MANUAL in the MODE menu)

When the display shows READY, place the item on the scale.

Press **FUNCTION** to average the readings for the time period defined in the LEVEL setting (Section 3.6.6).

When averaging is completed, the dynamic icon flashes. The averaged weight and HOLD are displayed until **FUNCTION** is pressed again.

Semi-automatic operation (DYNAMIC is set to SEMI in the MODE menu)

When the display shows READY, place the item on the scale. The readings are automatically averaged for the time period defined in the LEVEL setting. The averaged weight and HOLD are displayed until the item is removed and **FUNCTION** is pressed.

Automatic operation (DYNAMIC is set to AUTOMATIC in the MODE menu)

When the display shows READY, place the item on the scale. The readings are automatically averaged for the time period defined in the LEVEL setting. The averaged weight and HOLD are displayed until the item has been removed from the scale for 10 seconds.

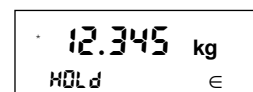
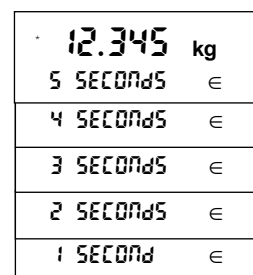
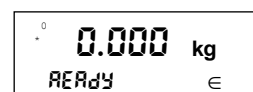
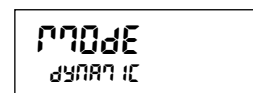
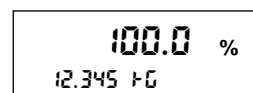
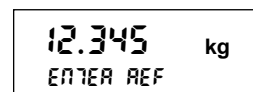
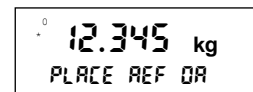

4.9.5 Check Weighing

Use this mode to compare the weight or quantity of items to a target weight range. The indicator supports positive, negative and zero check weighing.



- NOTES:** If Accumulate is set to OFF in the Setup menu, press **FUNCTION** to display the limits.
 If Accumulate is set to MANUAL in the Setup menu, press **FUNCTION** to add the displayed weight to the accumulation data.
 If Accumulate is set to AUTO, the stable weight is automatically added to the accumulation data.

Defining the Under and Over Limits

When the **Mode** button is released, EDIT LIMITS? appears. Press **No** to use the stored UNDER and OVER limits or press **Yes** to define new limits.

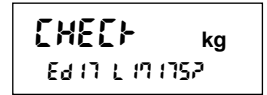

When defining the limits, the display shows UNDER and the current setting. To keep the current under limit, press **Yes**.



To change the UNDER limit, enter the new limit using the keypad. To change the sign of the limit, press and hold **+/- (CLR/+/-)**. Then press **FUNCTION**.

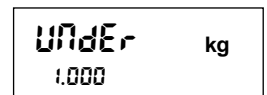

The display shows OVER and the current setting. To keep the current over limit, press **Yes**.



To change the over limit, enter the new limit using the keypad. To change the sign of the limit, press and hold **+/-**. Then press **FUNCTION**.



Positive Check Weighing

Positive check weighing is used to determine when the material added to the scale is within the target range. In this case, the under and over limits must be positive values. (The OVER limit must be greater than the UNDER limit.)

Add material to the scale until it is within the ACCEPT range.

- If the item is lighter than the UNDER limit, the yellow UNDER LED will light.
- If the item is within the target weight range, the green ACCEPT LED will light.
- If the item is heavier than the OVER limit, the red OVER LED will light.



Negative Check Weighing

Negative check weighing is used to determine when the material removed from the scale is within the target range. In this case, the UNDER and OVER limits are both negative values. (The UNDER limit must be greater than the OVER limit.)

Place the item to be weighed on the scale and press **TARE**.
 Remove a portion of the item until it is within the ACCEPT range.

- If the item is heavier than the UNDER limit, the yellow UNDER LED will light.
- If the item is within the target weight range, the green ACCEPT LED will light.
- If the item is lighter than the OVER limit, the red OVER LED will light.

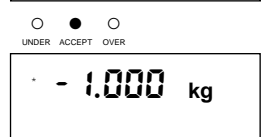

Zero Check Weighing

Zero check weighing is used when comparing subsequent samples to an initial reference sample. In this case, the UNDER limit must be a negative value and the OVER limit must be a positive value.

Place the reference item on the scale and press **TARE**. Remove the reference sample and place the item to be compared on the scale to determine if it is within the ACCEPT range.

If the item is lighter than the UNDER limit, the yellow UNDER LED will light. If the item is within the target weight range, the green ACCEPT LED will light. If the item is heavier than the OVER limit, the red OVER LED will light.

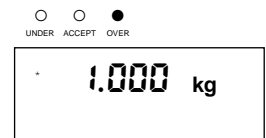
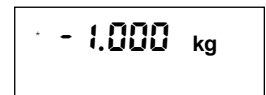

4.9.6 PCS (Pieces Counting) Check Weighing

Set Checkweigh to PCS in the Mode Menu. Use this mode to compare the quantity of items to a target quantity range. The indicator supports positive, negative and zero check counting.

- NOTES:** If Accumulate is set to OFF in the Setup menu, press the **FUNCTION** button to briefly display the UNDER and OVER limits and the APW value.
 If Accumulate is set to MANUAL in the Setup menu, press the **FUNCTION** button to add the displayed quantity to the accumulation data.
 If Accumulate is set to AUTO, the stable quantity is automatically added to the accumulation data.

Defining the Average Piece Weight (APW) and the Under and Over Limits

If CHECK was set to PCS in the MODE menu:

When the Mode key is released, the display shows: CHECK on the first line, CLEAR APW? on the second line, and the **Pcs** icon appears on the right.

Press **No** to use the previously defined APW and go to the step for setting UNDER and OVER Limits.
 Press **Yes** to define a new APW.

NOTE: Check Counting mode shares the same APW with Counting mode.

When establishing a new APW, the display alternates between PLACE 10 OR and ENTER APW.

NOTE: To change the specified number of pieces, press **No** repeatedly. The display will step through the alternative sample sizes: PLACE 5, PLACE 10, PLACE 20, PLACE 50 and PLACE 100.

To define the APW using samples, place the samples on the scale, then press **FUNCTION**.
 To define the APW using a numeric value, enter the value using the keypad, then press **FUNCTION**.

NOTE: The APW is taken in the current weighing unit.

NOTE: The Total PCS will be cleared when the APW is re-established.

After the APW is defined, a screen prompt asks: EDIT LIMITS?
 (If **Kg** appears to the right of CHECK instead of **Pcs**, change the Checkweigh setting in the MODE menu.)
 Press **No** to use the previously defined UNDER and OVER Limits.
 Press **Yes** to set new limits.

When defining the limits, the display shows UNDER and the current setting.
 To keep the current UNDER limit, press **Yes**, or
 To change the UNDER limit, use the keypad to enter the desired number and press **Yes**.
 (To change the sign of the limit, press and hold **+/-** before pressing **Yes**.)

The display next shows OVER and the current setting.
 To keep the current OVER limit, press **Yes**, or
 To change the OVER limit, use the keypad to enter the new limit, and press **Yes**.
 (To change the sign of the limit, press and hold **+/-** before pressing **Yes**.)

The indicator is now ready for Check Counting. It will show:
 – ACCEPT if the defined number of pieces are placed on the scale, or
 – OVER if the number of pieces exceeds the limit, or
 – UNDER when the number of pieces is less than the limit.

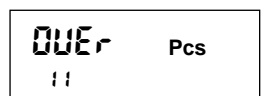
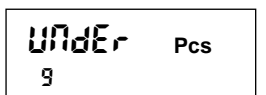
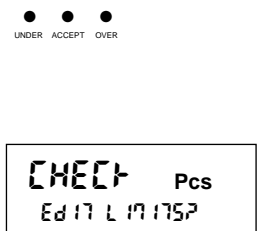
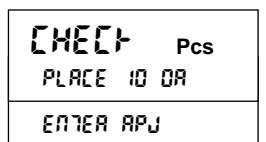
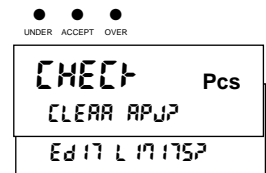

Positive Check Counting

Use Positive Check Counting to determine when the quantity added to the scale is within the target range. In this case, the UNDER and OVER limits must be positive values. The OVER limit must be greater than the UNDER limit.

Add items to the scale until the quantity is within the accept range.

If the quantity is lower than the UNDER limit, the yellow UNDER LED will light. If the quantity is within the target quantity range, the green ACCEPT LED will light. If the quantity is higher than the OVER limit, the red OVER LED will light.

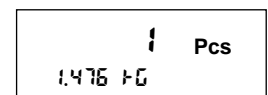
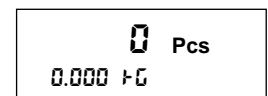
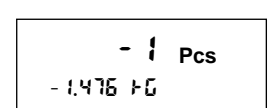
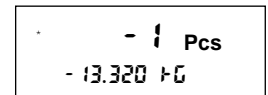
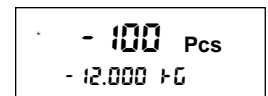
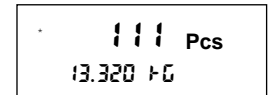
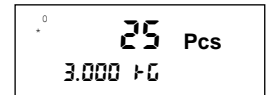

Negative Check Counting

Negative Check Counting is used to determine when the quantity removed from the scale is within the target range. In this case, the under and over limits are both negative values. The under limit must be greater than the over limit.

Place the items to be counted on the scale and press **TARE**. Remove items until the quantity is within the ACCEPT range.

If the quantity is higher (less negative) than the UNDER limit, the yellow UNDER LED will light. If the quantity is within the target quantity range, the green ACCEPT LED will light. If the quantity is lower (more negative) than the OVER limit, the red OVER LED will light.

Zero Check Counting

Zero check counting is used when comparing subsequent samples to an initial reference sample. In this case, the UNDER limit must be a negative value and the OVER limit must be a positive value.

Place the reference quantity on the scale and press **TARE**. Remove the reference quantity and place the quantity to be compared on the scale to determine if it is within the ACCEPT range.

If the quantity is lower than the UNDER limit, the yellow UNDER LED will light. If the quantity is within the target quantity range, the green ACCEPT LED will light. If the quantity is higher than the OVER limit, the red OVER LED will light.

4.10 Library

When an item is processed on a regular basis, the item's data may be stored in memory for future use.

The following data is stored for each mode.

Mode	Record ID	Name	Preset Tare	APW	Reference Wt.	Under Limit	Over Limit	Level
Weighing	✓	✓	✓					
Counting	✓	✓	✓	✓				
Percent Weighing	✓	✓	✓		✓			
Check Weighing	✓	✓	✓			✓	✓	
Check Counting	✓	✓	✓	✓		✓	✓	
Dynamic Weighing	✓	✓	✓					✓

NOTES: LIBRARY must be set to ON in the SETUP menu (Section 3.4.18).
Up to 256 library records may be stored.

4.10.1 Storing Library Data

Select the desired Mode using the **Mode** button. Press **LIBRARY** to view the next available memory location for the active mode.

The display shows the Record ID with a mode prefix and a unique identification number.

- Wxxx = Weighing records
- PCxxx = Parts Counting records
- Pxxx = Percent Weighing records
- Cxxx = Check Weighing records
- CCxxx = Check Counting records
- Dxxx = Dynamic Weighing records

Press **No** to advance to the next Record ID or press **Yes** to begin entering the library data for the displayed Record ID.

The data type appears on the first line. The data value appears on the second line. Use the keypad to change the data value. Press **Yes** to accept the data value and move to the next data type.

Weighing Mode Library Records

The Name of the item is displayed. By default, the Name is the same as the Record ID. Use the keypad to change the value. Press **Yes** to accept the value.

NOTE: The Name length can be a maximum of 7 characters.

The Preset Tare of the item is displayed. By default, the current Tare is used as the Preset Tare value. Use the keypad to change the value. Press **Yes** to accept the value.

To save the record, press **Yes**.

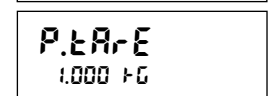
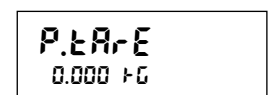
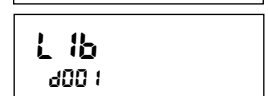
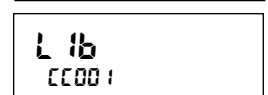
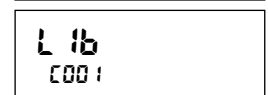
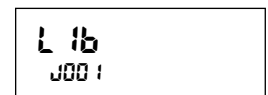

Counting Mode Library Records

The Name of the item is displayed. By default, the Name is the same as the Record ID. Use the keypad to change the value. Press **Yes** to accept the value.

NOTE: The Name length can be a maximum of 7 characters.

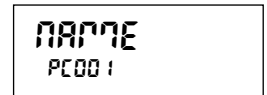

The Preset Tare of the item is displayed. By default, the current Tare is used as the Preset Tare value. Use the keypad to change the value. Press **Yes** to accept the value.



The APW of the item is displayed. By default, the current APW is used as the APW value. Use the keypad to change the value. Press **Yes** to accept the value.

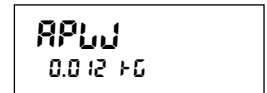
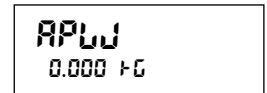

To save the record, press **Yes**.



Percent Weighing Mode Library Records

The Name of the item is displayed. By default, the Name is the same as the Record ID. Use the keypad to change the value. Press **Yes** to accept the value.

NOTE: The Name length can be a maximum of 7 characters.

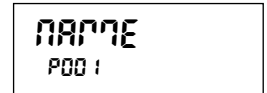

The Preset Tare of the item is displayed. By default, the current Tare is used as the Preset Tare value. Use the keypad to change the value. Press **Yes** to accept the value.

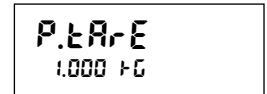
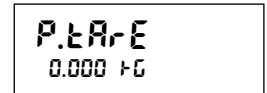

The Reference Weight of the item is displayed. By default, the current Reference Weight is used as the Reference Weight value. Use the keypad to change the value. Press **Yes** to accept the value.

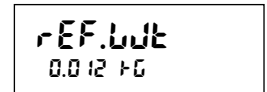
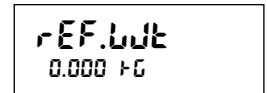

To save the record, press **Yes**.



Check Weighing Mode Library Records

The Name of the item is displayed. By default, the Name is the same as the Record ID. Use the keypad to change the value. Press **Yes** to accept the value.

NOTE: The Name length can be a maximum of 7 characters.

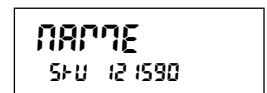
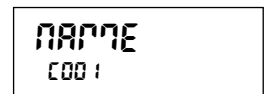

The Preset Tare of the item is displayed. By default, the current Tare is used as the Preset Tare value. Use the keypad to change the value. Press **Yes** to accept the value.

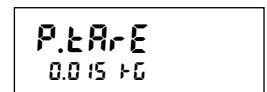
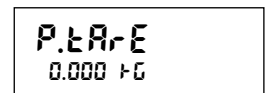

The Under Limit of the item is displayed. By default, the current UNDER Limit is used as the UNDER Limit value. Use the keypad to change the value. Press **Yes** to accept the value.

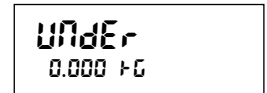

The OVER Limit of the item is displayed. By default, the current OVER Limit is used as the OVER Limit value. Use the keypad to change the value. Press **Yes** to accept the value.

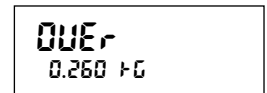
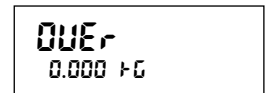

To save the record, press **Yes**.



Check Counting Mode Library Records

The Name of the item is displayed. By default, the Name is the same as the Record ID. Use the keypad to change the value. Press **Yes** to accept the value.

NOTE: The Name length can be a maximum of 7 characters.

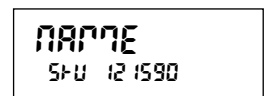
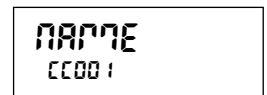

The Preset Tare of the item is displayed. By default, the current Tare is used as the Preset Tare value. Use the keypad to change the value. Press **Yes** to accept the value.

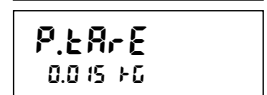
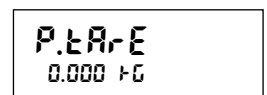

The APW of the item is displayed. By default, the current APW is used as the APW value. Use the keypad to change the value. Press **Yes** to accept the value.

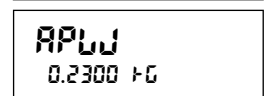
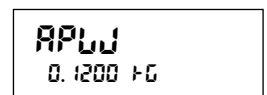

The UNDER Limit of the item is displayed. By default, the current UNDER Limit is used as the UNDER Limit value. Use the keypad to change the value. Press **Yes** to accept the value.

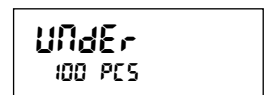

The OVER Limit of the item is displayed. By default, the current Over Limit is used as the OVER Limit value. Use the keypad to change the value. Press **Yes** to accept the value.



To save the record, press **Yes**.



Dynamic Weighing Mode Library Records

The Name of the item is displayed. By default, the Name is the same as the Record ID. Use the keypad to change the value. Press **Yes** to accept the value.

NOTE: The Name length can be a maximum of 7 characters.

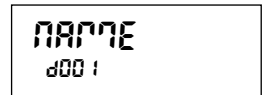

The Preset Tare of the item is displayed. By default, the current Tare is used as the Preset Tare value. Use the keypad to change the value. Press **Yes** to accept the value.

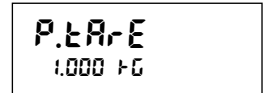
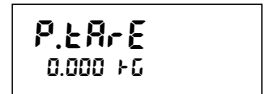

The Level (averaging time) of the item is displayed. By default, the current Level is used as the Level value. Use the keypad to change the value. Press **Yes** to accept the value.

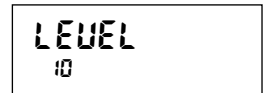
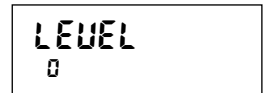

To save the record, press **Yes**.

4.10.2 Retrieving Data

Press **Mode** to select the desired Mode. Enter the Record ID number (without prefix) and press **LIBRARY** to view the desired memory location. To view a different Record ID, press **No**.

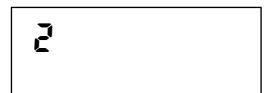

Press **Yes** to load the data for the displayed Record ID.

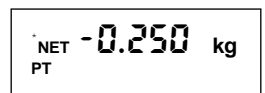

4.10.3 Editing Stored Data

Press **Mode** to select the desired Mode. Enter the Record ID number (without prefix) and press **LIBRARY** to view the desired memory location.

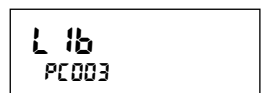

The Record ID is displayed on the first line and the Name of the item is displayed on the second line. Press and hold **Edit** to begin editing the library data.

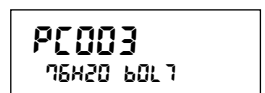

If desired, edit the displayed data value using the keypad. Then press **Yes** to view the next data type.

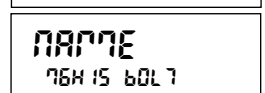

If desired, edit the displayed data value using the keypad. Then press **Yes**.

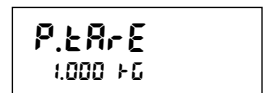
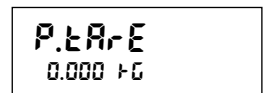

After all data types have been viewed, press **Yes** to save the changes.

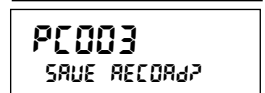

4.10.4 Deleting Stored Data

Select the desired Mode using the **Mode** button. Enter the Record ID number (without prefix) and press **LIBRARY** to view the desired memory location. To view a different Record ID, press **No**.

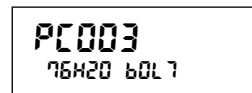
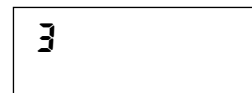

Press the **CLR** button, then **Yes** to delete the data for the current library record. The display returns to the current mode.

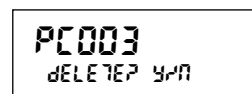

Note: If you do not want to delete the library record, press **No**. The display returns to the current library record. Press **Exit** to return to the current mode.

4.11 Accumulation and Statistics

The Accumulation feature enables manual or automatic totalizing of displayed values. Statistical data is stored in memory for review and printing.

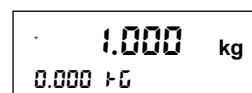

Notes: Set ACCUMULATE to MANUAL or AUTO in the SETUP menu. The Accumulation function is available in Weighing, Counting, Dynamic and Check Weighing modes. Accumulation data is stored separately for each mode. To include statistics data when printing, set INFORMATION to ON in the PRINT CONTENT menu.

4.11.1 Accumulating Displayed Values

With ACCUMULATE set to MANUAL, place the item on the scale and press **FUNCTION** to accumulate the displayed value.

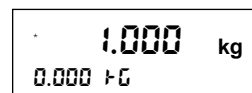

With ACCUMULATE set to AUTO, place the item on the scale. The displayed value is accumulated automatically.

The accumulated value is displayed on the second line.

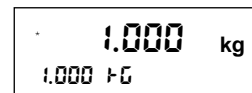

Note: The item must be removed from the scale before the next item can be accumulated.

4.11.2 Viewing Statistics Data

To view the statistics data, press **INFO (0)** on the keypad). The following statistics data will be displayed momentarily: number of weighings, total, average, standard deviation, minimum, maximum, and difference.

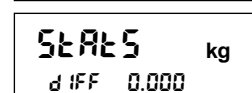
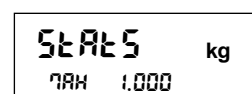
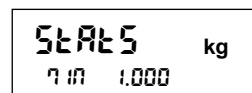
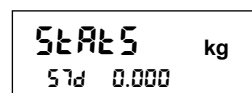
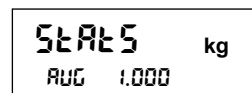
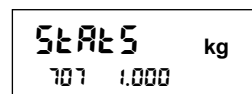
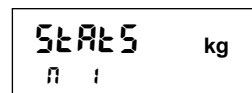

4.11.3 Clearing Statistics Data

To clear the accumulation value and statistics data, press the **CLR** button while the statistics information is being displayed. When the display shows CLEAR STATS?, press the **Yes** button to clear the statistics data or press the **No** button to keep the statistics data.

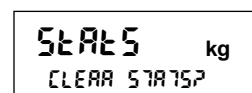

4.12 Alibi Memory

When the optional Alibi Memory pc board is installed, weighing results may be stored in memory for future reference by pressing **PRINT** or sending the "P" command. Up to 262,112 alibi records may be stored.

The following data is stored for each mode.

Record ID
Weight value
Tare value
Date
Time
Scale number

NOTES: ALIBI must be set to ON in the SETUP menu.

When the Alibi Memory is full, the Record ID counter begins over at 000001.

The new data overwrites the previously stored data for that record.

4.12.1 Viewing Alibi Data

To view alibi records, press and hold the **Info** button until ALIBI is displayed. When the button is released, the display shows the first alibi Record ID. Press **Yes** to view that record, or press **No** or **Back** to move to the desired Record ID.

Alternatively, enter the Record ID number using the keypad and press **Function**.

Press **Yes** to view the record.

The stored data is displayed with the value on the first line and the Record ID and data type on the second line. To view the remaining data types, repeatedly press **No**.

To return to the active mode, press **Exit**.

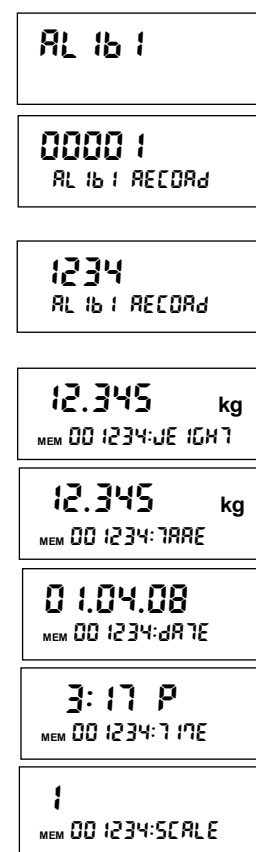

4.12.2 Printing Alibi Data

To print alibi records, enter the menu and navigate to the Print>List>Alibi menu (see Section 3.9.6), then press **Yes**.

```
Print 1
L 157
```

```
List
AL 16 1
```

The display shows the first stored record number. Press **Yes** to accept the displayed value as the starting record number in the range to be printed.

```
Start
00000 1
```

If a different starting record number is desired:

- Press **No** to increase the Alibi record number.
- Or press **Back** to jump to the last Alibi record number stored, then decrease the Alibi record number,
- Or enter the Alibi record number using the keypad.
- Then press **Yes** to accept the displayed value as the starting record number in the range to be printed.

```
Start
000002
```

```
Start
00 1234
```

The display shows the last stored record number. Press **Yes** to accept the displayed value as the ending record number in the range to be printed.

```
End
002345
```

If a different ending record number is desired:

- Press **No** to jump to the starting Alibi record number that was just defined.
- Or press **Back** to decrease the Alibi record number.
- Or enter the Alibi record number using the keypad.
- Then press **Yes** to accept the displayed value as the ending record number in the range to be printed.

```
End
00 1234
```

```
End
002344
```

Alibi records are printed in the format shown in Section 5.3.

NOTE: To print all Alibi records, do not change the Start and End values.

To print a single record, enter the same record number for the Start and End values.

5. SERIAL COMMUNICATION

5.1 Interface Commands

The indicator can be controlled using the commands listed below.

Command Characters ¹⁾	Function
ON	Turns the indicator on.
OFF	Turns the indicator off.
IP	Immediate print of displayed weight (stable or unstable).
P ²⁾	Print displayed weight (stable or unstable).
SP	Print on stability.
CP	Continuous print.
xP	Print on interval, where x = 1 to 3600 (seconds).
Z ²⁾	Equivalent to pressing the ZERO button.
T ²⁾	Equivalent to pressing the TARE button.
xT	Establish a preset tare, where x = the tare value in the current weighing unit.
PU	Print the current weighing unit.
xU	Change the weighing unit, where x = 1 (g), 2 (kg), 3 (lb), 4 (oz), 5 (lb:oz), 6 (t), 7 (t).
PV	Print the name, software version and LFT ON (if LFT is set to ON).
H x "text"	Enter the header line, where x = 1 to 5 (line number) and "text" = header text up to 24 characters.
Escape key and R	Global reset (all menu settings are reset to their factory default settings).

NOTES:

- 1) Commands sent to the indicator must be terminated by a carriage return (CR) or a carriage return-line feed (CRLF).
- 2) Alternate command characters may be defined by the user. Refer to Section 3.10.7.
- 3) Data output by the indicator is always terminated with a carriage return-line feed (CRLF).

5.2 Output Format

The Result Data is output in the following format.

Field:	Label ¹⁾	Space ²⁾	Weight ³⁾	Space ²⁾	Unit ⁴⁾	Space	Stability ⁵⁾	Space	G/N ⁶⁾	Space	Term. Characters ⁷⁾
Length:	≤11	≤1	9	≤1	≤5	1	≤1	≤1	≤3	≤1	≤4

- 1) In certain cases, a Label field of up to 11 characters is included. Refer to Section 5.3.
- 2) Each field is followed by a single delimiting space (ASCII 32).
- 3) The Weight field is 9 right justified characters. If the value is negative, the "-" character is located at the immediate left of the most significant digit.
- 4) The Unit field contains the unit of measure abbreviation up to 5 characters.
- 5) The Stability field contains the "?" character if the weight reading is not stable. The Stability field and the following Space field are omitted if the weight reading is stable.
- 6) The G/N field contains the net or gross indication. For net weights, the field contains "NET". For gross weights, the field contains nothing, "G" or "B", depending on the GROSS INDICATOR menu setting. Refer to Section 3.5.8.
- 7) The Termination Characters field contains CRLF, Four CRLF or Form Feed (ASCII 12), depending on the LINE FEED menu setting. (See Section 3.9.5.)

5.3 Printout Examples

Examples for modes are shown with all CONTENT settings ON and values defined for the header lines.

Content	Weigh Mode	Count Mode	Percent Mode
HEADER 1	Ohaus Corporation	Ohaus Corporation	Ohaus Corporation
HEADER 2	7 Campus Drive	7 Campus Drive	7 Campus Drive
HEADER 3	Parsippany, NJ, 07054	Parsippany, NJ, 07054	Parsippany, NJ, 07054
HEADER 4	USA	USA	USA
HEADER 5	Tel: +1-973-377-9000	Tel: +1-973-377-9000	Tel: +1-973-377-9000
TIME	01/31/08 12:30 PM	01/31/08 12:30 PM	01/31/08 12:30 PM
SCALE NUMBER	Scale No: 1	Scale No: 1	Scale No: 1
ALIBI RECORD	Alibi Record: 4	Alibi Record: 4	Alibi Record: 4
SCALE ID	Scale Id: 123456	Scale Id: 123456	Scale Id: 123456
USER ID	User Id: 123456	User Id: 123456	User Id: 123456
PROJECT ID	Project Id: 123456	Project Id: 123456	Project Id: 123456
NAME	Name: _____	Name: _____	Name: _____
LIBRARY ID	Library Id: W001	Library Id: PC001	Library Id: P001
LIBRARY NAME	Library Name: CONTAINER 1	Library Name: BOLT,M4x20	Library Name: DURUM WHEAT
RESULT	11.11 kg NET	Quantity: 12 PCS NET	Percentage: 11 % NET
GROSS	12.34 kg G	12.34 kg G	12.34 kg G
NET	11.11 kg NET	11.11 kg NET	11.11 kg NET
TARE	1.22 kg T	1.22 kg T	1.22 kg T
INFORMATION	(Not printed)	APW 0.1000 kg	Ref Wt 0.012 kg
INFORMATION	(Not printed)	(Not printed)	(Not printed)
INFORMATION	(Not printed)	(Not printed)	(Not printed)
INFORMATION	(Not printed)	(Not printed)	(Not printed)
STATISTICS	N: 12	N: 12	(Not printed)
STATISTICS	Total: 11.11 kg	Total: 144 Pcs	(Not printed)
STATISTICS	Avg: 11.11 kg	Avg: 12 Pcs	(Not printed)
STATISTICS	Std: 0.010 kg	Std: 0 Pcs	(Not printed)
STATISTICS	Min: 11.09 kg	Min: 12 Pcs	(Not printed)
STATISTICS	Max: 11.13 kg	Max: 12 Pcs	(Not printed)
STATISTICS	Diff: 0.04 kg	Diff: 0 Pcs	(Not printed)
MODE	Mode: Weighing	Mode: Counting	Mode: Percent
Content	Check Weigh Mode	Check Count Mode	Dynamic Mode
HEADER 1	Ohaus Corporation	Ohaus Corporation	Ohaus Corporation
HEADER 2	7 Campus Drive	7 Campus Drive	7 Campus Drive
HEADER 3	Parsippany, NJ, 07054	Parsippany, NJ, 07054	Parsippany, NJ, 07054
HEADER 4	USA	USA	USA
HEADER 5	Tel: +1-973-377-9000	Tel: +1-973-377-9000	Tel: +1-973-377-9000
TIME	01/31/08 12:30 PM	01/31/08 12:30 PM	01/31/08 12:30 PM
SCALE NUMBER	Scale No: 1	Scale No: 1	Scale No: 1
ALIBI RECORD	Alibi Record: 4	Alibi Record: 4	Alibi Record: 4
SCALE ID	Scale Id: 123456	Scale Id: 123456	Scale Id: 123456
USER ID	User Id: 123456	User Id: 123456	User Id: 123456
PROJECT ID	Project Id: 123456	Project Id: 123456	Project Id: 123456
NAME	Name: _____	Name: _____	Name: _____
LIBRARY ID	Library Id: C001	Library Id: C001	Library Id: D001
LIBRARY NAME	Library Name: 200 G SALAD	Library Name: BOLT,M4x20	Library Name: HORSE
RESULT	Result: 11.11 kg NET OVER	Quantity: 12 PCS NET	Final Wt: 0.200 kg NET
GROSS	12.34 kg G	12.34 kg G	12.34 kg G
NET	11.11 kg NET	11.11 kg NET	11.11 kg NET
TARE	1.22 kg T	1.22 kg T	1.22 kg T
INFORMATION	Under: 1.00 kg	APW 0.1000 kg	Level: 10
INFORMATION	Over: 2.00 kg	Under: 98 Pcs	(Not printed)
INFORMATION	(Not printed)	Over: 102 Pcs	(Not printed)
INFORMATION	(Not printed)	(Not printed)	(Not printed)
STATISTICS	N: 12	N: 12	N: 12
STATISTICS	Total: 11.11 kg	Total: 144 Pcs	Total: 11.11 kg
STATISTICS	Avg: 11.11 kg	Avg: 12 Pcs	Avg: 11.11 kg
STATISTICS	Std: 0.010 kg	Std: 0 Pcs	Std: 0.010 kg
STATISTICS	Min: 11.09 kg	Min: 12 Pcs	Min: 11.09 kg
STATISTICS	Max: 11.13 kg	Max: 12 Pcs	Max: 11.13 kg
STATISTICS	Diff: 0.04 kg	Diff: 0 Pcs	Diff: 0.04 kg
MODE	Mode: Checkweigh	Mode: Check Count	Mode: Dynamic

The CAL TEST printout is automatically printed when a Calibration Test is performed.

Calibration Test	
----- Cal Test -----	
New Cal:	10.000 kg
Old Cal:	10.000 kg
Diff:	0.000 kg
Wt. ID:	-----
----- End -----	

An example of the Alibi List printout is shown below.

Alibi List	
Alibi Record: 1	
01/31/10 12:30 PM	
Weight: 10.00 kg NET	
Tare: 2.00 kg T	
Scale: 1	
Alibi Record: 2	
01/31/10 12:35 PM	
Weight: 25.00 kg NET	
Tare: 5.00 kg T	
Scale: 1	
Alibi Record: 3	
01/31/10 12:41 PM	
Weight: 1.00 kg NET	
Tare: 0.01 kg T	
Scale: 1	

An example of the Library List printout is shown below.

Library List	
Library Id: W001	
Library Name: CONTAINER 1	
Preset Tare: 1.22 kg	
Library Id: PC001	
Library Name: BOLT,M4x20	
Preset Tare: 1.22 kg	
APW: 0.1000 kg	
Library Id: P001	
Library Name: DURUM WHEAT	
Preset Tare: 1.22 kg	
Ref Wt 0.012 kg	
Library Id: C001	
Library Name: 200 G SALAD	
Preset Tare: 1.22 kg	
Under: 1.00 kg	
Over: 2.00 kg	
Library Id: D001	
Library Name: HORSE	
Preset Tare: 1.22 kg	
Level: 10	

6. LEGAL FOR TRADE

When the indicator is used in trade or a legally controlled application it must be set up, verified and sealed in accordance with local weights and measures regulations. It is the responsibility of the purchaser to ensure that all pertinent legal requirements are met.

6.1 Settings

Before verification and sealing, perform the following steps:

1. Verify that the menu settings meet the local weights and measures regulations.
2. Perform a calibration as explained in Section 3.3.
3. Set Legal for Trade to ON in the Setup menu.
4. Exit the menu.
5. Disconnect power from the indicator and open the housing as explained in Section 2.3.1.
6. Set the position of the security switch SW1 to ON as shown in Section 1.2, Figure 1-3, Item 11.
7. Close the housing.
8. Reconnect power and turn the indicator on.
9. During power up, the display will show "LFT MODE ON", confirming that the indicator is ready to be sealed.

NOTE: When Legal for Trade is set to ON and the security switch is set to ON, the following menu settings cannot be changed: Zero Calibration, Span Calibration, Linearity Calibration, GEO, Range, Capacity, Graduation, Power On Unit, Zero Range, Auto Tare, Retain Weight, Legal for Trade, Stable Range, Auto Zero Tracking, Gross Indicator, Modes, Units, Stable Only.

NOTE: For installations that employ the audit trail sealing method, steps 5 to 8 are not required. However, the security switch may be set to ON to safeguard against unintentional changes to configuration and calibration settings.

6.2 Verification

The local weights and measures official or authorized service agent must perform the verification procedure.

6.3 Sealing

6.3.1 Physical Seals

For jurisdictions that use the physical sealing method, the local weights and measures official or authorized service agent must apply a security seal to prevent tampering with the settings. Refer to the illustrations below for sealing methods.

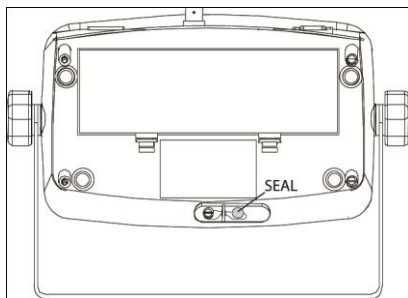

Figure 6-1. T71P Wire Seal

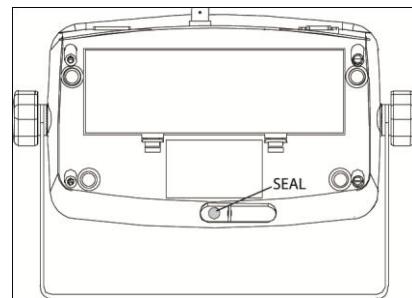

Figure 6-2. T71P Paper Seal

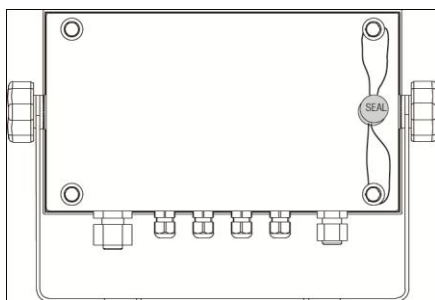

Figure 6-3. T71XW Wire Seal

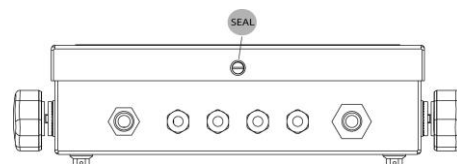

Figure 6-4. T71XW Paper Seal

When the scale base is attached to the indicator using a connector, it is necessary to seal the load cell cable to the indicator in some jurisdictions. The load cell sealing collar P/N 80500737 (Figure 6-5) is available as an accessory.

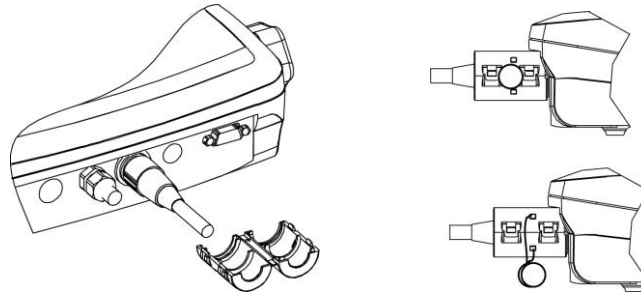

Figure 6-5. T71P Load Cell Sealing Collar

6.3.2 Audit Trail Seal (USA Only)

For jurisdictions that use the audit trail sealing method, the local weights and measures official or authorized service agent must record the current configuration and calibration event counter values at the time of sealing. These values will be compared to values found during a future inspection.

NOTE: A change to an event counter value is equivalent to breaking a physical seal.

The audit trail uses two event counters to record changes to configuration and calibration settings.

- The configuration event counter (CFG) will index by 1 when exiting the menu if one or more of the following settings are changed: Range, Capacity, Graduation, Power On Unit, Zero Range, Auto Tare, Legal for Trade, Stable range, Auto Zero Tracking, Modes, Units, Stable Printing Only. Note that the counter only indexes once, even if several settings are changed. The configuration event counter values range from CFG000 to CFG999. When the value reaches CFG999, the count starts over at CFG000.
- The calibration event counter (CAL) will index by 1 when exiting the menu if a Span Calibration, Linearity Calibration or GEO setting change is made. Note that the counter only indexes once, even if several settings are changed. The calibration event counter values range from CAL000 to CAL999. When the value reaches CAL999, the count starts over at CAL000.

The event counters can be viewed by pressing and holding the MENU button.

0
0.000 kg

While the button is held, the display will show MENU followed by Audit.

MENU

Release the button when Audit is displayed to view the audit trail information.

Audit

The audit trail information is displayed in the format CFGxxx and CALxxx.

CFG000

CAL000

Then the indicator returns to normal operation.

0
0.000 kg

TABLE 6-1. GEOGRAPHICAL ADJUSTMENT VALUES

		Elevation in meters										
		0 325	325 650	650 975	975 1300	1300 1625	1625 1950	1950 2275	2275 2600	2600 2925	2925 3250	3250 3575
		Elevation in feet										
Latitude		0 1060	1060 2130	2130 3200	3200 4260	4260 5330	5330 6400	6400 7460	7460 8530	8530 9600	9600 10660	10660 11730
		GEO value										
0°00'	5°46'	5	4	4	3	3	2	2	1	1	0	0
5°46'	9°52'	5	5	4	4	3	3	2	2	1	1	0
9°52'	12°44'	6	5	5	4	4	3	3	2	2	1	1
12°44'	15°06'	6	6	5	5	4	4	3	3	2	2	1
15°06'	17°10'	7	6	6	5	5	4	4	3	3	2	2
17°10'	19°02'	7	7	6	6	5	5	4	4	3	3	2
19°02'	20°45'	8	7	7	6	6	5	5	4	4	3	3
20°45'	22°22'	8	8	7	7	6	6	5	5	4	4	3
22°22'	23°54'	9	8	8	7	7	6	6	5	5	4	4
23°54'	25°21'	9	9	8	8	7	7	6	6	5	5	4
25°21'	26°45'	10	9	9	8	8	7	7	6	6	5	5
26°45'	28°06'	10	10	9	9	8	8	7	7	6	6	5
28°06'	29°25'	11	10	10	9	9	8	8	7	7	6	6
29°25'	30°41'	11	11	10	10	9	9	8	8	7	7	7
30°41'	31°56'	12	11	11	10	10	9	9	8	8	7	7
31°56'	33°09'	12	12	11	11	10	10	9	9	8	8	7
33°09'	34°21'	13	12	12	11	11	10	10	9	9	8	8
34°21'	35°31'	13	13	12	12	11	11	10	10	9	9	8
35°31'	36°41'	14	13	13	12	12	11	11	10	10	9	9
36°41'	37°50'	14	14	13	13	12	12	11	11	10	10	9
37°50'	38°58'	15	14	14	13	13	12	12	11	11	10	10
38°58'	40°05'	15	15	14	14	13	13	12	12	11	11	10
40°05'	41°12'	16	15	15	14	14	13	13	12	12	11	11
41°12'	42°19'	16	16	15	15	14	14	13	13	12	12	11
42°19'	43°26'	17	16	16	15	15	14	14	13	13	12	12
43°26'	44°32'	17	17	16	16	15	15	14	14	13	13	12
44°32'	45°38'	18	17	17	16	16	15	15	14	14	13	13
45°38'	46°45'	18	18	17	17	16	16	15	15	14	14	13
46°45'	47°51'	19	18	18	17	17	16	16	15	15	14	14
47°51'	48°58'	19	19	18	18	17	17	16	16	15	15	14
48°58'	50°06'	20	19	19	18	18	17	17	16	16	15	15
50°06'	51°13'	20	20	19	19	18	18	17	17	16	16	15
51°13'	52°22'	21	20	20	19	19	18	18	17	17	16	16
52°22'	53°31'	21	21	20	20	19	19	18	18	17	17	16
53°31'	54°41'	22	21	21	20	20	19	19	18	18	17	17
54°41'	55°52'	22	22	21	21	20	20	19	19	18	18	17
55°52'	57°04'	23	22	22	21	21	20	20	19	19	18	18
57°04'	58°17'	23	23	22	22	21	21	20	20	19	19	18
58°17'	59°32'	24	23	23	22	22	21	21	20	20	19	19
59°32'	60°49'	24	24	23	23	22	22	21	21	20	20	19
60°49'	62°09'	25	24	24	23	23	22	22	21	21	20	20
62°09'	63°30'	25	25	24	24	23	23	22	22	21	21	20
63°30'	64°55'	26	25	25	24	24	23	23	22	22	21	21
64°55'	66°24'	26	26	25	25	24	24	23	23	22	22	21
66°24'	67°57'	27	26	26	25	25	24	24	23	23	22	22
67°57'	69°35'	27	27	26	26	25	25	24	24	23	23	22
69°35'	71°21'	28	27	27	26	26	25	25	24	24	23	23
71°21'	73°16'	28	28	27	27	26	26	25	25	24	24	23
73°16'	75°24'	29	28	28	27	27	26	26	25	25	24	24
75°24'	77°52'	29	29	28	28	27	27	26	26	25	25	24
77°52'	80°56'	30	29	29	28	28	27	27	26	26	25	25
80°56'	85°45'	30	30	29	29	28	28	27	27	26	26	25
85°45'	90°00'	31	30	30	29	29	28	28	27	27	26	26

7. MAINTENANCE

7.1 Cleaning



CAUTION: DISCONNECT THE EQUIPMENT FROM AC MAINS POWER BEFORE CLEANING.

T71P

The housing may be cleaned with a cloth dampened with water and a mild detergent. Do not use solvents, chemicals, alcohol, ammonia or abrasives to clean the housing or control panel.

T71XW

The housing may be cleaned with a cleaning solution suitable for use on stainless steel. Rinse the housing with water and dry it thoroughly. Do not use solvents, chemicals, alcohol, ammonia or abrasives to clean the control panel.

7.2 Troubleshooting

TABLE 7-1. TROUBLESHOOTING

SYMPTOM	PROBABLE CAUSE	REMEDY
Will not turn on.	Power cord not plugged in or properly connected. Power outlet not supplying electricity. Battery discharged (T71P). Other failure.	Check power cord connections. Make sure power cord is plugged into the power outlet. Check power source. Replace batteries (T71P). Service required.
Cannot zero the display or will not zero when turned on.	Load on scale exceeds allowable limits. Load on scale is not stable. Load cell damage.	Remove load on scale. Wait for load to become stable. Service required.
Unable to calibrate.	Lock Calibration Menu set to ON. LFT Menu set to ON. Incorrect value for calibration mass.	Set Lock Calibration Menu to OFF. (See Section 3.12) Set LFT Menu to OFF. Use correct calibration mass.
Cannot display weight in desired weighing unit.	Unit not set to ON in Unit Menu.	Enable unit in the Units Menu. (See Section 3.7.)
Cannot change menu settings.	Menu has been locked.	Set selected menu to OFF in the Lock Menu. Lockout Switch on the circuit board may need to be set to the off position.
ERROR 8.1 displayed.	Weight reading exceeds Power On Zero limit.	Make sure scale platform is empty. Perform zero calibration.
ERROR 8.2 displayed.	Weight reading below Power On Zero limit.	Install platform on scale. Perform zero calibration.
ERROR 8.3 displayed.	Weight reading exceeds Overload limit.	Reduce load on scale.
ERROR 8.4 displayed.	Weight reading below Underload limit.	Install platform on scale. Perform zero calibration.
ERROR 8.5 displayed.	Tare out of range	Adjust tare value to be within range

SYMPTOM	PROBABLE CAUSE	REMEDY
ERROR 8.6 displayed.	The weight value cannot be displayed in the current unit of measure because it exceeds 6 digits.	Reduce load on scale until weight value can be displayed. Use a more appropriate unit of measure.
----- displayed.	Busy message. Displayed during tare setting, zero setting, printing	If this message persists, it usually indicates the reading is not stable. Correct the instability.
--NO-- displayed.	The action is not allowed.	Do not attempt this operation.
Battery symbol flashing.	Batteries are discharged.	Replace batteries (T71P). Charge batteries (when optional rechargeable batteries are installed).
CAL E displayed.	Calibration value outside allowable limits.	Use correct calibration weights.
NO LOCK SW displayed.	Attempting to exit the menu with the Legal for Trade setting ON and the security switch OFF.	Set the security switch to the ON position, then exit the menu. (See Section 6.1.)
REF WT ERROR displayed.	Reference Weight too small. The weight on the platform is too small to define a valid reference weight.	Use a greater weight for the sample.

7.3 Service Information

If the troubleshooting section does not resolve your problem, contact an Authorized Ohaus Service Agent. For service assistance in the United States, call toll-free 1-800-526-0659 between 8:00 AM and 5:00 PM Eastern Standard Time. An Ohaus Product Service Specialist will be available to assist you. Outside the USA, please visit our website www.ohaus.com to locate the Ohaus office nearest you.

8. TECHNICAL DATA

8.1 Specifications

The technical data is valid under the following ambient conditions:

Temperature: -10°C to 40°C / 14°F to 104°F

Relative humidity: Maximum relative humidity 80% for temperatures up to 31°C decreasing linearly to 50% relative humidity at 40°C.

Altitude: up to 2000m

TABLE 8-1. SPECIFICATIONS

Indicator Model	T71P	T71XW
Maximum displayed resolution	1:50,000	
Maximum approved resolution	1:10,000	
Maximum counting resolution	1:500,000	
Weighing units	Kilogram, Gram, Pound, Ounce, Pound:Ounce, Tonne, Custom	
Weighing modes	Weighing, Parts Counting, Percent Weighing, Check Weighing, Dynamic Weighing / Display Hold	
Features	Accumulation statistics, Library record storage, Under / Accept / Over LEDs	
Display	25 mm high, 2-line LCD	
Under/Accept/Over indicators	Yellow, Green, Red LED	
Backlight	White LED	
Controls	17 button membrane switch	
Ingress protection	---	IP66
Load cell excitation voltage	5 VDC	
Load cell drive	Up to 8 x 350 ohm load cells	
Load cell input sensitivity	Up to 3 mV/V	
Stabilization time	Within 2 seconds	
Auto zero tracking	Off, 0.5 d, 1 d or 3 d	
Zeroing range	2% or 100% of capacity	
Span calibration	1 kg or 1 lb to capacity	
Housing dimensions (W x D x H)	260 x 71 x 168 mm 10.2 x 2.7 x 6.6 in	262 x 76 x 149 mm 10.3 x 3.0 x 5.8 in
Net weight	1.5 kg 3.3 lb	3.5 kg 7.7 lb
Shipping weight	2.3 kg 5 lb	4.3 kg 9.5 lb
Operating temperature range	-10 °C to 40 °C 14 °F to 104 °F	
Mains power	100-240 VAC / 50-60 Hz internal power supply	
Overvoltage category	II	
Pollution degree	2	
Battery power	6 C-size (LR14) batteries (not supplied) Rechargeable battery pack (option)	Rechargeable battery pack (option)
Interfaces	RS232 (included) External Input (included) Second RS232 (option) RS485/RS422 (option)	

8.2 Accessories and Options

TABLE 8-2. ACCESSORIES

DESCRIPTION	PART NUMBER
Printer STP103, 120VAC US plug	80251992
Printer STP103, 230VAC EU plug	80251993
Printer STP103, 230VAC GB plug	80251994
Printer CBM910, 100VAC JP plug	80252041
Printer CBM910 120VAC US plug	80252042
Printer CBM910 230VAC EU plug	80252043
Interface Cable, Printer CBM910, T71P	80252571
Interface Cable, Printer CBM910, T71XW	80252574
Interface Cable, Printer STP103, T71P	80252581
Interface Cable, Printer STP103, T71XW	80252584
Interface Cable, PC 25 pin, T71P	80500524
Interface Cable, PC 9 pin, T71P	80500525
Interface Cable, PC 9 pin, T71XW	80500552
Interface Cable, PC 25 pin, T71XW	80500553
Load Cell Cable Adapter	80500736
Load Cell Sealing Collar	80500737

TABLE 8-3. OPTIONS

DESCRIPTION	PART NUMBER
Foot Switch	71173378
Alibi Memory Kit	80500503
AC Relay Kit	80500720
Base Mount Kit (T71P only)	80500722
Column Mount Kit, 35 cm painted steel	80500723
Column Mount Kit, 68 cm painted steel	80500724
Column Mount Kit, 35 cm stainless steel	80500725
Column Mount Kit, 68 cm stainless steel	80500726
DC Relay Kit	80500727
Rechargeable Battery Kit	80500729
RS485/RS422 Interface Kit	80500731
RS232 Interface Kit	80500733



Any accessories or options that require the indicator housing to be opened must be installed by a qualified technician.

8.3 Drawings and Dimensions

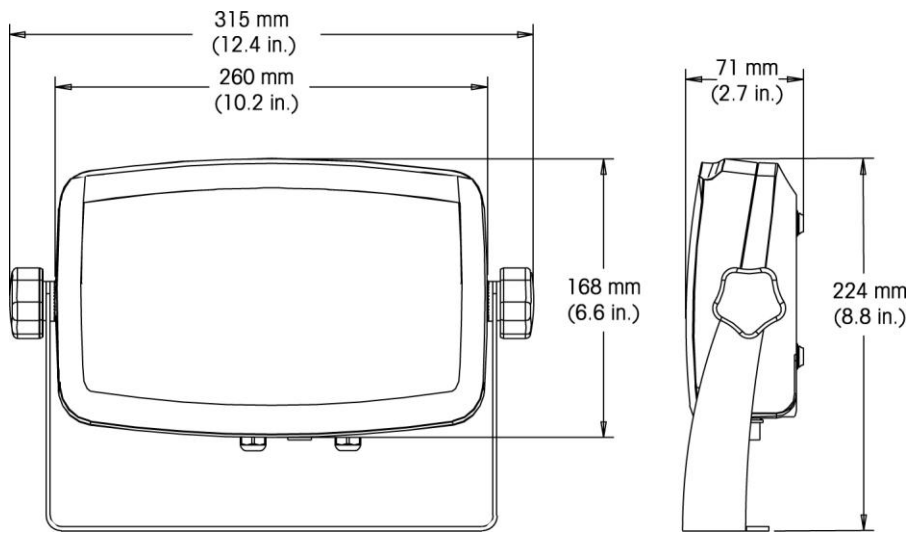

Figure 8-1. T71P Dimensions

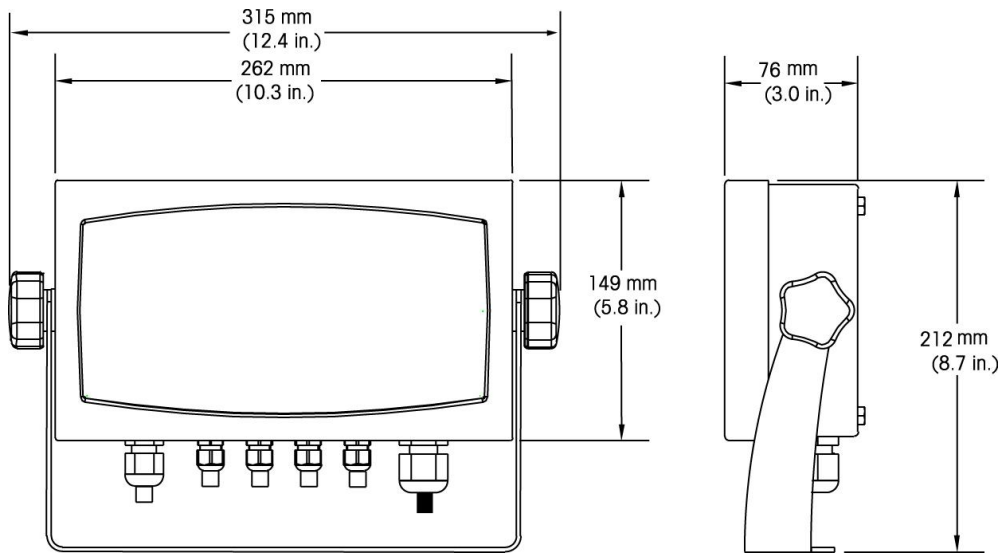





Figure 8-2. T71XW Dimensions

8.4 Compliance

Compliance to the following standards is indicated by the corresponding marking on the product.

Marking	Standard
	This product conforms to the EMC Directive 2004/108/EC, the Low Voltage Directive 2006/95/EC and the Non-automatic Weighing Instrument Directive 2009/23/EC. The complete Declaration of Conformity is available online at www.ohaus.com .
	UL60950-1:2003
	AS/NZS4251.1, AS/NZS4252.1

FCC Note

This equipment has been tested and found to comply with the limits for a Class B digital device, pursuant to Part 15 of the FCC Rules. These limits are designed to provide reasonable protection against harmful interference when the equipment is operated in a commercial environment. This equipment generates, uses, and can radiate radio frequency energy and, if not installed and used in accordance with the instruction manual, may cause harmful interference to radio communications. Operation of this equipment in a residential area is likely to cause harmful interference in which case the user will be required to correct the interference at his own expense.



Industry Canada Note

This Class B digital apparatus complies with Canadian ICES-003.

ISO 9001 Registration

In 1994, Ohaus Corporation, USA, was awarded a certificate of registration to ISO 9001 by Bureau Veritas Quality International (BVQI), confirming that the Ohaus quality management system is compliant with the ISO 9001 standard's requirements. On May 21, 2009, Ohaus Corporation, USA, was re-registered to the ISO 9001:2008 standard.

Important Notice for verified weighing instruments

	Weighing Instruments verified at the place of manufacture bear one of the preceding marks on the packing label and the green 'M' (metrology) sticker on the descriptive data plate. They may be put into service immediately.
	Weighing Instruments to be verified in two stages have no green 'M' (metrology) on the descriptive data plate and bear one of the preceding identification marks on the packing label. The second stage of the initial verification must be carried out by an authorized and certified service organization established within the European Community or by the National Notified Body. The first stage of the initial verification has been carried out at the manufacturer's work. It comprises all tests according to the adopted European Standard EN 45501:1992, paragraph 8.2.2. If national regulations limit the validity period of the verification, the user of the weighing instrument must strictly observe the re-verification period and inform the respective Weights and Measures authority.

**Disposal**

In conformance with the European Directive 2002/96/EC on Waste Electrical and Electronic Equipment (WEEE) this device may not be disposed of in domestic waste. This also applies to countries outside the EU, per their specific requirements.

The Batteries Directive 2006/66/EC introduces new requirements from September 2008 on removability of batteries from waste equipment in EU Member States. To comply with this Directive, this device has been designed for safe removal of the batteries at end-of-life by a waste treatment facility.

Please dispose of this product in accordance with local regulations at the collecting point specified for electrical and electronic equipment.

If you have any questions, please contact the responsible authority or the distributor from which you purchased this device.

Should this device be passed on to other parties (for private or professional use), the content of this regulation must also be related.

For disposal instructions in Europe, refer to www.ohaus.com, choose your country then search for WEEE.

Thank you for your contribution to environmental protection.

LIMITED WARRANTY

Ohaus products are warranted against defects in materials and workmanship from the date of delivery through the duration of the warranty period. During the warranty period Ohaus will repair, or, at its option, replace any component(s) that proves to be defective at no charge, provided that the product is returned, freight prepaid, to Ohaus.

This warranty does not apply if the product has been damaged by accident or misuse, exposed to radioactive or corrosive materials, has foreign material penetrating to the inside of the product, or as a result of service or modification by other than Ohaus. In lieu of a properly returned warranty registration card, the warranty period shall begin on the date of shipment to the authorized dealer. No other express or implied warranty is given by Ohaus Corporation. Ohaus Corporation shall not be liable for any consequential damages.

As warranty legislation differs from state to state and country to country, please contact Ohaus or your local Ohaus dealer for further details.



Ohaus Corporation
7 Campus Drive, Suite 310
Parsippany, NJ 07054, USA
Tel: (973) 377-9000
Fax: (973) 944-7177

With offices worldwide.
www.ohaus.com



P/N 80251405 D © 2011 Ohaus Corporation, all rights reserved.
Printed in China