

MSI9750A

RF Remote Weight Indicator
a component of the **CellScale®** System



**ONLINE PRODUCT
WARRANTY REGISTRATION**
Click here to activate your
MSI Product Warranty today.
www.msiscales.com

User Guide

Measurement Systems International

This Page Intentionally Left Blank



TABLE OF CONTENTS

SECTION 1 – INTRODUCTION & ORIENTATION	4	SECTION 7 – 9750A METER SETUP	35
9750A Keyboard.....	4	System Setup Menu	35
Key Descriptions	5	Set Time & Date	35
9750A Display Symbols	6	Password Locks	36
General Information.....	7	Keyboard Lock	37
Manual & 9750A Conventions	7	Display Setup.....	37
Features.....	8	Single Channel Preset Displays	38
9750A Block Diagram	8	Multi-Channel Preset Displays	39
The CellScale Family	9	Display Setup Menu	39
Unit Installation	10	Using Display Setup	41
Battery Installation.....	10	Custom Display Setup	42
Charger Adapter.....	10	Custom Display Setup Procedure	45
Charging the Battery.....	10	Single Channel Custom Display Menu.....	46
SECTION 2 – RF SCALE COMMUNICATIONS	11	Multi-Channel Custom Display Menu.....	47
FCC Statement.....	11	SECTION 8 – SET POINTS	48
RF Network Description.....	11	Set Point Setup Menu	49
Antennas	11	To Activate/Inactivate all Set Points.....	50
RF Network Setup	12	Program Set Point Menu.....	51
Configuring for multiple networks	12	9750A Set Point Response Menu	51
Troubleshooting RF Connection Problems....	14	Set Point Formula Menu	52
RF Site Testing.....	15	SECTION 9 – COMMUNICATION PORT	53
RF Network Auto Scan.....	15	Cabling.....	53
SECTION 3 – SCALE OPERATION.....	16	Trigger Print.....	53
Power	16	Comm Port Setup Menu	54
Multiple Scale Channels.....	16	Enter / Edit Strings.....	55
Selecting the Active Channel.....	16	General Text Entry.....	56
Select the Display Channel.....	17	Printer Output Formatting.....	58
Multi-Channel Systems	17	End of Line / Start of Line Strings.....	59
Multi-Channel Page Display.....	18	Text / Control Character Entry	59
Zero.....	18	Serial Output “@” Commands	60
Tare	19	SECTION 10 – DATA LOGGING	68
Clear Tare.....	19	Data Logging Setup	68
Setup Tare Mode.....	20	Data Logging Control Menu.....	68
Net/Gross	20	Auto Print to Memory.....	69
Units.....	21	SECTION 11 – TEXT MESSAGING	70
Peak Hold.....	21	Host Message Design	70
Send/Print	21	9750A to Host Message	71
Display Test	21	SECTION 12 – BAR CODE FUNCTIONS	72
SECTION 4 – FUNCTION KEYS	22	Bar Code Setup Menu.....	72
Define Function Keys	22	SECTION 13 – CHANNEL SETUP AND CELLSCALE CALI-	74
Function Key Descriptions	23	BRATION	74
View Function Keys	24	Channel Setup Menu.....	74
Custom Function Key Labels	25	Calibrate General Information.....	75
SECTION 5 – ID CODES	26	Enable Calibration	75
ID Code Organization.....	26	Calibration Procedure	75
Setup ID Codes Menu.....	27	Enable/Disable AZM	76
Using ID Codes.....	28	Motion Band	77
Default ID Code.....	28	Center of Zero Indicator	78
ID Code String 1 & 2.....	29	Motion Compensation Option	78
SECTION 6 – TOTAL / STATISTICS	30	Reset All.....	79
Total	30	Installing Firmware Updates.....	79
Auto Total	30	APPENDIX A – MENU MAPS	82
Setup Total Menu	31	APPENDIX B – ASCII CHART.....	95
Turning Auto Total On & Off	32	APPENDIX C – SPECIFICATIONS & FEATURES	96
View Total & Statistics	32	THE MSI LIMITED WARRANTY	97
Clearing Totals.....	33		
Clear All Totals (All ID Codes at once).....	33		
Statistics.....	33		
View Statistics and Grand Statistics	34		

SECTION 1 – INTRODUCTION & ORIENTATION

INTRODUCTION

The Measurement Systems International MSI-9750A RF Remote Indicator is an accessory component of MSI's CellScale® System. Combined with 1 or more CellScales, the 9750A provides complete control over all scale and data functions. The 9750A serves as a remote terminal for any CellScale and has no internal measurement capability. One 9750A can read the output of many CellScales, and 1 CellScale can also provide data to many 9750's. The backlit, alphanumeric graphic display provides precise, unambiguous indication of operating modes such as Net, Gross, or Total. The 9750A can calibrate a CellScale remotely and provides a user interface to the advanced features of the CellScale. The CellScale system is digitally calibrated from either the 3750CS Indicator, a 9750A Indicator, or with a terminal program hooked directly to the CellScale model 9000. The 9750A combined with a CellScale is designed to meet or exceed the requirements of all regulatory agencies.

9750A KEYBOARD





KEY DESCRIPTIONS



The **POWER** key turns the 9750A On and Off. The **POWER** key must be held for 1 second to ensure startup.



The **ZERO** key is used to zero out residual weight on the scale. When entering numbers or strings the **ZERO** key is used to Clear (delete) characters.



The **TARE** key is used to zero out the weight of containers, trucks, or carriers and to place the scale in the Net weight mode.



The **NET/GROSS** key allows the operator to alternate the weight display from Net (Tared) weight to Gross weight. In some Legal-for-trade jurisdictions, the Gross weight display is limited to 3 seconds.



The **SETUP** key allows entry into the setup submenus. Use this to find menus for setting the Date and Time, setting up the function keys, controlling the display mode and backlight, password locks, calibration, etc.. The key is also used for **ESC**ape. Use **ESC** to return to the previous menu, or display mode.



The **ENTER** key finalizes the entry of numeric or alphanumeric text entries. It also provides an alternate way to maneuver through menus combined with the cursor keys. Pressing **ENTER** before certain keys takes you directly into various modes. Pressing **ENTER** before a Function key enacts the alternate Function key mode.



The **ALPHA** key is used during text entries to select upper case, lower case or numbers. Sometimes used for negative.



The numeric keypad provides all numerals and letters for data entry. Submenus provide punctuation and control characters.



The **DISPLAY** key is used to alternate between single channel displays and multiple channel displays. While in the multiple channel display, highlight the desired channel using the numeric keys, then press **DISPLAY** to bring up the large display. This selected channel is the “Active” channel to which all subsequent actions will be applied. Provides the decimal point or period in numeric and text entries. Functions as **EXIT** in menus returning directly to weight display without having to back through all previous menus.



F1 defaults to **TOTAL**. Pressing this key will cause the current weighment to be added to the total register. In Auto-Total modes, the **TOTAL** key turns Auto-total off and on. Up Cursor in menus.



F2 defaults to **CHANNEL**. When the CellScale has more than 1 channel defined in its Scan List, the **CHANNEL** key will select the next active channel in the list. Precede the **CHANNEL** key with a numeric entry (1-32) to switch directly to a channel scan list position. Press **SETUP CHANNEL** for a shortcut to the “Channel Setup Menu”. Left Cursor in menus.



F3 defaults to **SEND/PRINT**. The action of this key is dictated by the Function key menu, but is usually used to send data to the CellScale or one of its hosts. Used for Insert in text and number entry screens.



F4 defaults to **ADDRESS**. The **ADDRESS** key is used to log on to other CellScale Networks. Pressing the **ADDRESS** key alone will change the active network to the next defined Network. Preceding the **ADDRESS** key with a Network number (0-31) will cause the 9750A to log directly on the entered Network, if it exists and is active.



F5 defaults to **VIEW** Σ (total). This key will show the total weight for the current active ID Code. Down Cursor in Menus.



F6 defaults to **ID**. Pressing **ID** will change you to the next defined ID. Right Cursor in menus.

9750A DISPLAY SYMBOLS

The 9750A uses a full dot matrix graphics display which allows 3 sizes of fonts and full use of graphic symbols. On standard single channel and multi-channel displays, certain symbols are used for scale specific indications.



The motion symbol indicates that the weight has not settled within the motion window (usually $\pm 1d$). While this symbol is illuminated, the scale will not zero, tare, or totalize.



Center-of-Zero – Indicates the weight is within 1/4d of zero. In the small font it appears as “>0<”.



The Sigma symbol is used to indicate a total weight



GRS – Abbreviation for Gross Weight



Low Battery Symbol – Appears when approximately 10% of battery life remains. The 9750A places the indicator in various locations depending on the display mode



ton– Indicates US short tons equal to 2000 lb.



tne – Indicates metric tons equal to 1000 kg.



daN – Indicates the force measurement unit dekaNewtons.

----- Dashes indicate data not yet received from the CellScale, or the RF network is disconnected.

Typical weight displays showing the use of common symbols





GENERAL INFORMATION

The 9750A is a versatile indicator capable of displaying many data items. As a member of the CellScale family the 9750A does not stand alone. It is a slave device to a MSI-9000 CellScale. All data displayed on the 9750A is received via RF from a master CellScale. Many menus in the 9750A depend on information from the CellScale. Therefore, turn the CellScale on before using the 9750A.

Due to the high data rates in the CellScale system menus usually respond instantly. However there are times when the CellScale is busy and it will not “service” the 9750A instantly in all circumstances. At these times you may see the word “Pending” or dashes, or data placeholders which will indicate the CellScale has not yet sent the required information. Weight displays have priority and are sent before all text strings are updated (such as channel name, ID name, etc.).

The majority of CellScale installations have only a single scale input. In this case the Multiple Display modes are not needed. However, even with only a single scale input, Math Channels are available which can be applied for specialized applications.

MANUAL & 9750A CONVENTIONS

- 1) Keys used in operations are printed in **GRAY** and capitalized.
- 2) Setup procedures are usually shown with the shortcut method of reaching the menu. All menus can also be reached through the “Setup Select Menu”. Use the **[7]** key to see all available menu choices.
- 3) Screen shots are shown for example. Many screens provide additional information to orient the user to the scale channel, or ID, or selections made. For example, the Function Key Setup menu will show you the current selection for each key. When you change the function, the previous menu changes to reflect your choice.
- 4) If a function key does not work, it is probably because the CellScale is not setup to support the key. For example, if only one channel is defined in the CellScale, pressing the **CHANNEL** key will have no effect. This also applies to the **ADDRESS** key. If only one Network has been defined, the **ADDRESS** key has no other Network to log onto.
- 5) Menu Titles are shown at the top of the LCD screen and are fully capitalized.
- 6) When space permits, selected parameters are shown at the right side fully capitalized.
- 7) Submenus with multiple choices use a highlighted arrow “▶” to indicate current choice(s).
- 8) When in menus, the **ESC** key (same as **SETUP**) drops back one menu level.
- 9) When in Setup Menus, the **DISPLAY** key returns you directly to the Weight Display (Exit mode).
- 10) Cursor Keys (alternate functions of F1, F2, F5 and F6) only function in menus. Use the DOWN (**v**) cursor key to enable the cursors then use the UP (**^**) or DOWN (**v**) cursor to select line items. Use, **ENTER**, LEFT (**<**), or RIGHT (**>**) cursor keys to rotate through menu choices or select the associated submenu.
- 11) If a submenu is associated with a menu choice, either highlight the menu choice with the cursor keys and press **ENTER**, or press the numbered key corresponding to the desired menu item.
- 12) If a menu applies to any channel, pressing the **CHANNEL** key will select the next channel in the CellScale’s scan list.
- 13) If a menu applies to any ID, pressing the **ID** key will select the next ID in the CellScale’s ID list.
- 14) To input, for example, an ‘E’, first use the **ALPHA** key to change to alpha mode, then press **[2]** twice. If you need two ‘E’s, pause briefly until the display cursor has moved to the next position, then press **[2]** twice.
- 15) In single display modes, pressing the **ENTER** key highlights the whole display to indicate the next press of a Function key will use the alternate mode (Enter-Function Key).

FEATURES

- Designed to meet or exceed all US and international standards.
- Multiple Customized Display Modes, single channel or multiple channel modes
- Reliable 2.4 GHz Frequency Hopping RF communications. Highly immune to interference and multi-path problems. Range in excess of 500 feet indoors and over 5 miles (line of sight) with proper antennas.
- Each 9750A can act as a terminal for any CellScale. A 9750A can monitor multiple scale channels on a single CellScale, or multiple scales tied to multiple CellScales.
- Store up to 32 per connected CellScale ID Codes with separate Alphanumeric Names, Tare, Mode, and Totals. ID Codes are addressed by any customer given name or number. Two user entered ID data strings are available for each ID code.
- Easy to read annunciation of ID Names and Menu Prompts are provided on the fully customer defined display screen.
- Full RS-232 output formatting offers exceptionally versatile data output. Weight data can be printed in any desired way. The customer can add any alpha characters and/or printer formatting commands; including formatting for Bar Code printers. Bar Code readers can also be attached to the Comm Port.
- Manual or Automatic Data Logging into battery backed memory. Any data can be stored for later downloading into a computer.
- Display illumination uses rugged, long life, LED backlighting coupled with a transfective LCD to provide optimum display contrast under all ambient conditions from full sunlight to total darkness. The backlight automatically turns off and on when needed to conserve battery life.
- NiMH battery pack provides up to 9 hours of continuous operation. The built in charger operates, with the proper adapters, from 90-260 VAC (45-65 Hz), or 12-24 VDC Input (optional Cigarette Lighter Adapter available). Accessory power supplies are available to allow charging from 250 VDC as well.
- Selectable for lb., kg, g, tons, metric tons, ounces, and daN for force measurement (some units and /or units switching may be prohibited in legal for trade units).
- Multi-mode automatic or manual weight totalizing with multiple ID registers.
- Weather resistant sealing ensures reliable operations under harsh conditions. Rugged, gasketed, PVC package is rated to NEMA 3 and IP54.

9750A BLOCK DIAGRAM

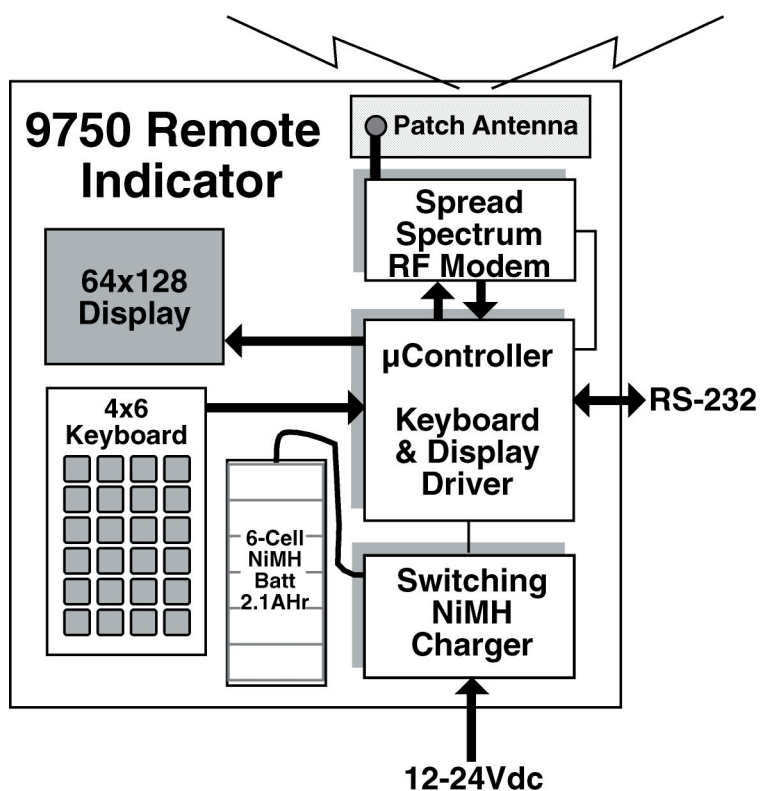

THE CELLSCALE FAMILY

- 1) Model 9000 CellScale – Rugged unit for interfacing any scale and converting it to RF networking.
- 2) Model 9008 Multiplexer – Allows up to eight scales with independent calibrations, to share a single CellScale input channel.
- 3) Model 9020 CellModem – For interfacing peripheral devices to a CellScale.
- 4) Model 3750CS – Fixed mount indicator for CellScales. Capable of control and calibration.
- 5) Model 9750A – Portable remote indicator for CellScales. Capable of control and calibration. Can display multiple channels.
- 6) Model 9300 – CellScale based Crane Scale with local LED display.
- 7) Model 6260CS – CellScale based Crane Scale. Available in standard capacities up to 100000 lb (50000 kg) and by special order up to 250 tons

Model 9260 – (Not pictured) Motion Compensated Crane Scale used in scrap metal weighing.

Model 9002 Summing Box – (Not pictured) Single or Dual Channel summing of up to 4 load cells.



UNIT SETUP

The 9750A is simple to setup and use. If there are no peripheral devices such as a printer or bar code scanner, setup consists of charging the battery, and setting the modem controls to talk to a 9000 CellScale.

BATTERY

The 9750A uses a high capacity Nickel Metal Hydride Rechargeable battery pack. The battery pack will power the 9750A for up to 8 hours depending mainly on how much the LCD backlight is on. This is a custom battery pack with over-temp and over-current protection designed for fast charging that must be replaced with MSI P/N 12431. The battery pack should last over 500 charge cycles. NiMH batteries do not suffer from memory effects and can be charged at any time in the discharge cycle. NiMH batteries do have a fairly high self-discharge rate, so if the unit is unplugged and idle for a long period of time, the batteries will require charging.

The 9750A LCD will display a low battery warning when there is about a half hour to an hour (depends on backlight and battery age) of operating time remaining.

REPLACING THE BATTERY

The 9750A is shipped with the battery pre installed. When the battery needs replacing, remove the 6 screws on the back panel to gain access to the NiMH battery. Gently pull out the battery cable from the interior of the case. There is a single latch on the connector that must be pushed to separate the battery cable from the 9750A. After plugging the new battery in, stuff the connector back into the case interior, then reseal the battery cover.

CHARGER ADAPTER

The 9750A battery charger is integral to the 9750A. Input power can any source of 12-24VDC with a minimum of 20 watts of power. MSI provides two charger sources: 1) Universal AC power: Operates from 86 to 265 VAC 45 to 440 Hz. 2) Vehicle Power: Works with vehicles with 12-24 VDC battery systems (cigarette lighter adapter). The maximum drain on the power source is 20 watts, but this amount of drain is brief. The source current tapers down as the battery charges. For 12V systems the maximum drain is about 1.5 amps. A 5A fuse is sufficient to protect the vehicle electrical system while still providing enough peak power to charge the battery. The MSI Cigarette Lighter Adapter (MSI P/N 12674) is internally fused with a 5A fuse.

CHARGING THE BATTERY

Turn off the 9750A. Plug in the Charger Adapter in the charge port. Charging will take up to 2 hours depending on how much the battery was discharged. The 9750A has a charge status indicator on the front panel. The charger is in fast charge mode when the light is Red. When the light turns Green, the 9750A is ready for use.

Charge Indicator

Off	External Power Not Present
Blinking Red/Grn	Charge Pending. Either the battery temperature is too high, or the cell voltage is below what is safe to fast charge. The battery is trickle charged until these conditions are cleared.
Steady Red	Fast Charge in progress.
Green	Fast Charge Completed. Charger enters pulse phase charge top off. You can use the system as soon as the green light is on. However, maximum charge capacity is reached about 30 minutes after the light turns green. The Green light will pulse often while in top off phase, less often during maintenance phases.



When the battery is new, charge the battery for at least 2 hours initially. Then unplug the adapter, let it cool for 1/2 hour, and then plug it back in. This will initiate another fast charge cycle that should only last a short time if the battery is functioning properly.

The internal charger is a multi-stage charger. The external adapter can be left plugged in indefinitely. It will continually pulse charge the battery preventing self discharge and keeping the battery topped off. If the 9750A is used sporadically, MSI recommends leaving the adapter plugged in while the system is idle.



Do not operate the 9750A with the adapter plugged in. The charger will not charge the internal battery. To ensure fully charging the battery, turn the 9750A off, remove the power plug, then plug it back in.



SECTION 2 – RF SCALE COMMUNICATIONS – THE CELLSCALE SYSTEM

The 9750A is a component of the MSI CellScale System. The CellScale system uses frequency hopping spread-spectrum RF Modem technology transmitting in the 2.4 GHz ISM band.

RF Modems have been problematic as the RF bands are very hostile, corrupted by noise, path loss and interfering transmission from other radios. Even in a pure interference-free environment, radio performance faces serious degradation through a phenomenon known as multipath fading, a problem particularly prevalent for indoor installations. Multipath fading results when two or more reflected rays of the transmitted signal arrive at the receiving antenna with opposing phase, thereby partially or completely cancelling the desired signal. Spread spectrum reduces the vulnerability of a radio system to both interference from jammers and multipath fading by distributing the transmitted signal over a larger region of the frequency band than would otherwise be necessary to send the information. This allows the signal to be reconstructed even though part of it may be lost or corrupted in transit.

Spectrum has been set aside at 2.4 GHz in most countries for the purpose of allowing compliant spread spectrum systems to operate freely without the requirement of a site license. In the USA, there are absolutely no site licensing requirements. The CellScale system is also programmable for use in most European countries. Please contact MSI for worldwide compliance information.

FCC STATEMENT

Note: This unit has been tested and found to comply with the limits for a class A digital device, pursuant to part 15 of the FCC Rules. These limits are designed to provide reasonable protection against harmful interference when the equipment is operated in a commercial environment. This equipment generates, uses, and can radiate radio frequency energy and, if not installed and used in accordance with the instruction manual, may cause harmful interference to radio communications. Operation of this equipment in a residential area is likely to cause harmful interference in which case the user will be required to correct the interference at his own expense. Commensurate with EIRP limits specified in FCC Rules 15.247b, this device may not be used with antennas that exceed 36dB of gain in point-to-point applications or 16dB of gain in multi-point applications. The Transmitter Module is licensed as FCC ID: HSW-2400M.

NETWORK DESCRIPTION

The CellScale system uses frequency hopping which is produced by transmitting the data signal as usual, but varying the carrier frequency rapidly according to a pseudorandom pattern over a broad range of channels, in this case 80 discreet frequencies. These 80 frequencies are combined in different “hopping patterns” to provide 16 separate networks. With minor degradation in channel throughput, this can be doubled to 32 separate networks. The original 16 networks are numbered 00-15, the secondary networks are numbered 16-31. While it is possible to have all 32 networks commingled, some data rate degradation may occur between networks 16 channels apart (e.g. Network 00 and 16, 01 and 17, 02 and 18, etc.), although in most situations this degradation will be unnoticeable.

The CellScale network uses a ‘Star’ network topology. One unit, usually the CellScale, is designated a ‘Master’. The Master transmits a sync pulse on a regular basis, providing synchronization of all remotes in the designated Network. MSI provides five products capable of being the master unit: the CellScale, the Smart CellModem 9000 (not 9020), the MSI-9260 ruggedized Crane Scale, the MSI-9300 Porta-Weigh+ Crane Scale (with local display), or the MSI-6260CS Trans-Weigh CS Crane Scale. Up to 15 slaves can access the master unit. The 9750A is always a ‘Slave’. Multiple 9750A units can coexist on one network, or can be easily switched to other networks as required.

The CellScale system uses CSMA (Carrier sense multiple access) to arbitrate between multiple remotes. CSMA is contention-based. Each remote listens to see if the channel is clear and then transmits. If the channel is not clear, the remote waits a randomly chosen period of time and then tries again. For more on setting up CellScale networks, please refer to the MSI-9000 CellScale User Guide.

ANTENNA

The 9750A uses a built in “Patch” antenna with no external visible element. The patch is located in the end of the 9750A above the display. In most installed CellScale networks, the patch antenna is essentially omnidirectional. However, in systems where the 9750A is reaching the limits of transmission range, the 9750A will achieve better range by pointing it toward the master CellScale’s antenna.

RF NETWORK SETUP

The 9750A is a RF Modem connected device. The RF Modem requires setup to connect to one or more CellScales. The 9750A stores information for all 32 possible networks. Each network setting can be modified with the “Modem Settings Menu”.

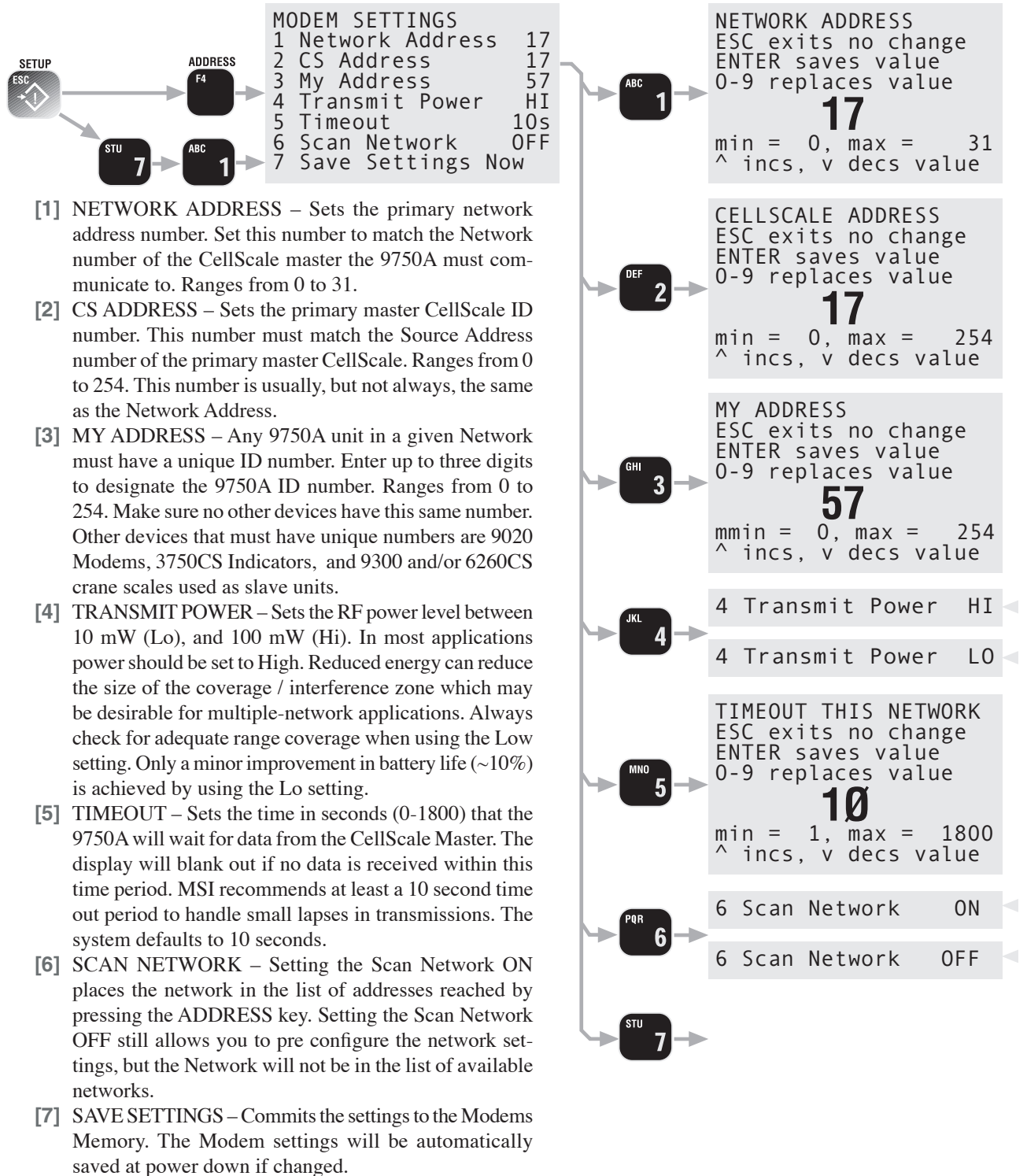



CONFIGURING FOR MULTIPLE NETWORKS

The 9750A can access multiple CellScales by switching Networks. A press of the **ADDRESS** key will change the network allowing the 9750A to monitor and control different scales. Because each CellScale has both a network and a CS address, these must be set up with the “SETUP RF NETWORK” menu and made active. The 9750A can access up to 32 CellScale based Networks. It takes the 9750A from 4 to 8 seconds to switch networks, as it has to sync with a new hopping pattern. Networks that are inactive but were set up can be reached by typing the Network Address (0-31) followed by the **ADDRESS** key. New networks not previously set up can also be reached this way, but the modem configuration will set to defaults.

Setting the Network Address (shortcut method)

Uses Defaults for every setting, and assumes the master CellScale's ID is the same as the Network Address, i.e. 12-12 or 02-02.

- 1) Enter the number of the CellScale network.

In this example we'll use network 12. Use the appropriate numbers for your CellScale master. It is not necessary to enter a '0' for networks below 10.

- 2) Press the **ADDRESS** key. The Network Address Changes to the new Address and is added to the Network Scan List.

It can take up to 8 seconds to log on to a new network, and for the weight data to appear. If the 9750A is unable to locate a Master CellScale at the entered address, the message “NO NETWORK” will appear.

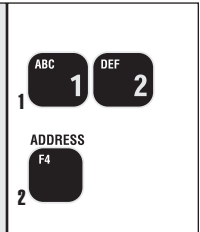

Setting the Network Address (standard method), and RF Modem Configuration

Access to all user configured parameters in the RF Modem.

- 1) Press **SETUP**. From the “SETUP SELECT MENU”, select “MORE” [7].

- 2) Select “RF Modem” [3].

Steps 1 and 2 have a shortcut. Press SETUP followed by ADDRESS.

- 3) Select “Network Address” [1]. This calls the Network Address data entry screen.

- 4) Using the keypad, key in the desired Network Address (0-31). The Address used must match the Network address of the CellScale master. Press **ENTER** to store the address.

- 5) Select “CS Address” [2]. This calls the CellScale Address data entry screen.

- 6) Using the keypad, key in the desired CellScale Address (0-254). The Address used must match the ID address of the CellScale master (2nd number, e.g. xx-12. Usually CellScale masters are configured with the ID Address number matching the Network Address number.

- 7) Select “My Address” [3]. This calls the My Address data entry screen.

- 8) Using the keypad, key in the desired My Address (0-254). The Address used must be unique within all possible networks this 9750A is to contact. Press **ENTER** to store the address.

- 9) Select HI or LO transmit power using the [4] key. Usually this should be set to HI for maximum range.

- 10) Select Timeout [5].

- 11) Using the keypad, set the Timeout in Seconds. A timeout from 5 to 20 seconds is recommended (10 seconds is the default). Press **ENTER** to store the timeout.

- 12) Set this network active by pressing [6]. This places the Network in the 9750's active network list, allowing use of the ADDRESS key to switch the 9750A to this and other stored Modem settings.

- 13) Store the Modem settings by pressing [7]. The unit will pause with a key tone while the settings are stored.

- 14) Return to weight reading (assuming there is a CellScale at the address you just set) by pressing **DISPLAY** or press **ESC** to return to the Setup Menu. There may be a delay while the new address request is processed by the CellScale.

Modem Defaults

CS Address equals entered Network Address (e.g. 12-12, 1-1, 9-9, etc.)

Transmit power set to HI.

Time out set to 10 seconds.

My Address remains unchanged and is the same in any network.

TROUBLESHOOTING RF CONNECTION PROBLEMS

Most connection problems are caused by improperly set up RF Networks. Both the 9750A and the master CellScale unit must have identical Network numbers. In addition, the CS Address must match on both units. If the Network and/or CS Address of the CellScale is in question, you might have to connect a terminal to the CellScale to determine its exact settings. See the CellScale manual for this procedure. Verify the 9750A settings are proper by using the “CONFIGURE RF MODEM” procedure. Each slave device (9750s, 3750CS, and 9020s) must have unique “My Address”.

A common cause of perceived problems is the “Phantom Network”. This occurs when there is a conflicting Network within broadcast range. Multi-CellScale sites must be planned carefully so that there are never two master CellScales on the same Network within range of each other. Since the CellScale can broadcast for miles with good LOS (line of sight) conditions, this consideration is very important. If you suspect your 9750A has locked on to a distant (Phantom) network, try switching both the master CellScale and the 9750A slave to another unused Network. MSI advises avoiding Network #0 when possible, as this is the Modem default, and therefore most likely to be found on units that were left in default settings.

Weight displays, but 9750A keys don't work

This is a result of changing the CS Address in the slave 9750A so it no longer matches the master CellScale. The modem is still registered by the master CellScale, but control codes are not received because the master assumes the codes are intended for a different slave CellScale. Change the CS Address in the 9750A back to the number that matches the master CellScale.

Unit goes in and out of communication

This is usually a result of being in or near an “RF Null” zone. Because of multiple echoes of signals there is sometimes locations that are particularly problematic even for Frequency Hoppers. Usually moving the antenna location even a small distance can clear up this kind of problem. Avoid placing the antenna up against large metal walls. Concrete walls can also be problematic due to their high moisture content. The antenna should be at least 4 inches away from large metal or concrete surfaces. Mounting the antenna too close to a wall has the effect of making the Antenna directional and can attenuate the output.

Range is Inadequate

Antenna placement is the most common cause of poor range. Check that the RF power level of the master and slave units is on “High”. Radio signals in nearby bands that have significant power can also reduce range. Longest range will always be achieved by Line-of-sight (LOS) antenna placement. Any obstacle that interferes with LOS will reduce the range. Significant blocking is caused by metal buildings, solid concrete walls, and any other object that has fairly high electrical conductance. Raising the master antenna higher can help. Just moving the relative antenna placement a short distance might find an RF “path” that will improve distance. The CellScale can sometimes take advantage of reflecting surfaces to get around obstacles. CellScale device antennas should always be placed in vertical polarization; that is the shaft of the antenna should be perpendicular to the earth, not parallel. It is OK to mount the Antenna upside down. This is a good solution when an antenna is mounted on the ceiling for communication with CellScale components in the building. The 9750A internal antenna is mildly directional. Aim the end of the 9750A towards the CellScale master for longest range. In short range applications (LOS and <500 feet) the 9750A is essentially omni-directional.

Some CellScale master units can take advantage of higher gain antennas. Yagi Antennas can greatly improve the range of a CellScale system when installed on the master CellScale. These multi-element antennas are highly directional and must be aimed towards the 9750A area of operation.

The CellScale system is designed using state of the art RF Modems. However there will be conditions and environments where communication of telemetry is sporadic or impossible. Jamming of FHSS systems is difficult, but not impossible. Bear in mind that the most likely source of jamming will be other CellScale systems on the same network, within transmission range. The new breed of wireless phones (not Cell Phones) operating in the 2.4GHz bands will not jam a CellScale. However the CellScale may be received on the wireless phone and will sound like a background ticking noise. Standard Cell Phones do not operate in the same bands as the CellScale and will not interfere with CellScale components. However, a Cell Phone repeater tower nearby might have enough out of band interference to reduce the range of CellScale equipment.



RF SITE TESTING

The 9750A provides a means to check the efficiency of RF transmissions using the RF Site Testing function. Program a function key (use the procedure in Section 4) to “RF Site Testing” to run the test.

- 1) Place the 9750A in close proximity of the master CellScale unit. Make sure communications are good (weight is on the display, all data types have been reported).
- 2) Press the function key programmed for “RF Site Testing”. The bottom right side of the display will read “RF xx%”. The per cent reading indicates the ratio of successful transmissions. It will start low at first, then creep up. It should approach 100%, with an average reading of >96%.
If the reading does not achieve >96% within 1 minute try changing the CellScale Master device (MSI-9000, MSI-6260, MSI-9300, etc.) to a new network. Usually the only thing that will interfere with a CellScale is another frequency hopping modem nearby. Also check your antenna connections on the master.
- 3) Now start walking around the site with the 9750A. If the RF% reading starts down, stop and wait. Aim the 9750A towards the CellScale master and see if the RF% reading begins to rise again. If the display suddenly reads “NETWORK”, you have lost communication. Return to the last place that communications were working and wait for the 9750A to reconnect. In this way you can establish the range of adequate communications, and note any areas with severe RF dropout. The location and height of the CellScale master also plays a big part in range so be sure to run the site test with the CellScale in typical locations used in your application.
- 4) Cancel the RF Site Test by pressing the function key again. If needed for some other function, reprogram the function key.

CELLSCALE NETWORK AUTO SCAN

For installations where multiple CellScale systems are present, the 9750A can scan every network and determine if a CellScale master device is broadcasting. Found CellScales can be copied directly into the RF Scan List at the end of the test. Turn on all CellScale masters (MSI-9000, 6260CS, 9300, etc.) that your 9750A will be used with. Ensure that each CellScale master is on unique network addresses (see product User Guides).

- 1) Press **POWER** followed quickly by **ESC**.
It doesn't matter if the 9750A is on or off.
- 2) Press **NET/GROSS** to start the scan. The 9750A will begin a progressive scan of all 32 networks.
The scan can take as long as 15 minutes. If the backlight times out, press any number key to turn it back on.
- 3) Every CellScale master found will display along with its address. The end of the test will be indicated by the display reading “ENTER Copy to Scan”.
- 4) If you want to store the found CellScale addresses, push **ENTER**. The display will read “COPYING RF SCAN”.
- 5) Press **DISPLAY** to return to weight reading.
You can also press SETUP which will bring up the Setup Menu, or POWER which will turn the 9750A off.

SECTION 3 – SCALE OPERATION

POWER

To Turn On the Power

- 1) Press and hold **POWER** for 1 second. The system Shows the MSI Logo followed by a graphic of a Model 9000 CellScale.
- 2) The LCD then displays “MSI-9750A”, the Network currently loaded as the active Address, and the software version number. The display may read “SCANNING” while establishing communications with the master CellScale.
- 3) Next the RF network is contacted. If the network is functional, the display switches to normal weight display mode. This usually takes 4-15 seconds. If the Network is not available, the screen will continue to display the desired Network. Either change the Scan Network with the **ADDRESS** key or turn on the proper CellScale Master. Use of the **ADDRESS** key assumes that multiple networks have previously set up. See “Setting the Network Address” on page 12.



If the system fails to connect in 8 seconds or less, press the ADDRESS key to select a different Network, or enter the number of a working network and press ADDRESS. If this fails check RF network setups, or decrease the range between the CellScale and the 9750A.

MULTIPLE SCALE CHANNELS

Each CellScale is capable of hosting up to 32 independent scale inputs. Since any 9750A can communicate with any CellScale, theoretically hundreds of scales can be controlled by a single 9750A. Because of the complexities of multiple channel setups, the 9750A is designed to access channels that have been previously setup in the CellScale through its terminal interface or virtual meter interface.

Channels in the CellScale are organized by the A/D input channel followed by a Mux sub channel value. The standard CellScale has two A/D inputs, but can be ordered with four A/D inputs with the addition of a second A/D Converter module. Each A/D channel can be further divided by the use of external multiplexers into eight additional inputs per channel, providing a total of up to 32 independent scale inputs. The channels are designated like this:

Channel (A/D 1-4) → **1** - **1** ← Sub channel (mux 1-8)

The channel will vary from 1-4 and the sub channel from 1-8. In addition the CellScale provides channel 5 for slave CellScales, and channel 6 for math channels. Math Channels allow the user to add or subtract channels from each other or perform other mathematical manipulations of the data. All calibration data for the 32 channels is stored in the CellScale and is independent of the 9750A. Therefore any 9750A can receive calibrated data from any CellScale provided the RF network is set up properly.

It should be noted that sub channels are useful even when the multiplexer option is not used. For example, channel 1-1 could be calibrated as a 1000 x 0.5 kg scale, and channel 1-2 as a 2000 x 1 kg scale, making a dual range platform (of course this assumes the platform is capable of handling 2000 kg). This will work as long as the main channel remains constant. So, in theory, 1 platform could be calibrated as 8 independent scales. This works because the CellScale does not know or care if a Multiplexer is actually present. It treats the input as a separate scale.

The 9750A reads multiple channels by using the Scan list index. The “Scan list” is stored in the CellScale, with up to 32 channels present in the list. The first number in the scan list is called the Scan List Index number. The CellScale can have up to 32 Scan List indices. A scan list can include “Math Channels” which provide a means to digitally add the results of multiple scales.

When dealing with multiple channels it is recommended that you set up the display to always show either the Channel Number or the Channel Name or both. This will help in identifying which scale you are observing.

SELECTING THE ACTIVE CHANNEL

Before standard scale functions are performed, you must select the “Active Channel”. The “Active Channel” is the channel that commands such as Zero, Tare, Total, etc. will be performed on. On single channel display screens, the channel shown is the active channel. On Multiple channel displays, you must highlight the desired channel. This is done with the Cursor Keys. Once highlighted you can perform all the standard scale functions (except Total and View Total, these only work from the single channel display). You can also switch to the single channel display by pressing the **DISPLAY** key.

See the “DISPLAY MODE SETUP” section 7 for information on multiple and single channel weight display modes. For more information on Scan Lists and multiple scale channels, please refer to the CellScale MSI-9000 Users Guide.



TO SELECT THE DISPLAY CHANNEL

As mentioned above, the 9750A will access any channels setup in the CellScale. It does this with the “CHANNEL” function. Use the **CHANNEL** key to step from channel to channel as dictated by the Scan list stored in the CellScale. If the CellScale has only one scale channel defined, only 1 display mode is necessary. This is usually the case for MSI-6260CS, MSI-9300 Crane Scales, and other single load cell systems. However, even single load cell systems can have math channels defined to add functionality.

For systems with multiple scales attached to any given CellScale the setup procedure is:

- 1) Program the CellScale Scan List as required (see the CellScale Manual). It is recommended that each channel is assigned a channel name to aid in identifying the scale in various display modes.
- 2) Optional, but recommended so you can readily identify which scale you are monitoring and controlling – Program the display mode to show the Channel Name, or Channel Number, or both with the Display Setup procedures in Section 7.

To Change the Scale Channel (Single Channel Display)

This example assumes F2 is in its default mode CHANNEL.

- 1) Press the **CHANNEL** key [F2]. The weight display will temporarily display dashes while it queries the CellScale for the next channel information.
- 2) Keep pressing the **CHANNEL** key as desired until the channel of interest is displayed.
To go to the previous channel in the list, press the ENTER key followed by the CHANNEL key. (This assumes the default for E2 has not been altered)



To Change the Scale Channel Using Scan List Position (Single Channel Display)

Uses the CellScale's Scan List Index Number to determine which channel to display.

- 1) Using the numeric keys, input the number (1-32) corresponding to the desired channel in the scan list.
This example finds the fourth entry in the scan list. If a requested channel does not exist in the scan list, this procedure is ignored by the CellScale.
- 2) Press the **CHANNEL** key [F2]. The weight display will temporarily display dashes while it queries the CellScale for the desired channel information.

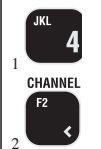

To Change Scale Channel Using the Channel Number (Single Channel Display)

Uses the CellScale's Channel Number to determine which channel to display.

- 1) Using the numeric keys, input the number corresponding to the desired channel number. Use the decimal point as the channel-subchannel separator.
This example finds channel 6-1, a math channel. If a requested channel does not exist in the scan list, this procedure is ignored by the CellScale.
- 2) Press the **CHANNEL** key [F2]. The weight display will temporarily display dashes while it queries the CellScale for the desired channel information.

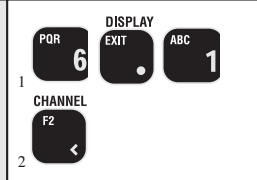

MULTI-CHANNEL SYSTEMS

In CellScale systems with multiple channels, you can choose to see more than one channel at a time (See Display Setup in Section 7). In order to zero, tare, or totalize with channels in a multiple channel display, you must first select the channel to operate on. This is referred to as the “Active” channel, because this is the only channel that any scale function can be performed on.

To Select the Active Channel (multi-channel display)

- 1) Highlight the channel you wish to make Active by pressing the UP (^) or DOWN (v) cursor keys.
- 2) Once highlighted you can Zero the channel, set and clear Tare, and switch between Net and Gross with the **NET/GROSS** key, just press the appropriate key. For Total, View Total, Statistics and other ID functions, you must switch the display to the single channel display by pressing **DISPLAY**.

To Change a Channel in the Multi-Channel Display

- 1) Highlight the channel you wish to change by pressing the UP (^) or DOWN (v) cursor keys.
- 2) Once highlighted enter the scan list position (1-32) or the channel number (1-1 to 6-32 using the decimal point for the sub channel entry). Then press **CHANNEL**.
The new channel replaces the previous channel. If the channel is already on the display in another location, both will display the same information.

To Switch Between Multi-Channel Display and Single Channel Displays

- 1) Highlight the channel you wish to see in the single channel mode by pressing the UP (^) or DOWN (v) cursor keys.
- 2) Once highlighted press **DISPLAY**. The highlighted channel will appear in the single channel mode.
- 3) Perform any scale function while in the single channel mode.
- 4) To return to the multi-channel display, press **DISPLAY**.

Multi-Channel Page Display

When a multi-channel display mode is selected that shows fewer channels than are available from the CellScale, the user can view all channels with the page mode.

Any channel can appear on any page by changing the preset channel using the “To Change Scale Channel...” procedure. This allows a primary channel to show always, and secondary channels to change using the **ALPHA** key. This applies very well to the 3 channel preset display where one channel is large and the other 2 channels are small.

To Change to the Next Page

Press the **ALPHA** key. The next group of channels appears. The action of the **ALPHA** key is circular, returning to page 1 after the last page.

To Copy the Current Page

Sometimes it is advantageous to copy the current page and then make channel changes on the new page.

- 1) Press the **ENTER** key. The entire screen will reverse.
- 2) Press the **ALPHA** key. The new copied page will appear. Make modifications with the enter channel procedures as desired.

To Delete the Current Page

- 1) Press the [0] (SPACE) key.
- 2) Press the **ALPHA** key. The current page will be deleted and the display will revert to the first page.
The 9750A will not allow the deletion of the last remaining page.

To Move Around in Pages

If you have many preset pages, you can move directly to pages by number entry.

- 1) Enter the number corresponding to the page you wish to see.
- 2) Press the **ALPHA** key. The new page will appear.

ZERO

Sets the zero reading of the scale. Use the **ZERO** key to take out small deviations in zero when the scale is unloaded. (See “TARE SET” for zeroing (Taring) package or pallet weights)

To Zero

- 1) In single channel mode, go to step 2. In multi-channel mode, highlight a channel with the up (^) or down (v) cursor keys to make it active.
- 2) Press **ZERO**. The weight reading must be stable within the motion window for the zero function to work. The display temporarily reads “ZEROING” and then “ZEROED” after the CellScale acknowledges the command. The scale digits display 0 (or 0.0 or 0.00, etc..). The backup memory in the CellScale stores the zero reading, and can restore it even if power fails.
The “ZEROING” and “ZEROED” messages may not be displayed on every zero request if the CellScale responds instantly, but the scale will zero.



ZEROING
ZEROED

Zero Rules for Use:

- 1) Works in GROSS mode or NET mode. Zeroing while in Net mode will zero the gross weight causing the display to show the negative Tare value.
- 2) The scale must be stable within the Motion window. The scale will not zero if the motion detect annunciator is on. The CellScale will “remember” that it has a zero request for 2 seconds. If motion clears in that time,



the scale will zero.

- 3) The scale will accept a zero setting over the full Range of the scale (NTEP and other Legal-for-trade models may have a limited zero range). Zero settings above 4% of full scale will subtract from the overall capacity of the scale. For example if you zero out 100 lb. on a 1000 lb. scale the overall capacity of the scale will reduce to 900 lb. plus the allowed over-range amount.

TARE

Tare is typically used to zero out a known weight such as a packing container or pallet and display the load in NET weight. A Tare value is entered in either of two ways:



- 1) **PUSH BUTTON TARE** – When the **TARE** key is pressed, the current weight is zeroed and Net Weight is displayed.
- 2) **KEYBOARD TARE** – Using the numeric keys, the operator keys in the desired Tare Weight then presses the **TARE** Key.

For Pushbutton Tare





<ol style="list-style-type: none"> 1) In single channel mode, go to step 2. In multi-channel mode, highlight a channel with the up (^) or down (v) cursor keys to make it active. 2) Press TARE. The current Gross Weight will be stored in the Tare register and the weight mode will change to NET (single display modes). 	 TARING
---	---

To Clear Tare and Revert to Gross Mode



If the goal is to see the Gross Weight, use the Net/Gross key instead.

<ol style="list-style-type: none"> 1) In single channel mode, go to step 2. In multi-channel mode, highlight a channel with the up (^) or down (v) cursor keys to make it active. 2) Press [0] followed by TARE. The Tare value will clear and the scale returns to the GROSS mode. <i>Alternate method: Remove all weight from the scale (Gross Zero) and press TARE. The message display temporarily reads "TARING". Then the scale returns to the GROSS mode.</i> 	 
--	---

To Keyboard Tare

<ol style="list-style-type: none"> 1) In single channel mode, go to step 2. In multi-channel mode, highlight a channel with the up (^) or down (v) cursor keys to make it active. 2) Using the numeric keys input the value desired. In this example we'll use 0.5 lb. as a Tare Value. Press [0] [.] [5]. The Enter Line displays "0.5". <i>You must place a leading zero if the Tare value is less than 1.</i> 3) Press TARE to place the value in the Tare Register (Current Channel, current ID). The display reads "TARE SET" when the CellScale responds. All subsequent readings have the Tare value subtracted and are displayed in "NET" weight. 	   
--	--

To View the Tare Value

<ol style="list-style-type: none"> 1) In single channel mode, go to step 2. In multi-channel mode, highlight a channel with the up (^) or down (v) cursor keys to make it active. 2) Press ENTER followed by TARE. 3) The display shows the current Tare value <i>Pressing ENTER again allows the Tare value to be edited.</i> 	 
---	---

Tare - Rules for Use:

- 1) Only positive gross weight readings can be tared. Weight can be tared in both the NET and GROSS modes. When in the NET mode, the TARE is not cumulative, all the weight is tared off (to Net zero).
- 2) The motion annunciator must be off. The weight reading must be stable.
- 3) Setting or changing the tare has no effect on the Gross zero setting.
- 4) Taring will reduce the apparent over range of the scale. For example, taring a 10 lb. container on a 60 lb. scale, the scale will overload at a net weight of 50 lb. (60-10) plus any additional allowed overload (usually ~4% or 9d).
- 5) The scale stores the Tare value in the current ID Code memory until cleared. Each available ID Code can store independent Tare values.

Multiple Tare Memories

The 9750A is capable of storing Tare values through the use of the ID Codes. Each ID code stores an independent Tare. See Section 3 “ID Codes” for more information.

SETUP TARE MENU

Programs the automatic TARE Clear function (Auto Clear), and the various Tare Modes including a means to disable Tare.

1-3 AUTO TARE CLEAR

The Auto Tare Clear is intended to automate loading operations where packaging must be tared out, but there is a risk that the operator will forget to re tare each new package. It does this by automatically clearing the tare value and reverting the weight mode back to Gross. The Setup Tare menu permits three modes of Auto Tare Clear: 1) Disabled. 2) Set Clear on Minus - When the Net Weight goes negative (as it will when a tared package is removed), the Tare value is cleared and the weight mode reverts to Gross. 3) Set Clear on Total - When the Total function is enacted, the Tare value is cleared and the weight mode reverts to Gross.

4-5 UNIVERSAL TARE

The Universal Tare feature allows a single Tare value to be shared by all ID Codes. With “Same Tare All IDs” enabled the individual Tares stored with each ID Code are ignored (but not erased). Selecting “Tare by Product ID” will restore the original Tare values. Universal Tare is intended for those applications where a common carrier or pallet is used, but multiple ID Codes are necessary for data collection. To select Universal Tare choose “Same Tare All ID’s” on the TARE SETUP MENU. This effects all IDs on any given scale channel, but not the IDs associated with other scale channels.

Tare Settings Menu

- 1) In single channel mode, go to step 2. In multi-channel mode, highlight a channel with the up (^) or down (v) cursor keys to make it active.
- 2) Standard Method - Press **SETUP**. Select “MORE” [7]. Select “Tare Setup” [6].
Shortcut Method - Press **SETUP** followed by **TARE**.

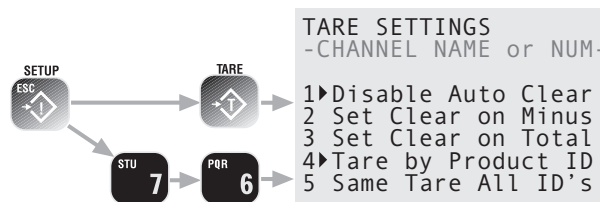

Set Auto Clear Mode with the 1-3 keys. Only 1 item from 1-3 can be enabled at a time. Set the Universal Tare mode with the 4-5 keys.

- 1 Disable Auto Clear – Pressing the [1] key turns off the function (default).
- 2 Set Clear on Minus – When the Net Weight goes negative (as it will when a tared package is removed), the Tare value is cleared and the weight mode reverts to Gross.
- 3 Set Clear on Total – When the Total function is enacted, the Tare value is cleared and the weight mode reverts to Gross.
- 4 Tare by Product ID – Each ID has a unique Tare when this selection is chosen (default).
- 5 Same Tare All ID’s – Pressing the [5] key enables the Universal Tare Mode.

NET/GROSS

Switches the display between Net and Gross modes. Net Weight is defined as Gross Weight minus a Tare Weight.

To Switch Between Net Mode and Gross Mode press the **NET/GROSS** key.

The **NET/GROSS** key will only function if a Tare value has been established for the current channel and the Tare Mode is “NET/GROSS”. The Net/Gross function will affect all meters displaying this channel.

Switching back to Gross mode from Net mode will not clear the Tare value. This allows the operator to use the Gross Mode temporarily without having to reestablish the Tare value. Only manually clearing the Tare or setting a new Tare will change the tare value held before switching into Gross Mode. In displays that include the Net and Gross readings, the NET/GROSS key has no effect since both weight types are already displayed. However, other units displaying just one weight type will change.

OIML Legal-for-trade units only: The NET/GROSS key is temporary action only. The Gross weight is displayed for 2 seconds and then the display returns to the Net Mode. The only way to return to permanent Gross readings is to clear the Tare (see Clear Tare procedure).



UNITS

Allows easy weight units conversions. Up to 8 Units are available. See “SETUP UNITS” in the CellScale Manual for details on activating the available units. Since Units are stored with each ID Code, the menu item for changing units is found in the “Product ID Codes” Menu. See section 3. Alternately, if changing Units is a common operation, a Function key can be programmed for the task. For example, if **F1** is programmed for UNITS, then change the current unit by pressing **F1**. Each subsequent available unit will be found with repeated presses of the **F1** key.

PEAK HOLD (FUNCTION KEY OPTION)

Peak Hold is disallowed in Legal-for-trade systems.

Allows monitoring peak weight. Uses a special mode of the CellScale’s A/D converter for capturing transient events.

To Capture Peak Weight Readings

- 1) Program a **FUNCTION** key for “Toggle Peak Hold” (See Section 4).
- 2) Turn on the Peak Hold mode by pressing the selected **FUNCTION** key. The display reads “PN” for Peak Net readings, or “P” for Peak Gross to indicate peak hold mode is enabled. The display will only update when a greater value than previously recorded is detected.

To Clear Peak Weight Readings

Turn off the Peak mode by pressing the **FUNCTION** key programmed as “Toggle Peak Hold”. The display reverts to Gross or Net and clears the peak value from memory.
Peak Hold captures data at a reading rate set up by the CellScale A/D parameters. For High Speed Peak Hold, use a faster A/D rate. See CellScale Manual.

SEND/PRINT

Sends the current displayed reading to the Comm Port, the Data Logging Memory, or to a remote RF Host. Any or all weight, time, date, and scale parameter functions can be printed as set in the Print Setup Mode (Section 9). The action of the **Send/Print** key is controlled by the function key setup (Section 4).

DISPLAY TEST

Starts a display test to observe all display characters.

To Start the Display Test

- 1) Press the **POWER** key followed quickly by the **ESC** key. The MSI-9750A “Watch Network” screen will appear.
- 2) Press the **TARE** key. The display test will start. Each test screen will last 2 seconds.
- 3) To freeze on any screen, press the **[3]** key. To continue the display test, press **[3]** again.
- 4) To return to the weight mode display, press **EXIT (DISPLAY)** twice.

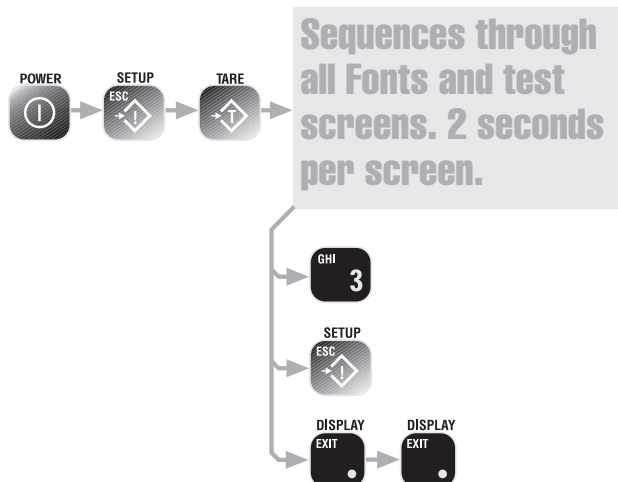

SECTION 4 – FUNCTION KEYS SETUP FUNCTION KEYS

The 9750A has six FUNCTION keys that can be programmed to any of several functions. The default functions are: TOTAL, CHANNEL, SEND/PRINT, ADDRESS, VIEW TOTAL, and ID. These default functions are printed on the front panel. Each key can be programmed for other functions. For example, the TOTAL key can be changed into a UNITS key. Also any of the six keys can be disabled. Each of the six function key can also be assigned a 2nd shifted function. This shifted function is enacted by first pressing the **ENTER** key, followed by the desired function key.

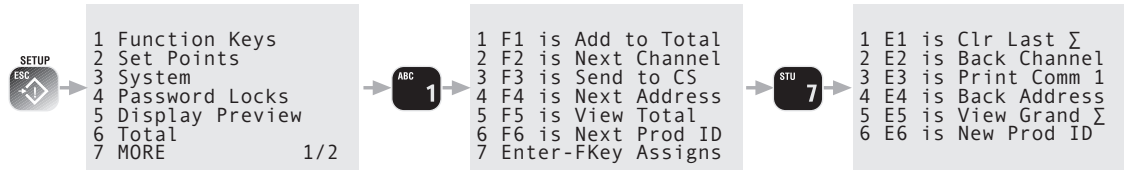

To Define the Function Keys

- 1) Press **SETUP**. The first Setup Menu appears.
- 2) Press [1]. The “FUNCTION KEY ASSIGNS” menu appears. Shown here is the list of all 6 function keys as currently assigned.
- 3) Choose the key you wish to reassign. Make sure you pick a key whose default function is not needed, as defaults are not available for reassignment. In this example we’ll pick F4. This is a logical choice in single systems where only one Network needs to be monitored.
- 4) There are 7 categories of Function Key assignments. Use the [1] - [7] keys to pick the basic category.
- 5) Select a new Function key assignment by selecting the number from 1-7. Selecting a function returns you to the “FUNCTION KEY ASSIGNS” menu with the new choice now shown.

Enter (shifted) F-Keys are assigned in a similar fashion by selecting [7] from the “FUNCTION KEY ASSIGNS” menu.

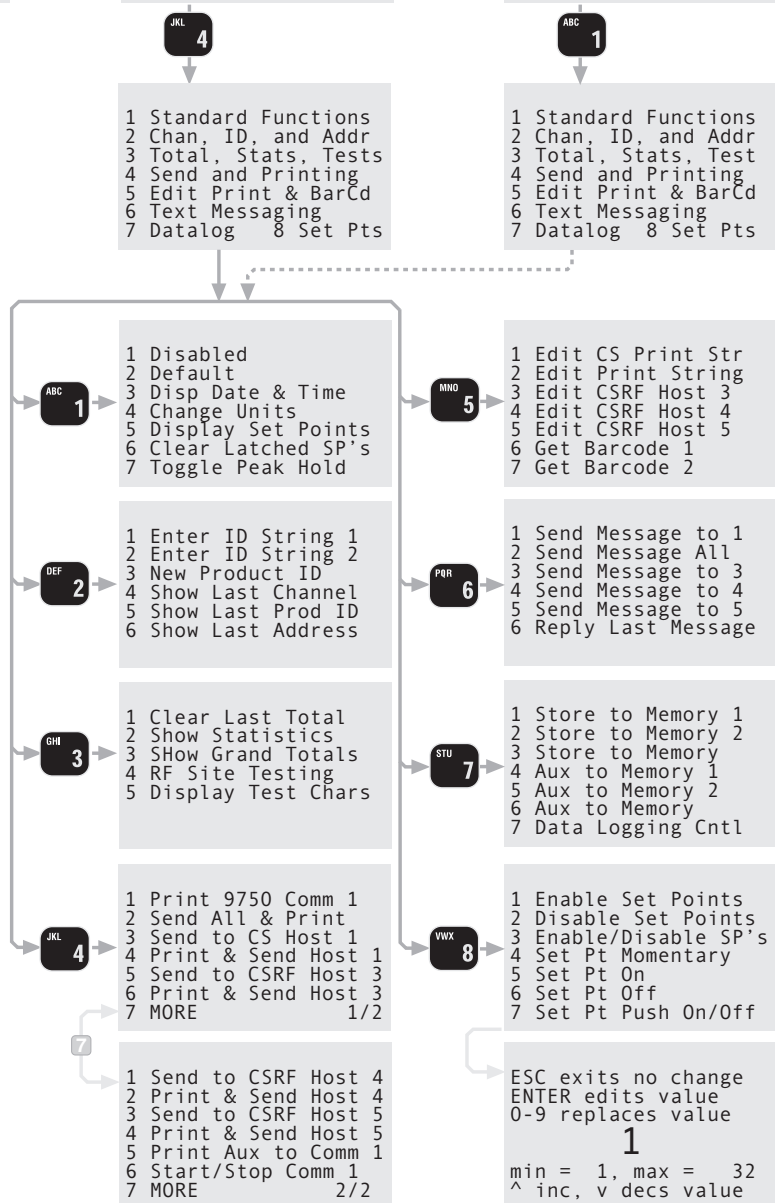



Default Function Keys

- Add to Total**.....Default for F1. Add the current weight to the total, or Auto Total On/Off.
- Channel**.....Default for F2. When pressed, changes to the next channel in the Scan Index. Switch between selected scale channels. If preceded by a number (1-32), the display will show the chosen channel position from the Channel scan list. This always works, even if F2 is programmed for another function.
- Send to CS**.....Default for F3. Causes the Master CellScale to Output text strings to all connected hosts.
- Net Address**.....Default for F4. When pressed, switches to the next available Network Address. When preceded by a number (0-31), will switch directly to the numbered network. This always works, even if F4 is programmed for another function.
- View Total (Σ)**.....Default for F5. Displays totaled weight of the current ID.
- ID Number**.....Default for F6. When pressed, switches to the next available ID Code defined for the Zcurrent channel. When preceded by a number, will switch directly to the numbered ID. This always works, even if F6 is programmed for another function.

1 – Standard Functions Group

- Disabled**.....no function assigned.
- Default**.....set the key as labeled in White for standard Function keys, or the Enter Function key default as listed.
- Disp Date and Time**.....Turns the display into a clock with date. Toggles.
- Change Units**.....1 button access to switching weight units. Available units are defined by the CellScale.
- Display Set Points**.....Observe current status of Set Points. Configure set points.
- Clear Latched SP's**.....Clears any latched Set Point. However, if the Set Point is still triggered this key will not turn it off.
- Toggle Peak Hold**.....Captures maximum readings. Toggles on and off.

2 – Channel, ID, and Address Group

- Enter ID String 1**.....Allows direct entry of ID String 1 which can be used for any text entries.
- Enter ID String 2**.....Allows direct entry of ID String 2 which can be used for any text entries.
- § New Prod ID**.....Default for Enter-F6. Brings up text entry screen. When a name is entered, a new Product ID is created in the connected CellScale (limited to 32 total IDs).
- § Show Last Channel**..Default for Enter-F2. Steps current active channel back one position in the scan list.
- Show Last Prod ID**.....Steps current active Product ID back one position in the Product ID list.
- § Show Last Address**..Default for Enter-F4. Steps current active Network Address back one position in the Network Scan list.

3 – Total, Statistics, and Tests Group

- § Clear Last Total**.....Default for Enter-F1. Clears just the last weight added to the total, and decrements the weighments counter.
- Show Statistics**.....Toggles the Statistics display on and off.
- § Show Grand Totals**...Default for Enter-F5. Toggles the Grand Total display on and off.
- RF Site Testing**.....Used to setup CellScale networks and test for adequate range.
- Display Test Chars**.....Tests the LCD. Displays all programmed fonts and symbols.

4 – Send RF and Printing Group

This group contains two sub-menus. Press [7] to toggle between sub-menus.

- § Print 9750A Comm 1** Default for Enter-F3. Outputs Comm 1 print string to the DE-9 connector.
- Send All & Print**.....Tells the CellScale to output all of its print strings and outputs Comm 1 print string to the DE-9 connector.
- Send to CS Host 1**.....Tells the CellScale to output all of its Host 1 output string (CellScale local Comm Port)
- Print & Send Host 1**.....Outputs Comm 1 print string to the DE-9 connector, and tells the CellScale to output it's Host1 print string.
- Send to CS Host 3**.....Tells the CellScale to output it's Host3 print string.
- Print & Send Host 3**.....Outputs Comm 1 print string to the DE-9 connector, and tells the CellScale to output it's Host3 print string.
- Send to CS Host 4**.....Tells the CellScale to output it's Host1 print string.
- Print & Send Host 4**.....Outputs Comm 1 print string to the DE-9 connector, and tells the CellScale to output

it's Host4 print string.

Send to CS Host 5Tells the CellScale to output it's Host5 print string.

Print & Send Host5Outputs Comm 1 print string to the DE-9 connector, and tells the CellScale to output it's Host5 print string.

Print Aux to Comm 1 ...Sends the Aux string directly to Comm Port 1

Start/Stop Comm 1If the Comm 1 print string is set to an automatic or continuous output mode, this function key will act as a start/stop print key.

5 – Edit Print Strings and Bar Code Group

Edit CS Print String.....Allows direct entry into the Master CellScale Comm 1 print string edit screen. This print string outputs on the CellScale Comm Port 1 connector.

Edit Print StringAllows direct entry into the 9750A Comm 1 print string edit screen. This is the print string used for Data Logging as well as printing out the 9750A Comm Port.

Edit CS Host 3 String ..Allows the 9750A to edit the CellScales RF Host 3 string which is used to communicate with remote modems.

Edit CS Host 4 String ..Allows the 9750A to edit the CellScales RF Host 4 string which is used to communicate with remote modems.

Edit CS Host 5 String ..Allows the 9750A to edit the CellScales RF Host 5 string which is used to communicate with remote modems.

Get BarCode 1Opens Bar Code 1's input entry buffer to receive data from the Comm Port.

Get BarCode 2.....Opens Bar Code 2's input entry buffer to receive data from the Comm Port.

6 – Text Messaging Group

Send Message to 1Sends Message String to CellScale Comm Port 1.

Send Message to AllSends Message String to CellScale Comm Port 1 and to CellScale RF Host 3, 4, and 5.

Send Message to 3.....Sends Message String to CellScale RF Host 3.

Send Message to 4.....Sends Message String to CellScale RF Host 4.

Send Message to 5.....Sends Message String to CellScale RF Host 5.

Reply Last MessageSend Reply to source of last received message.

7 – Data Logging Group

Store to Memory 1.....Outputs Comm 1 print string to data logging memory 1.

Store to Memory 2.....Outputs Comm 1 print string to data logging memory 2.

Store to MemoryOutputs Comm 1 print string to data logging memory 1 or 2 depending on the setting in the Data Logging Control menu.

Aux to Memory 1Outputs the Auxiliary string to data logging memory 1.

Aux to Memory 2Outputs the Auxiliary string to data logging memory 2.

Aux to Memory.....Outputs the Auxiliary string to data logging memory 1 or 2 depending on the setting in the Data Logging Control menu.

Data Logging CntlBrings up the Data Logging control menu for uploading and erasing data.

8 – Set Point Group

Enable Set Points.....Enables the Set Points by F-Key push. Used for Start.

Disable Set Points.....Disables the Set Points by F-Key push. Used for Stop.

Enable/Disable SPs.....Push On/Push Off control of Set Points

Set Pt Momentary.....Enables remote Set Point Relay while being pushed. Sub-menu specifies which Set Point is forced on.

Set Pt On.....Turns remote Set Point Relay on. Specify Set Point in Sub-menu.

Set Pt OffTurns remote Set Pont Relay off. Specify Set Point in Sub-menu.

Set Pt Push On/Off.....Toggles Set Point Relay on/off. Specify Set Point in Sub-menu.

Quick View of Function Keys

The 9750A provides a quick way to view the assigned function keys.

- 1) From any Weight Display press **ENTER** twice. The current assigned function are displayed
- 2) Wait 10 seconds or press **ESC** to return to the weight display.



FUNCTION KEYS			
F1	Total	Channel	F2
F3	Send	Address	F4
F5	View Σ	ID Numbr	F6
ENTER FUNCTION KEYS			
F1	ClrLstΣ	Lastchan	F2
F3	Print	Last Adr	F4
F5	GrandTtl	New ID	F6



Custom Function Key Labels

The “Enter ID String 1” and “Enter ID String 2” function keys provide the user some additional capabilities. When designating a key for these text entry modes, the 9750A brings up a text entry screen that allows you to give a custom 8 character label for the ID String. Once the label is entered, when the Function Key is pressed, the resulting text entry screen will display the custom label. For example, you can program F1 as “Enter ID String 1” and on the text entry screen, type in “Operator”. Now, whenever F1 is pressed, the text entry screen will display “Operator” to show the user what type of data is expected.

In addition, the text entry screen allows you to preprogram what type of data, (numeric, upper case alpha, or lower case alpha) the string will default to, what font size (small, medium, or large), and the screen format (full screen, no menu items, or standard with menu items). Later, when the function key is pressed, the text entry screen will come up in the mode that was set when the label was programmed. This allows you to preset the text entry for numbers only or for text. See “General Text Entry” for details on how to enter strings.

SECTION 5 – ID CODES

- The CellScale can store 32 ID codes. The 9750A controls which ID Code is in use.
- Each ID Code stores a Tare Value, a Total Value, a weighment counter, display mode (Net, Gross, Peak, etc...), Unit (lb., kg, ton, etc.), and two 20 byte ID code strings. Each ID code also computes and stores statistics of Average, Min., Max., Standard Deviation, and Coefficient of Variance.
- ID Codes are created when a new name is entered by the user. The name can be all numbers, all letters, or a combination of numerals and letters. Once the name is entered by the user, the CellScale scans its memory to see if the ID Code already exists. If it does, all new totaled weighments are added to the previously totaled weighments, and any preexisting Tare value will be used for NET weight computation. If the name did not already exist, the CellScale creates a new ID Code.
- ID Codes are alphabetized when created using the standard ASCII convention.
- The 9750A uses the ID function key to scroll through all existing ID Codes as an alternate means of selecting an existing ID code.
- The ID Strings are directly accessible by programming a Function key. The function key label can be customized on the LCD screen to indicate the usage of the string. Use the ID Strings for operator IDs, customer ID, routing numbers, etc..

ID CODE ORGANIZATION

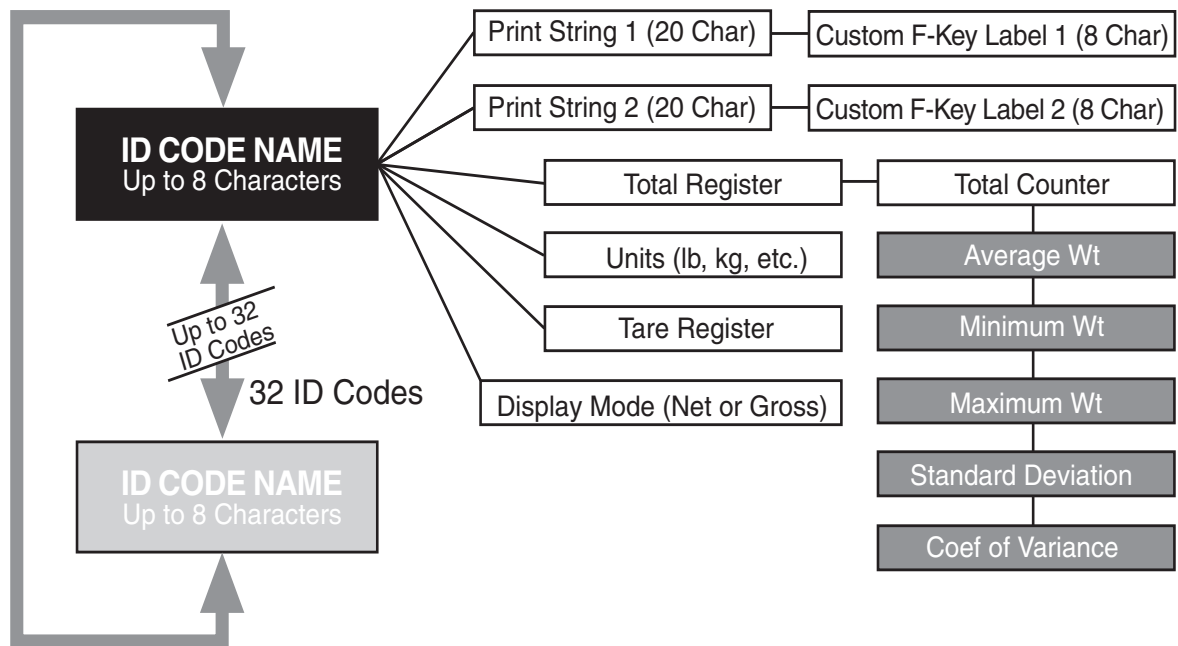



SETUP ID CODES MENU

Allows setup of ID Codes. A new ID can be created, the 8 character ID Name can be edited, two 20 character print strings can be assigned to each ID Code. Also any or all IDs can be deleted from this menu.

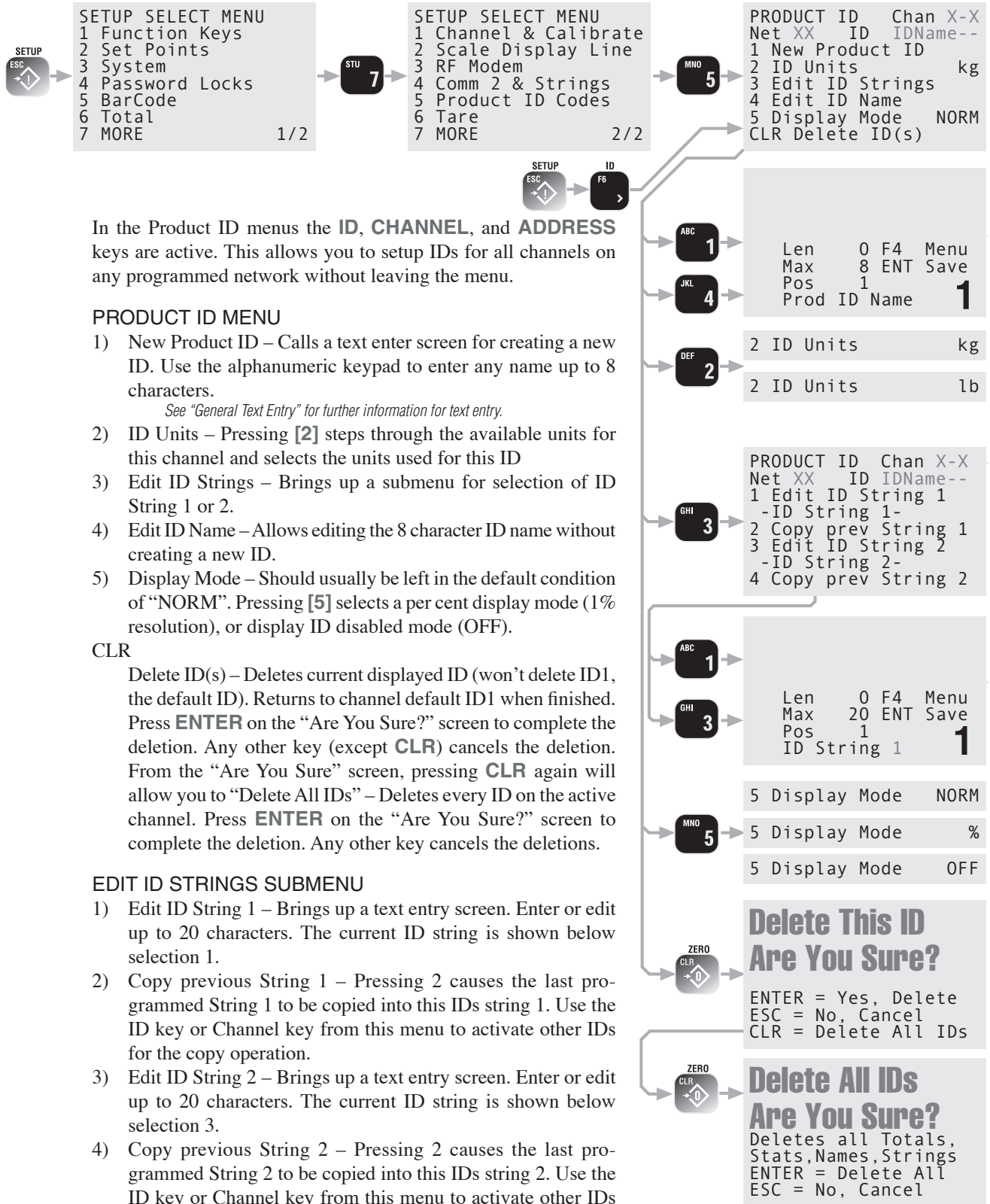

USING ID CODES

To Create a New ID Code (Short method)

This procedure assumes the default for ENTER F6 has not been modified by the user.

- 1) Press **ENTER**, then **ID (F6)**.
- 2) Using the numeric keypad enter a name for the new ID Code. Use the **ALPHA** key to select letters as required.

To Create a New ID Code (Using the Setup ID menu)

- 1) Press **SETUP**, then **ID (F6)** or **SETUP**, “MORE” [7], then “Product ID Codes” [5].
- 2) Select “New Product ID” [1]. This brings up a text entry screen.
- 3) Using the numeric keypad enter a name for the new ID Code. Use the **ALPHA** key to select letters as required.

To Access an Existing ID Code (Scroll through available IDs)

Press **ID (F6)**. Each press of the ID key steps to the next programmed ID on this channel.

To Access an Existing ID Code (find existing ID)

The process of accessing an existing ID Code is identical to the process of creating a new ID Code. When the 9750A detects an ID Code entry it always checks to see if the Code already exists.

- 1) Press **ENTER**, then **ID (F6)**.
- 2) Using the numeric keypad enter the name for the desired ID Code. Use the **ALPHA** key to select letters as required.

To Access an existing ID Code (Using the Setup ID menu)

- 1) Press **SETUP**, then **ID (F6)** or **SETUP**, “MORE” [7], then “Product ID Codes” (5).
- 2) Select “New Product ID” [1]. This brings up a text entry screen.
- 3) Using the numeric keypad enter a name of an existing ID Code. Use the **ALPHA** key to select letters as required. If the CellScale detects a match, the existing ID Code will appear. If not, it will create a new one.

Default ID Code

The 9750A maintains a default ID Code that functions identically to user entered ID Codes except that no name is required. Any totals taken in the default ID Code are included in the grand total. The best way to recognize that the default code is in operation is that it has no ID Code name. The default ID Code can be given a name using “SETUP ID CODES”, but it will not be alphabetized, it will always be first on the list.

The default ID Code is number 1, therefore using the @C command (see section 7) will always start with #2 for user entered ID Codes.

To Scroll through Existing ID Codes

Press **ID (F6)**. All ID codes will appear in order for the selected channel.

To Delete an ID Code

This procedure will delete the current ID and all associated Totals and Statistics. Recall or scroll to the ID Code you wish to delete using either of the two methods detailed previously.

- 1) Using the **ID** key, find the ID Code you want to delete.
- 2) Press **SETUP**, then **ID (F6)**.
- 3) From the “PRODUCT ID” menu select “Delete ID” [CLR].
- 4) From the “Are You Sure” screen press **ENTER** to delete the ID. The Channel will revert to ID1 and the previous ID is now gone. Cancel the delete operation by pressing **ESC (SETUP)** or any key other than **ENTER**.



The following procedure deletes all existing ID Codes and any totals and statistics stored in them.

To Delete all ID Codes

This procedure will delete all the product ID codes and all associated Names, Strings, Totals and Statistics for the current active channel. To delete all product IDs for all channels, you must select a channel using the CHANNEL key, then repeat this procedure for each Channel.

- 1) Press **SETUP**, then **ID (F6)**.
- 2) From the “PRODUCT ID” menu select “Delete ID” [**CLR**].
- 3) From the “Are You Sure” screen press **CLR** to delete the all the product ID. The Channel will revert to ID1 (default ID) and all other IDs are now gone. Cancel the delete operation by pressing **ESC** (Setup) or any key other than **ENTER** or **CLR**.

Memory Full

When all 32 product IDs have been filled, the system will report Memory Full.

ID CODE STRING 1 & STRING 2

Each ID code can be further identified with one or two ID Code Strings. A string is simply a set of alphanumeric characters that can be displayed and/or printed. Each string can be up to 20 characters in length. The MSI “@ codes” can also be embedded in the string which provides an extremely versatile output capability. With @codes the result of the 20 character ID string may be greatly expanded. Also ID strings can be embedded in the main print string to combine them with other data. See Section 7 – Comm Ports, for more details on programming “@ codes”.

Use the ID Code Strings to set up a print string that changes with every ID code. Combined with the standard Comm Port print strings, the ID strings can be used to design a very sophisticated bar code label with three fields that change with every ID Code – the ID Code Name, and ID String 1 and 2.

The Function keys can be programmed to allow one button access to 1 or both ID Strings. This can be used for Operator ID entry, or direct access to the label printer data when the ID string is embedded in the main Comm Port output. Programming a function key for ID String 1 or ID String 2 also allows a text entry to identify the string. For example, you could Label the key for ID String 1 “Operator” and ID String 2 “Customer”. Then by enabling the function key labels, a clear identification of what the strings are for is on the LCD screen.

To Add or Edit an ID Code String

Select the ID Code you wish using the procedure “To Access an Existing ID Code” (previous page)

- 1) Press **SETUP**, then **ID (F6)** or **SETUP**, “MORE” [7], then “Product ID Codes” [5].
- 2) Select “Edit ID Strings” [3].
- 3) Select “Edit ID String 1” (or 2). This brings up a text entry screen.
- 4) Using the numeric keypad enter the ID string (up to 20 characters). Use the **ALPHA** key to select letters as required.
You can embed @codes in the ID string that will be interpreted when printed. However, when displayed on the LCD you'll only see the @code as entered.

To Access the ID Code Strings with the FUNCTION keys

For this procedure to function, a FUNCTION key must be programmed for “Product ID String 1” and/or “String 2”. The key(s) used for this purpose can be labeled to suit your needs (e.g. “CUSTOMER” or “OPERATOR”, etc.) See Section 4– FUNCTION KEY PROGRAMMING for details.

- 1) Press the Function key assigned to the ID string. This brings up a text entry screen.
- 2) Using the numeric keypad enter the ID string (up to 20 characters). Use the **ALPHA** key to select upper case or lower case letters as required.

SECTION 6 – TOTAL / STATISTICS

TOTAL

- The 9750A can add independent weighments together and keep a counter of how many weighments were added (Totaled). The Weighments counter can be thought of as a box or palette counter.
- “TOTAL” always uses the displayed weight, so gross and net readings can be added into the same total.
- There are two modes of Totaling which are set in the SETUP TOTAL section. The Manual mode uses the **TOTAL** key to add the current weight to the previously totaled value. The Auto mode will automatically add the last, settled value to the total (or optionally the highest value). See “SETUP TOTAL” for instructions to enable the AUTO TOTAL modes.
- Both modes have a means to prevent the same load from totaling twice. Once totaled, the load must be removed from the scale before a new load can be added to the Total. Applied weight must be greater than the Total Threshold before it can be totaled. See “SETUP TOTAL” for instructions on how to set the Total Threshold.

To Total with the **TOTAL** Key
(Unit must be setup to Manual Total mode)

Place the weight to be totaled on the scale. When the weight has stabilized, press the **TOTAL** Key [F1]. The current weight is added to the total register. If the display is setup to display the total, the display gives an indication of how many weighments have been totaled. i.e. 6 #. There may be a small delay before the CellScale reports back to the 9750A the new Total and Total weighments.

Rules for use:

- 1) The motion annunciator must be off, the scale must be stable unless motion is disabled in the Setup Total menu.
- 2) Only readings above the High Threshold can be accumulated.
- 3) The scale adds the current reading (relative to the Net zero or Gross zero depending on mode) to the contents of the accumulate register.
- 4) After a weighment is totaled, the weight must go below the Total Threshold before another weight can be added to the total. This assures that a weight on the scale is only added to the total once.

AUTO TOTAL

SETUP Option, see “SETUP TOTAL” to enable Auto Total.

When the weight exceeds the Total Threshold the total function operates automatically.

There are 5 modes of Auto Total. Each mode is used in slightly different ways.

Mode 1, Autonorm: The displayed weight is held in a holding register and added when the weight returns below the Total Threshold. The last settled reading is what will be used for totaling when the scale returns below the Total Threshold. The user must make sure that while removing the load the scale does not stabilize enough for a new reading or an erroneous weighment addition could occur. The last settled weight is actually added to the total when the scale returns to below the Total Threshold.

Mode 2, Autopeak: The “AUTOPEAK” total mode works the same as Autonorm, except that the highest settled reading will be used for totaling on return to zero, rather than the last settled reading.

Mode 3, Autoload: totals the applied weight as soon as the weight is stable (Motion Indicator off). Additional weight cannot be totaled until the weight drops below the Total Threshold

Mode 4, Loaddrop: After pressing the **TOTAL** key, the CellScale starts a long term, motion compensated (if the motion compensation option is installed in the CellScale), average of the current weight that ends when the weight is dropped. This method is designed for commodity weighing of scrap metal, or other types of materials that are loaded into rail cars, trucks, hoppers, etc., usually with a crane.



On Autonorm, Autopeak, and Loaddrop modes, the Total is not recorded until the weight is removed (weight drops below the total threshold). When combining print modes with totals, this can cause the total to lag by one reading. Use the Autoload or Onaccept modes if an immediate current weight and totaled weight printout is required.

Mode 5, Onaccept: In conjunction with target weights set up in the set points menus, the Onaccept total mode will automatically total settled readings that fall within the preselected accept weight window. See Section 8 “Set Points” for information on setting accept limits.



Auto Total Operation

- 1) Enable the desired Auto Total mode in the “SETUP TOTAL” menu (see “SETUP TOTAL”). Select the “AUTONORM”, “AUTOLOAD”, or the “AUTOPEAK” mode. Exit from the setup menu.
- 2) Use the **TOTAL** key to disable (“TTL OFF”) or enable (“TTL ON”) Auto Total.
- 3) Place the weight to be totaled on the scale.
- 4) Remove the weight. The screen will read “TOTALING” briefly, then return to the weight display.

The total key is used as a Total On, Total Off, toggle key which is indicated briefly on the message display (i.e. “TOTAL ON” or “TOTAL OFF”). Auto Totaling will only occur in the TOTAL ON mode. This feature allows the user to turn off Auto Total for periods in which the scale needs to be used without adding to the total. Turning the Auto Total off does not erase the current total. See “To Clear the Total Value” to learn how to erase the Total.

Rules for Auto Total:

- 1) Cannot be in motion. The weight must settle within the motion window.
- 2) Weight readings must be greater than the set High Total Threshold.
- 3) Each reading added to total must be preceded by a return to net or gross zero (below the Low Total Threshold).

SETUP TOTAL MENU

Allows setting Totalizing parameters.

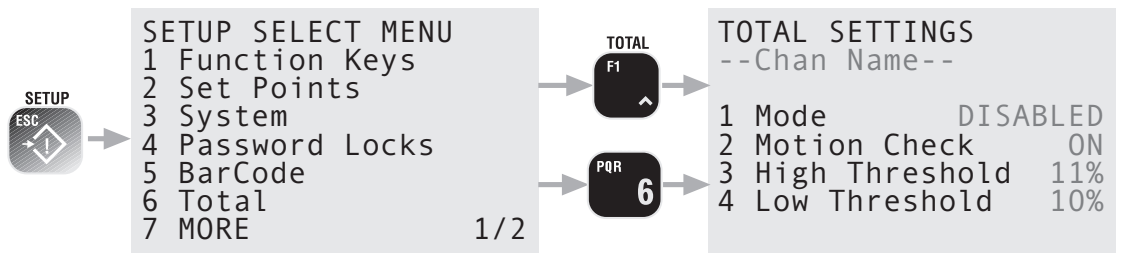

[1] TOTAL MODE – The Manual mode requires that the **TOTAL** key is pressed when the weight currently on the scale should be added to the previously accumulated value. See description on previous page of the 7 total modes.

[2] TOTAL MOTION – Enables or disables Motion Detection for Manual Total. Has no effect on AUTOTOTAL. This menu item controls whether the scale has to be out of motion before it will total. In certain high vibration applications it is sometimes desirable to turn off the motion detect so that Totalizing can occur. This feature is disabled for legal-for-trade systems.

[3] HIGH TOTAL THRESHOLD –

[4] LOW TOTAL THRESHOLD – Sets the weight value above which Totalizing is allowed. For example, setting the high threshold to 10% on a 200 kg scale will set the threshold at 20 kg. Only weight above 20 kg will add to the Total. Once totaled, the weight must return below the Low Threshold to enable the next totalizing. This prevents the same weight from being totaled twice. Another example: On a scale with a capacity of 1000 kg the user desires to Auto Total all weight that exceeds 50 kg. Since 50 kg is 5% of 1000 kg, the Total Threshold is set to 5%. The Threshold is entered in 1% increments.

Minimum Thresholds are 1% for the high, and 0% for the low.

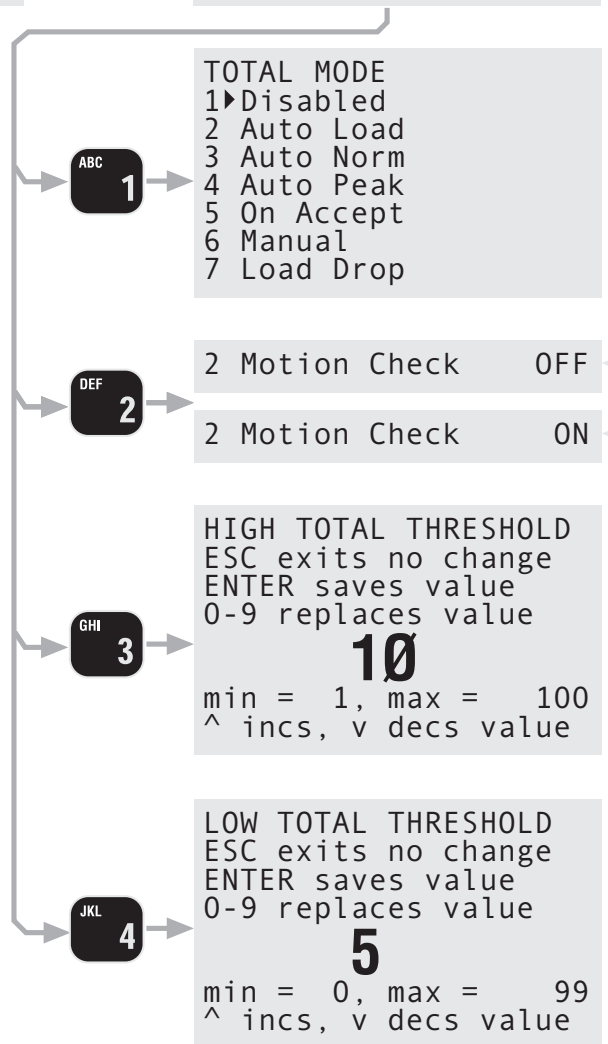

To Set the Total Mode

The following example assumes the F1 function key is in its default mode of "TOTAL".

- 1) Press **SETUP**.
- 2) Press the **TOTAL** switch (**F1**) or select **[6]** Total.
- 3) The current Total Mode is shown on selection 1.
- 4) Press the **[1]** key to bring up the "Total Mode Selection" menu.
- 5) Select the desired Total Mode with the numeric keys (**1-7**). You are returned to the "Total Status" with the new mode indicated on selection 1.
- 6) Motion Setting – If totals are allowed before the scale settles, disable Motion by pressing **[2]**. Disabling Motion should only be used in situations where the weight may never settle. Accuracy will suffer.
Some AutoTotal modes require no motion to function (Auto Load, Auto Norm) and will ignore the setting here. ON means totals will not function until the weight has settled. OFF indicates that motion conditions are ignored.
- 7) Press the **EXIT** key to return to normal scale operation or the **ESC** key to continue in the Setup Menus. Auto Total is now enabled.

To Turn On or Off Auto Total

Turn on or off Auto Totaling by pressing the **TOTAL** key (**F1**). The display will read "TOTAL ON" along with the current total mode, or "TOTAL OFF".

To Set the Total Threshold

- 1) Press **SETUP**.
- 2) Press the **TOTAL** switch (**F1**) or select **[6]** Total.
- 3) Select "High Threshold" by pressing **[3]**.
- 4) Enter the desired high threshold with the numeric keys. Threshold is expressed in per cent of capacity.
- 5) Set the new high threshold by pressing **ENTER**.
If the high threshold you entered was lower than the previous low threshold, the CellScale automatically adjusts the low threshold to be 1% less than the high threshold.
- 6) To change the low threshold, press the **[4]** key.
- 7) Enter the desired low threshold with the numeric keys.
- 8) Set the new low threshold by pressing **ENTER**.
If the low threshold you entered was higher than the previous high threshold, the CellScale automatically adjusts the high threshold to be 1% more than the low threshold.
- 9) Press the **EXIT** key to return to normal scale operation.

VIEW TOTAL

Displays the current Total value of the selected ID and allows the total(s) to be cleared.

The following procedures assume the F5 function key is still in its default "VIEW TOTAL". In any View Total screen, you can change channels by pressing the CHANNEL key. You can change to the next ID by pressing the ID key.

To Display the Current ID#'s Totaled Weight and Statistics

- 1) Press **VIEW** Σ (**F5**). The current IDs total appears on line two, the number of totaled samples on line three, and the ID name (if programmed) on line 1.
- 2) To return to the standard weight display, press **DISPLAY** or **ESC**.

ID NAME	ID#	CH#
	1000.5lb	Σ
	6	#
1 Grand	3 Clr Last	
2 Stats	CLR Delete	

To Erase the last Totaled Weight

If the last totaled (automatic or manual) weight was a mistake, it can be erased with the following procedure. This erases only the last totaled weight.

- 1) Press **VIEW** Σ . The current total is displayed.
- 2) Select "Clr Last" by pressing **[3]**. The "ARE YOU SURE" screen gives an opportunity to change your mind.
- 3) To complete the last totaled weight deletion, press the **ENTER** key.



To Clear the Total Value (Current ID Code only)

At any time during the following procedure the **EXIT** key cancels the Clear operation. Clears ID's statistics registers as well.

- 1) Press **VIEW** Σ . The current total is displayed.
- 2) Press **CLR**. The "ARE YOU SURE" screen gives an opportunity to change your mind.
- 3) To complete the totaled weight deletion, press the **ENTER** key.

To Clear All the Totals and Statistics of all ID Codes at once.

This procedure deletes every totaled weight in every ID code of the current channel. Please make sure all data is recorded as necessary before proceeding.

- 1) Press **VIEW** Σ . The current total is displayed.
- 2) Select "Grand" total by pressing **[1]**.
- 3) Press **CLR**. The "ARE YOU SURE" screen gives an opportunity to change your mind.
- 4) To complete the totaled weight deletion of all current channel ID Codes, press the **ENTER** key.

Clear Last Total

The "Clear Last Total" function key (see Section 4) provides a means to clear just the last totaled data without clearing the entire total register. Use this when a weight is totaled inadvertently or a load drops outside the container, or any other circumstance where just the last total should be deleted from the overall total. "Clear Last Total" is the default mode for **ENTER-F1**.

STATISTICS

Statistics works in conjunction with the Total function and adds MIN, MAX, Average, Standard Deviation, and Coefficient of Variance. All these computations are kept for every ID Code independently. The number of samples that statistics can be calculated for is limited only by memory requirements and will vary from a few thousand to >100000 samples. Individual samples are not stored. If needed, individual samples can be logged through either the RS-232 port or into data logging memory using the "PRINT on TOTAL" function.

A "GRAND TOTAL" function is also included with the Statistics function. The Grand Total adds all the weight in all the ID Codes and provides the following information: GRAND TOTAL, Number of Totals, and the Overall Average (GRAND TOTAL divided by Number of Totals).

Statistics are viewed using the **VIEW TOTAL** key, then selecting "STATS" with the **[2]** key, or program a function key to "Show Statistics".

Definitions and Formulas

AVERAGE – is computed by dividing the total by the number of samples.

MIN – is a single weight register that records the minimum weight that was added to the total.

MAX – is a single weight register that records the maximum weight that was added to the total.

STANDARD DEVIATION – is a measure of how widely values are dispersed from the average value (the mean). The 9750A uses the "non-biased" or "n-1" method that is based on sampling a portion of each available weight. Standard Deviation uses the following formula where x is equal to the total, and n is equal to the number of samples:

$$\sqrt{\frac{n \sum x^2 - (\sum x)^2}{n(n-1)}}$$

COEFFICIENT OF VARIANCE – is a relative dispersion calculated from the sample standard deviation and the mean with the following formula:

$$\frac{100(\text{StdDev})}{\text{Average}} \%$$

GRAND TOTAL – is computed by adding together the totals of all the ID Codes (adjusted to the default unit set in calibration if necessary).

GRAND AVERAGE – is computed by dividing the Grand Total by the number of samples of all the ID Codes.

View Statistics and Grand Statistics

The View Statistics feature uses totaled data from the current ID code in the CellScale to compute statistics. Grand Statistics uses totaled data from all ID codes. Only weight that has been totaled will be used in computing statistics.

- 1) Press **VIEW** Σ (**F5**). The current IDs total appears on the top line, the number of totaled samples on line 2, and the ID name (if programmed) on line 3.
- 2) To see the statistics for the current ID, select "Stats" by pressing **[2]**. When in the Statistics display, return to the Total display by pressing **ESC**, or return to the standard weight display by pressing **DISPLAY**.
- 3) To see the grand total and statistics for all IDs on this scale channel, select "Grand" by pressing **[1]**. When in the Grand Statistics display, return to the Total display by pressing **ESC**, or return to the standard weight display by pressing **DISPLAY**.
- 4) To return to the standard weight display, press **DISPLAY**.

ID NAME	ID#	CH#
	1000.5lb	Σ
	6	#
1 Grand	3 Clr	Last
2 Stats	CLR	Delete

ID Name	ID#	X-X	NET
-Total----		Σ	
-#Samples-		#	
-Minimum-		MIN	
-Maximum-		MAX	
-Average-		AVG	
-Std Dev-		SDV	
-CoefofVar-		CoV	

ID Name	ID#	X-X	NET
-Grand Total-		Σ	
-#Samples-		#	
-GrandMin-		GMN	
-GrandMax-		GMX	
-GrandAvg-		GAV	
-GrandStdDev-		GSD	
-Grand COV-		GCV	



SECTION 7 – 9750A SETUP

SYSTEM SETUP MENU

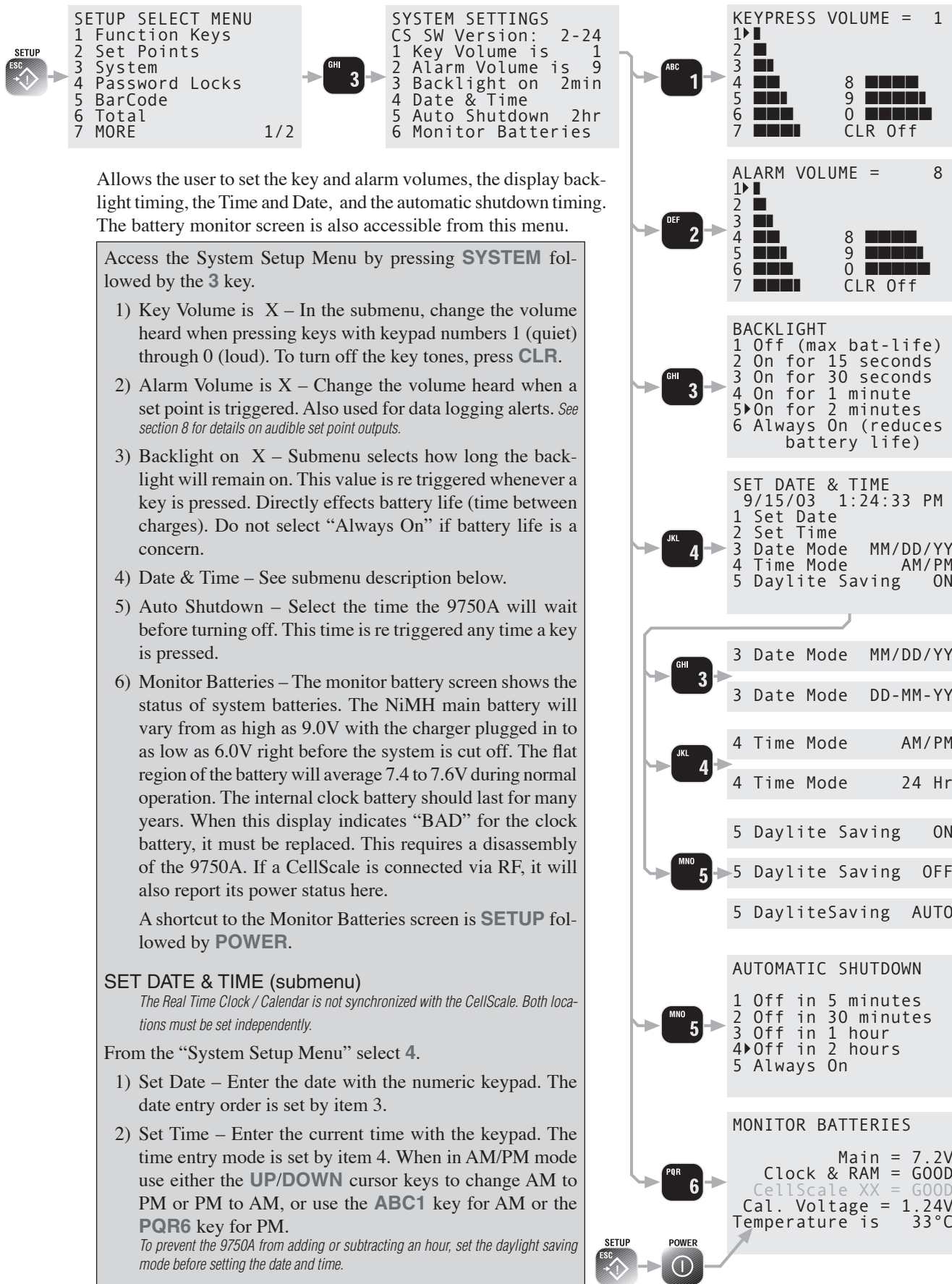

Allows the user to set the key and alarm volumes, the display backlight timing, the Time and Date, and the automatic shutdown timing. The battery monitor screen is also accessible from this menu.

Access the System Setup Menu by pressing **SYSTEM** followed by the **3** key.

- 1) Key Volume is X – In the submenu, change the volume heard when pressing keys with keypad numbers 1 (quiet) through 0 (loud). To turn off the key tones, press **CLR**.
- 2) Alarm Volume is X – Change the volume heard when a set point is triggered. Also used for data logging alerts. See section 8 for details on audible set point outputs.
- 3) Backlight on X – Submenu selects how long the backlight will remain on. This value is re triggered whenever a key is pressed. Directly effects battery life (time between charges). Do not select “Always On” if battery life is a concern.
- 4) Date & Time – See submenu description below.
- 5) Auto Shutdown – Select the time the 9750A will wait before turning off. This time is re triggered any time a key is pressed.
- 6) Monitor Batteries – The monitor battery screen shows the status of system batteries. The NiMH main battery will vary from as high as 9.0V with the charger plugged in to as low as 6.0V right before the system is cut off. The flat region of the battery will average 7.4 to 7.6V during normal operation. The internal clock battery should last for many years. When this display indicates “BAD” for the clock battery, it must be replaced. This requires a disassembly of the 9750A. If a CellScale is connected via RF, it will also report its power status here.

A shortcut to the Monitor Batteries screen is **SETUP** followed by **POWER**.

SET DATE & TIME (submenu)

The Real Time Clock / Calendar is not synchronized with the CellScale. Both locations must be set independently.

From the “System Setup Menu” select 4.

- 1) Set Date – Enter the date with the numeric keypad. The date entry order is set by item 3.
- 2) Set Time – Enter the current time with the keypad. The time entry mode is set by item 4. When in AM/PM mode use either the **UP/DOWN** cursor keys to change AM to PM or PM to AM, or use the **ABC1** key for AM or the **PQR6** key for PM.

To prevent the 9750A from adding or subtracting an hour, set the daylight saving mode before setting the date and time.

- 3) Date Mode – Pressing [3] changes the date mode from MM/DD/YY to DD-MM-YY.
- 4) Time Mode – Press [4] to change between 24 hour time or 12 hour time with AM/PM indication.
- 5) Daylite (sic) Saving – Press [5] to select the Daylight Saving mode. Select “ON” when in Daylight Savings Time (adds 1 hour). Select “OFF” when not in Daylight Savings time. Select “AUTO” to allow the 9750A to automatically enter into and out of daylight savings time (follows US rules). Set the daylight saving mode before setting the date and time.

PASSWORD LOCKS

The Lock function allows the user to lock various setups and or functions to prevent unauthorized changing or erasing of scale functions, features and statistical data. For security a lock password (1-14 characters) is used. Once the MSI 9750A is locked the message “LOCKED” will appear whenever a locked function is tried. To temporarily unlock a function, press any locked key, press **ENTER**, then enter the password followed by the **ENTER** key. To lock or unlock all functions you must use the “PASSWORD LOCKS” menu.

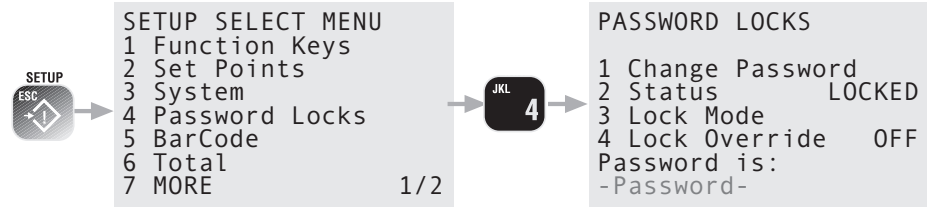

To enter the Password Locks Menu press **SETUP** then [4].

- 1) Change Password – Used to change the password. Pressing [1] brings up a text entry screen. Use the **ALPHA** key and the keypad to input any password. Passwords are case sensitive, so pay attention to upper and lower case characters.
- 2) Status – Pressing the [2] key changes the status from “LOCKED” to “UNLOCKED” to “LOCK ON PWR”. The “LOCK ON PWR” mode leaves the 9750A unlocked until the power has been cycled. This allows the primary operator to complete all setups without having to enter the password over and over. When completely finished with setups, cycle the power and then the lock will be in effect.



Do not forget your password. The only way to unlock a locked system without the proper password is to do a complete reset (RESET ALL), which will cause you to lose all setups. Make a note of it in a secure location.

- 3) Lock Mode – Press the [3] key to select features and functions for password protection. There are 3 submenu select screens. Use the [7] key to scroll through all lockable items. Press the number key beside each item to select it for locking. For example, to lock out the Setup key press [3]. The arrow will appear indicating the Setup Key will lock. After selecting all the lock items, press **SETUP** to return to the “PASSWORD LOCKS” menu.

Tip: Use “Lock All” to lock every lockable feature. Then unlock any features you wish to remain operational. Remember to look at all three screens using the 7 key. The CLR key will unlock all functions while in the Lock Mode menu.

If you forgot your password

MSI provides a master unlock that will erase all operator setups and require you to completely start from scratch. This procedure will not erase calibration, which is stored in the CellScale, not the 9750A. However, all display modes, text strings, system settings, etc., stored in the 9750A, will be lost.

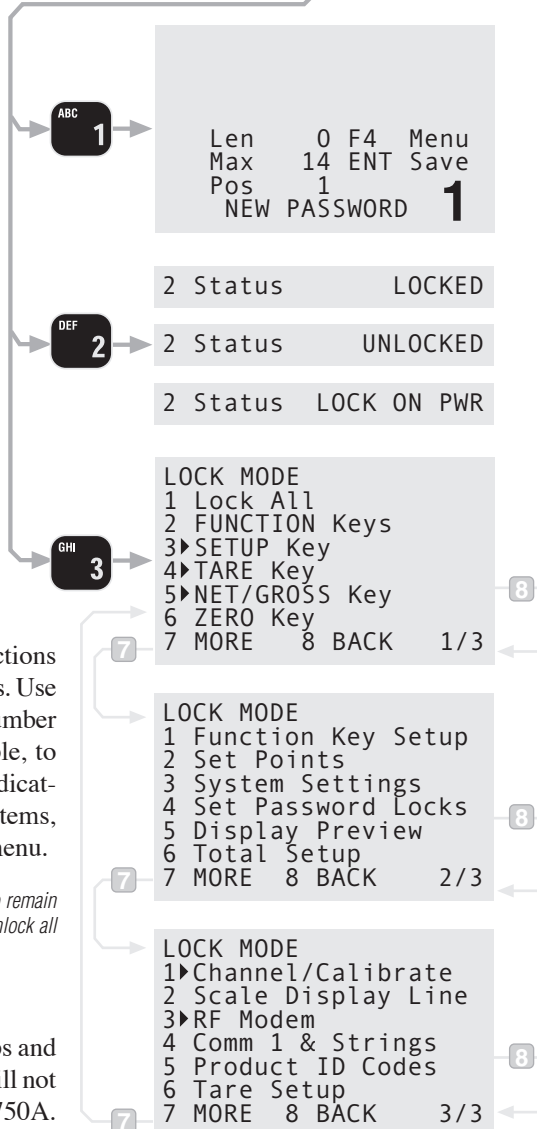



KEYBOARD LOCK

Keyboard lock is provided to prevent casual or accidental pressing of the keys from changing any modes. This function works only from weight display modes.



RESET ALL: The following procedure will cause you to lose all setups and will return the 9750A to its default settings. Use this procedure only as the last resort of having lost your password.

- 1) Press **POWER** followed immediately by **ESC (SETUP)**. The startup screen will appear.
- 2) Press the **CLR (ZERO)** key. A password text entry screen will appear.
- 3) Using the keypad, input the number 7415369. Press **ENTER**.
- 4) The “ARE YOU SURE” display appears. Press **ENTER**.

Everything is reverted to defaults. Now you must setup the 9750A again.

To Lock the Keyboard

Press **[1] [2] [3] ALPHA**. The screen will read “KEYBOARD LOCKED” briefly.

While in Keylock mode, pressing any key will show the screen “KEYLOCK PUSH 123”

To Unlock the Keyboard

Press **[1] [2] [3]**. The screen will read “KEYBOARD UNLOCKED” briefly.

Now all keys should function normally.

DISPLAY SETUP

The 9750A offers the user a great deal of flexibility in how weight and other information is displayed. There are five single channel preset displays and five multiple channel preset displays. These presets cover the majority of user applications. However, the 9750A also allows complete customizing of how scale data is presented on the display.

There are two basic weight display modes, Single Channel, and Multiple Channel. The single channel display is the primary weight display, and is used as the display mode when a channel is highlighted and switched out of the multiple channel display. If your CellScale is equipped with multiple channels, the display can be set up to show up to eight channels at once.

You can access the Display Preview Screen from the main Setup Menu by pressing SETUP and selecting “Preview Display” [5]. The Display Preview shown will depend on the current weight display mode, single or multi-channel.

Preview Screens

When setting up Weight Displays, the 9750A shows a preview of how the screen will be formatted. Abbreviations for preview screens indicate what kind of data will be presented in each screen location. Dashes are used to indicate the maximum screen space the data will occupy.

Preview Screen Nomenclature

- Weight Current Weight in Net or Gross with Units, Motion, and Center of Zero (COZ) indicators.
- Gross-Wt Gross Weight only
- Tare-Wt Tare Weight only
- CHN Channel number in the form X-X. e.g. 1-1. The Channel number is determined by the CellScale Scan List.
- ADR Network Address in the form of XXA. e.g. 17A
- Ch-Name Channel Name. The Channel Name is programmed in the CellScale.
- DateTime Shows the Date and Time. When in the form “DateTimeEnter-Number” it may be overwritten when entering a number with the keypad.
- Enter-Number..... Field accepts keypad entry for assignment to various functions.
- 1-ID-String Show ID string 1.
- 2-ID-String Show ID string 2.
- Total-Wt-ID..... Shows the Total weight stored in the current ID Code.
- #-SamplesI Shows the number of samples totaled and used for statistics for the current ID Code.



Multi-Channel Preset Displays

Multi-channel presets use the scan list position to assign channels to specific locations. After selecting the preset multi-channel display, the user can reassign any channel in the scan list to any screen location.

The Multi-Channel Preset Displays are described by line numbers 1-8 corresponding to the small font layout. The numbers in the sample screens and descriptions correspond to the scan list position index (SLI).

The 9750A reads the scan list out of the master CellScale. If a multi-channel preset is selected that allows more channels than the CellScale has in its scan list, the preset will show just the available channels. If space allows the Date and Time will appear on the bottom line (Line 8).

3's-Weig

```
1's-Weight---- ADR
1's-Ch-Name-----
2's-Weight----
2's-Ch-Name-----
```

3 Ch -1 lg, 2 sm – This display is primarily intended for summing where scan list positions 1 and 2 are scale channels, and position 3 is a math channel that sums the two scale weights. However, any type of channel list can be used with this display and the list order can be changed after this preset is selected. Lines 1-4: SLI 3 large current weight display (-Weight-). Line 5: SLI 1 Current Weight and Network address. Line 6: SLI 1 Channel Name (if programmed in the CellScale). Line 7: SLI 2 Current Weight. Line 8: SLI 2 Channel Name.

1S 1's-Weight----

```
1Ch 1's-IdNm ADR
1's-1-ID-String----
```

2S 2's-Weight----

```
2Ch 2's-IdNm
2's-1-ID-String----
```

2 Ch -2 med+ data – This display shows two channels along with each channels 8 character ID Name and 20 character ID String 1. Lines 1-2: SLI 1 Current Weight preceded by the scan list number. Line 3: SLI 1 Channel Number (e.g. 1-1), SLI 1 ID Name, and the Network Address. Line 4: SLI 1 ID String 1. Line 5-6: SLI 2 Current Weight preceded by the scan list number. Line 7: SLI 2 Channel Number (e.g. 2-1), SLI 2 ID Name. Line 8: SLI 2 ID String 1.

```
1SL 1's-Weight----
1's-Ch-Name-----
2SL 2's-Weight----
2's-Ch-Name-----
3SL 3's-Weight----
3's-Ch-Name-----
4SL 4's-Weight----
4's-Ch-Name-----
```

4 Ch - 4 sm + data – This display shows four channels along with each channels Channel Name. The Channel name must be programmed into the CellScale for it to appear. If less than four channels exist in the scan list, the bottom channel will be replaced with the date/time/enter number line. Line 1: SLI 1 Current Weight preceded by the scan list number. Line 2: SLI 1 Channel Name. SLI 2-4 follow the same format.

1S 1's-Weight----

2S 2's-Weight----

3S 3's-Weight----

4S 4's-Weight----

4 Ch - 4 med – Displays 4 channels in the 9750A medium size font. The weight data is preceded by the scan list position index number (1-32). If less than four channels exist in the scan list, the bottom channel will be replaced with the date/time/enter number line. Lines 1-2: SLI 1 Current Weight preceded by the scan list number. Lines 3-4: SLI 2 Current Weight preceded by the scan list number. Lines 5-6: SLI 3 Current Weight preceded by the scan list number. Lines 7-8: SLI 1 Current Weight preceded by the scan list number.

```
1SL 1's-Weight----
2SL 2's-Weight----
3SL 3's-Weight----
4SL 4's-Weight----
5SL 5's-Weight----
6SL 6's-Weight----
7SL 7's-Weight----
8SL 8's-Weight----
```

8 Ch - 8 small – Maximum channel count display of up to eight channels. Each channel is preceded by the scan list position index number (1-32). If less than eight channels exist in the scan list, the bottom channel will be replaced with the date/time/enter number line.

DISPLAY SETUP MENU

The Display Setup Menu provides access to all the display presets, backlight control, function key displays and full display customizing.

To Enter the Scale Display Setup Menu

- 1) Press **SETUP**. The main Setup Screen appears.
- 2) Press the **DISPLAY** key.

The following describes the various menu item functions and covers the preset single and multi-channel display modes.

SCALE DISPLAY SETUP MENU – PRESET DISPLAYS

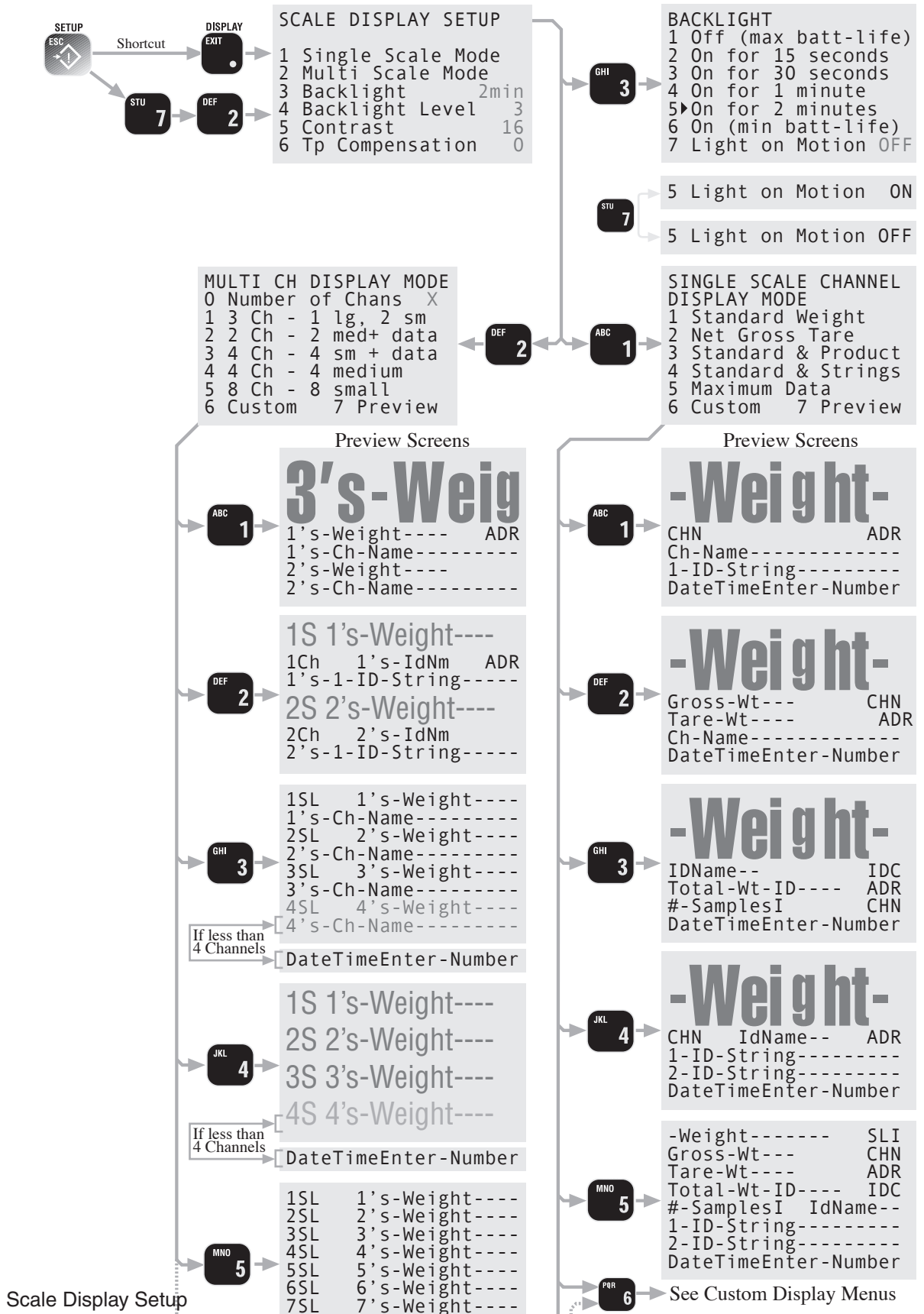

Scale Display Setup

- 1 Single Scale Mode – Accesses single channel display presets and single channel custom menus. The various display modes are described on the previous pages. Press [7] to see a preview of how the single display mode selected will look.
- 2 Multi Scale Mode – Accesses multi channel display presets and multi channel custom menus. The various



display modes are described on the previous page.

- 3 Backlight – Controls the duration of the backlight. The duration resets every time a key is pressed. Setting for shorter times increases battery life.

USING DISPLAY SETUP

The 9750A weight display is a primary means of getting and using CellScale data. The user should always select a single channel weight display mode that provides the information needed. When the CellScale is a multi-channel system, a Multi-Channel display mode should also be selected.

To Set the Single Channel Display Mode (Using Presets)

- 1) Press **SETUP**, then **DISPLAY**. This selects the “SCALE DISPLAY SETUP” menu.
- 2) Select “Single Scale Mode” [1].
- 3) Select the desired preset with the [1]-[5] keys. See “Single Channel Preset Displays” on page 37 for a description of each display mode.
- 4) The display preview appears showing the type and location of data.
- 5) If the display is acceptable, press the **DISPLAY** key to go directly to the selected weight display. If not, press **ESC** and repeat steps 3 to 5.

To Preview the Single Channel Display Mode

- 1) Press **SETUP**, then **DISPLAY**. This selects the “SCALE DISPLAY SETUP” menu.
- 2) Select “Single Scale Mode” [1].
- 3) Preview the current display setting by pressing the [7] key.
- 4) Return to the weight display by pressing the **DISPLAY** key.

To Set the Multi-Channel Display Mode (Using Presets)

- 1) Press **SETUP**, then **DISPLAY**. This selects the “SCALE DISPLAY SETUP” menu.
- 2) Select “Multi Scale Mode” [2].
- 3) Select the desired preset with the [1]-[5] keys. See “Multi Channel Preset Displays” on page 38 for a description of each display mode.
- 4) The display preview appears showing the type and location of data.
- 5) If the display is acceptable, press the **DISPLAY** key to go directly to the selected weight display. If not, press **ESC** and repeat steps 3 to 5.

To Modify the Channel Arrangement

Since the presets use the scan list in ascending order, this procedure provides a means of changing the order or adding channels that don't appear in the first page.

- 1) From the multi-channel weight display, highlight the channel you wish to change by pressing the UP (^) or DOWN (v) cursor keys.
- 2) Once highlighted enter the scan list position (1-32) or the channel number (1-1 to 6-8 using the decimal point for the sub channel entry). Then press **CHANNEL**.
The new channel replaces the previous channel. If the channel is already on the display in another location, both will display.

To Change the Number of Displayed Channels

Setup the display mode before limiting the channels displayed. For example, if you want to show 3 channels on the 4-medium display, select the 4 medium display first, then follow this procedure to reduce the displayed channels down to 3. The maximum number of display channels is set by the display mode.

- 1) Press **SETUP**, then **DISPLAY**. This selects the “SCALE DISPLAY SETUP” menu.
- 2) Select “Multi Scale Mode” [2].
- 3) Select “Number of Channels” [0].
- 4) Input the number of display channels with the [1]-[8] keys. Press **ENTER** to store.
- 5) Press **DISPLAY** to return to the multi-channel display with the number of channels reduced.

CUSTOM DISPLAY SETUP

The 9750A weight display is fully customizable. Both the single channel and multi-channel displays can be customized. All available data types plus custom text can be located anywhere on the screen in any of three font sizes: 1) Large Font – Used primarily for weight displays, the large font offers up to 8 characters in two rows. When used as a weight display the 9750A automatically fits in mode (Net, Gross, Tare), motion, COZ, and units in smaller characters. 2) Medium Font – Used for all data types, the medium font offers up to 16 characters in 4 rows. 3) Small Font – Used for all data types, the small font offers up to 20 characters in 8 rows.

Planning Your Custom Display

Decide what type of data you wish to see and what is the most important data. This important data could be displayed in the large or medium fonts, and other less important data should be displayed in the small font. Use the text mode to label function keys with custom titles to aid in the operation of your system.

For example, use text to label line 7 "F3 Customer" and place ID String 1 next to it. Then use text to label line 8 "F4 Operator" and place ID String 2 next to it. Program the F keys to match. Now you have an easy way to enter your required data.

If your system has multiple channels, make sure you provide both a single channel and multiple channel display setup. In multi-channel displays, it is usually best to supply the same data for each individual channel display similar to avoid confusion. However, if one channel is primary, it is easy to distinguish it by making it larger than other channels. In any multi-channel screen, you can display from 2 to 8 channels, assuming that the CellScale Scan List includes at least 8 channels. CellScales with more than eight channels use the page mode to observe all channels. Select a preset display that is closest to your needs, then edit it. If no preset display is close, use the "CLR Screen" command to start from a completely empty display.

A space is reserved for the enter number field, which can be overwritten with other types of data.

Data Types & Sizes

Type	Lg Font		Med Font		Sm Font		Description
	Min	Max	Min	Max	Min	Max	
Weight	-	8	-	14	-	14	Current Weight in Net or Gross with Units, Motion, and COZ indicators.
Gross-Wt	-	8	-	11	-	11	Gross Weight only
Tare-Wt	-	8	-	11	-	11	Tare Weight only
CHN	-	3	-	3	-	3	Channel number in the form X-X. e.g. 1-1. The Channel number is determined by the CellScale Scan List.
ADR	2	3	2	3	2	3	Network Address in the form of XXA. e.g. 17A
Ch-Name	2	8	2	16	2	20	Channel Name. The Channel Name is programmed in the CellScale.
DateTime	N/A		-	16	-	16	Shows the Date and Time. When in the form "DateTimeEnter-Number" it may be overwritten when entering a number with the keypad.
Date	5	8	5	10	5	10	Date in 5 characters does not include year. In 8 characters includes 2 digit year. In 10 characters includes 4 digit year.
Time	5	8	5	10	5	10	Time in 5 characters does not include seconds. Time in 7 Characters adds AM/PM. Time in 8 characters includes seconds (no AM/PM). Time in 10 characters includes seconds and AM/PM.
1-ID-String	-	8	8	16	8	20	Show ID string 1.
2-ID-String	-	8	8	16	8	20	Show ID string 2.
Total-Wt-ID	-	8	-	15	-	15	Shows the Total weight stored in the current ID Code.
#-SamplesI	-	8	-	10	-	10	Shows the number of samples totaled and used for statistics for the current ID Code.
IDC		2	3	2	3	2	3 The ID Code number in the form xxI. e.g. 2I is ID Code 2.
IDName--	2	8	2	8	2	8	The ID Code name. The name must be programmed by either the CellScale or the 9750A.
xS or xSL	2	3	2	3	2	3	Scan List Index position displayed in the form xSL (positions 1-9) or xxS (positions 10-32).
Grand-Ttl-Wt	-	8	-	15	-	15	Grand Total Weight from all IDs on the active channel.
Gd-Samples	-	8	-	10	-	10	Grand Number of Samples from all IDs on the active channel.
BarCode-String	-	8	8	16	8	20	Bar Code Entry Display
Text	1	8	1	16	1	20	Generic fixed text. Does not change with channels or IDs.



Screen Formatting

The 9750A LCD Screen allows a wide variety of scale display screen setups. The illustrations here demonstrate some of the possibilities. The custom display setup menus control the type and placement of available data types. The LCD is a graphics type organized in rows and columns. The row size is fixed at 8 rows of 8 pixels each for a total vertical size of 64 pixels. Column numbering depends on the font size chosen; 8 columns in the large font, 16 columns in the medium font, and 20 columns in the small font.

	Columns 1-4	Columns 5-8	
Rows	1	2	<p>LARGE FONT – occupies 4 rows and is up to 8 columns wide. Shown here is the maximum characters that can be shown in large font - 2 rows of 8 characters. The full ASCII character set is supported in the large font. Weight displays in the large font add special characters for mode, units, COZ, and motion. All other types of data are limited to 8 characters maximum. The large font can occupy rows 1-4 or 5-8.</p>
	3	4	
	5	6	
	7	8	

	Columns 1-4	Columns 5-8	
Rows	1		<p>Large font characters can also occupy rows 3-6 as illustrated here. However locating large font data on rows 3-6 prevents large font in other rows in the same column.</p>
	2		
	3		
	4		
	5		
	6		
	7		
	8		

	Columns 1-8	Columns 9-16	
Rows	1	2	<p>MEDIUM FONT – occupies 2 rows and is up to 16 columns wide. Shown here is the maximum number of medium characters possible. The medium font must occupy rows 1-2, 3-4, 5-6, or 7-8. You cannot have a medium font that occupies, for example, rows 2 and 3.</p>
	3	4	
	5	6	
	7	8	

	Columns 1-10	Columns 11-20	
Rows	1	2	<p>SMALL FONT – occupies 1 row and is up to 20 columns wide. This allows the most information possible. The small font can start on any row 1-8.</p>
	3	4	
	5	6	
	7	8	

Rows	1	<p>MIXING FONT SIZES – The custom display setup allows the user to mix font sizes as needed. Use the large font for the primary weight display and mix in medium and/or small fonts for less important data. Here are examples of mixing font sizes on the screen. The first screen is an example of a viable weight display with current weight programmed in the large font, occupying rows 1-4. The Gross weight could occupy rows 5-6 in medium font. Other scale information could be placed in small font on rows 7 and 8.</p>
	2	
	3	
	4	
	5	
	6	
	7	
	8	

Rows	1	<p>This example shows using the large font in the middle rows 3-6 and then placing other information above in 2 rows of small font, and below in 1 row of medium font.</p>
	2	
	3	
	4	
	5	
	6	
	7	
	8	

Rows	1	<p>This final example shows the versatility of the setup menus. Here we have small and medium fonts mixed on the same lines, and 1 character of large font (perhaps used to identify the scale being used) placed at column 1 rows 3-6.</p>
	2	
	3	
	4	
	5	
	6	
	7	
	8	

Line Preview

The bottom two lines of the Row Setup menu illustrate what the line has programmed into it. Data is displayed in row pairs. For example, while programming row 6, row 5 and 6 will be illustrated. When data from another line is present, as it will be with the large font, the preview area will show as lines. Diagonal lines are used for the large font (slanted left for top half and right for the bottom half), horizontal lines for medium font, and vertical lines for the small font. If space is available on the requested line, it will show as a blank area. If the occupying text is in the current font choice, you will be able to read the selected data type. In large font the display is in 1/2 scale so that two lines can represent the required 4 lines. In medium font, the double line is represented 1 to 1. In small font, two lines are shown (paired 1-2, 3-4, 5-6, or 7-8) so you see the line you are programming as well as the adjacent line.

When the line is occupied, you have three choices: 1) Pick another line. 2) Delete all data from the line by pressing **CLR**. 3) Delete just the data in the current font from the line by pressing **[0]**. This choice is needed only when there are mixed fonts in the line area.

<p>ROW 1 20 CHARACTERS 1 Product ID 2 Net-Gross-Tare Wt 3 Channel Info 4 Text-Barcode-Misc 5 Date-Time</p> 	<p>This is an illustration of the line preview indicating that the requested row (in this example, row 1) is already occupied by a large font field, and is not available. Pressing CLR will erase whatever is in the location, but it will erase 4 lines since the large font data occupies 4 lines. To identify what is in the location, go back and select the large font entry.</p>
---	--

<p>ROW 1-4 8 CHARACTERS 1 Product ID 2 Net-Gross-Tare Wt 3 Channel Info 4 Text-Barcode-Misc 5 Date-Time</p> <p>-Weight- </p>	<p>Line preview of a large font entry which identifies the data present. This shows (in 1/2 scale) that the current weight display in large font occupies rows 1-4. The left side preview area is equivalent to 1/2 of the whole LCD.</p>
--	---

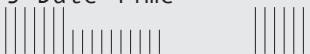
<p>ROW 5-6 16 CHARACTER 1 Product ID 2 Net-Gross-Tare Wt 3 Channel Info 4 Text-Barcode-Misc 5 Date-Time</p> 	<p>Line preview of a medium font entry. There are small font data items on lines 5 and 6, but a gap exist in the middle. This would allow a 4 character medium font entry with the start column at 9 to fit in. If you want to get rid of all data on lines 5-6, just press CLR.</p>
--	---

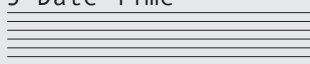
<p>ROW 5 20 CHARACTERS 1 Product ID 2 Net-Gross-Tare Wt 3 Channel Info 4 Text-Barcode-Misc 5 Date-Time</p> 	<p>Line preview of a small font entry to line 5. The horizontal bars indicate that a medium font data entry occupies both line 5 and line 6.</p>
---	--

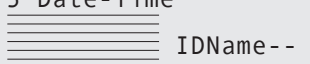
<p>ROW 5 20 CHARACTERS 1 Product ID 2 Net-Gross-Tare Wt 3 Channel Info 4 Text-Barcode-Misc 5 Date-Time</p> 	<p>Line preview of a small font entry to line 5. The horizontal bars indicate that a medium font data entry occupies both line 5 and line 6, but in this case, only to the middle of the screen. Therefore a small font entry can be placed on line 5 with a start point at column 11, which allows data with up to 10 characters. This screen also shows, for example, that on line 6, the IDName field is there starting at column 12.</p>
---	--



Selecting Items for Display

The custom display setup menus provide access to all the data the scale can provide. When an item is present on the display, it will have an arrow next to its selection number. The length of some data items are fixed, but many have variable lengths. When an item is selected for the first time, a number entry screen will appear (if it is a variable length data item) allowing you to decide the length of the data. Beneath each item is the “Column Start” selection which allows you to change the starting location. The 9750A adjusts the available start column range in order to allow the whole length of the field to fit. For example, picking ID String 1 as a data allows up to 20 characters in the small font. If you leave the field length at 20, the only available starting point is 1. However, if you shorten the ID String 1 length to 10, the start column can range from 1 to 11.

```
NET-GROSS-TARE WT
1▶Current Weight 8 C
2▶ Start Column *
3 Gross Weight
4 Start Column
5 Tare Weight
6 Start Column
```

This screen illustrates a typical data selection. In this case, the current weight selection. The start column line has an asterisk indicating that the current weight is already in the display set, but not found on the line you are currently programming. You can turn off the current setting by selecting the number, and then entering the parameters for the current line you are setting up.

```
NET-GROSS-TARE WT
1▶Current Weight 8 C
2▶ Start Column 1
3 Gross Weight
4 Start Column
5 Tare Weight
6 Start Column
```

This screen illustrates that the current weight is on the line you are now setting up, and it starts at column 1. Since only the large font will fit a weight display in 8 characters, the start column will not allow a change.

```
NET-GROSS-TARE WT
1▶Current Weight 14C
2▶ Start Column 1
3 Gross Weight
4 Start Column
5 Tare Weight
6 Start Column
```

This screen illustrates a 14 character current weight on a small or medium font line, and it starts at column 1. If the line you are setting up is a small font line, the start column will range from 1 to 6. In the medium font, the start column will range from 1-3.

CUSTOM SCREEN SETUP PROCEDURE

You should setup both a single channel and multiple channel custom setup (unless you only have 1 channel)

- 1) Press **SETUP**, then **DISPLAY** or **SETUP**, “MORE” [7], then “Scale Display” [2].
- 2) Select “Single Scale Mode” [1], or “Multi Scale Mode” [2].
- 3) Select “Custom” [6].
- 4) Multi-channel setup only: Pick the scan list index to program (1-8). Keep in mind that you must use small fonts if you want to see all eight scales on one screen.
- 5) Select the size font you want to use.
It is best to program from large font to small font so that you can see the impact of data location on other rows.
- 6) Select the row(s) for the data items.
- 7) Select the broad type of data you want to place on the selected row. Select [1] for product ID parameters including total and ID Strings. Select [2] for all weight types. Select [3] for Channel Info such as channel name, scan list index, and channel number. Select [4] for text and miscellaneous data such as grand totals and bar code data. Select [5] for date and time data placement.
While in this menu, the line preview is displayed, use the CLR key to delete the current line setup. Use the [0 Space] key to delete only the data present in the current size font, while leaving other size data intact.
- 8) Select the exact data type. If the field is a variable type, a number entry screen will appear. Program the number of characters needed. The available range appears on the number entry screen.
- 9) Change the start column as necessary. If the line is full, the start location cannot be changed.
- 10) Press the **ESC** key until you are back to the font size selection menu. Repeat steps 6-9 until the screen is exactly how you want it. Use the Preview selections found on several menus to observe your work in progress.
- 11) When finished press the **EXIT (DISPLAY)** key to return to normal operation.

CUSTOM SINGLE CHANNEL DISPLAY SETUP MENU

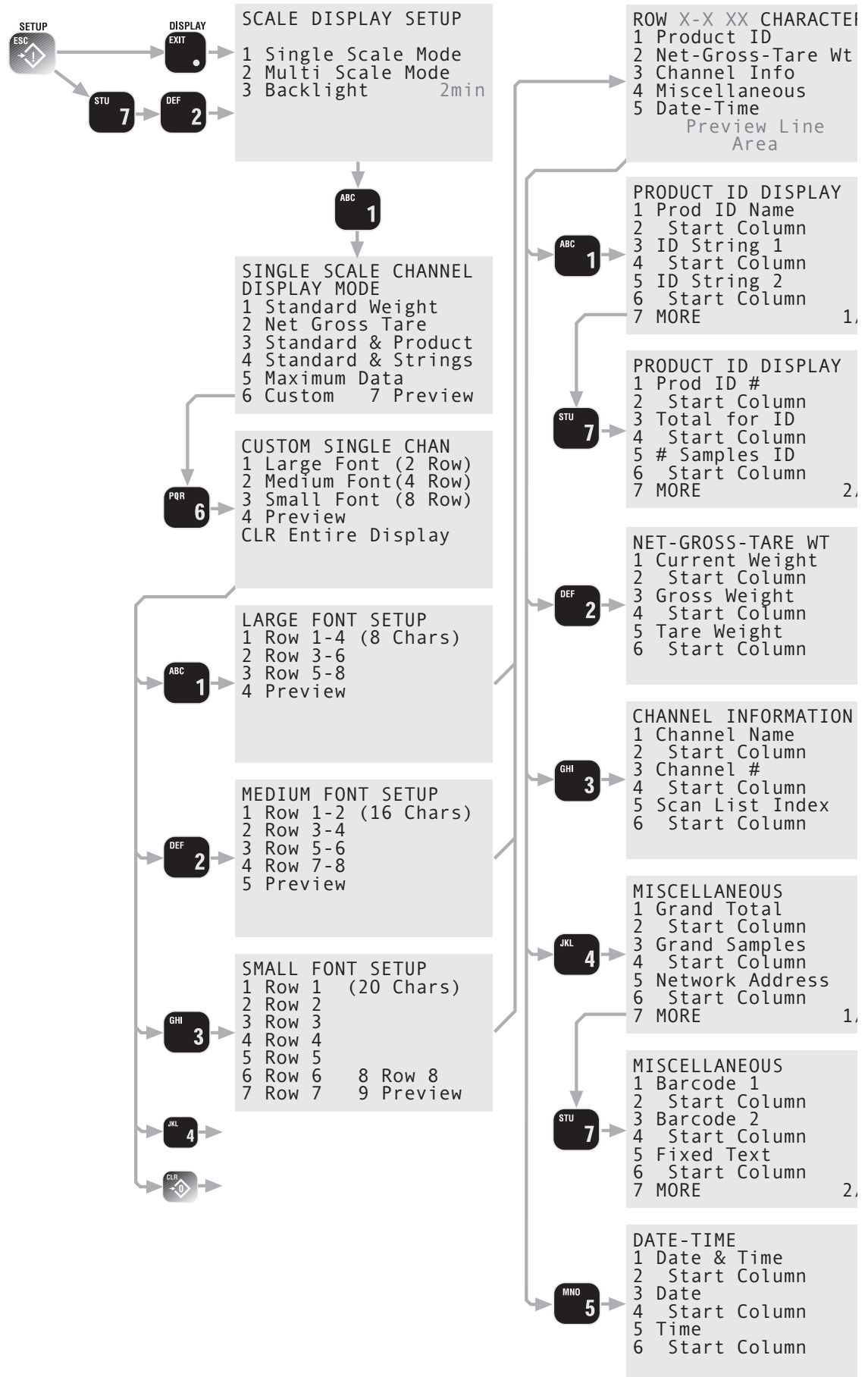



CUSTOM MULTI-CHANNEL DISPLAY SETUP MENU

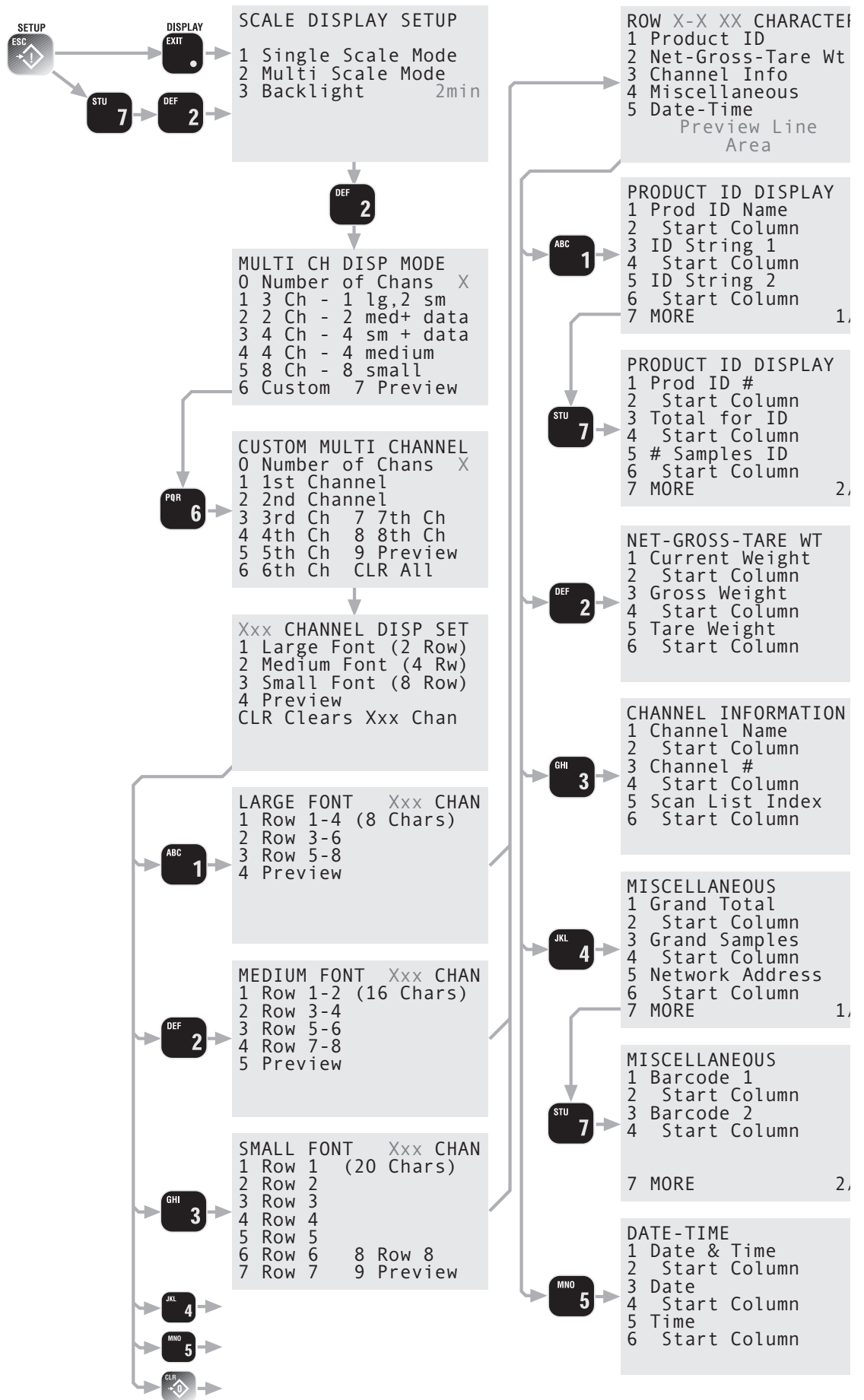

SECTION 8 – SET POINTS

INTRODUCTION

The CellScale system provides extensive Set Point capabilities. Up to 32 Set Points are available. The CellScale performs the A/D conversions and does limit checking for all the Set Points. The 9750A receives Set Point information from the CellScale and responds as programmed.

All 32 Set Points are setup from either the CellScale Terminal Interface, from a 3750CS, or from the 9750A. All Set Point value parameters are stored in the CellScale and are independent of any other device, including the 9750A. When a Set Point is tripped (true condition) and when it resets, the CellScale transmits to all connected 9750's a message signifying which Set Point tripped and/or reset. The 9750A can display messages for both tripped and reset conditions.

The 9750A Meter can fill a variety of applications in control, batching, safety and informational warnings. Set points can be used to trigger RS-232 data transmissions (see "COMM PORTS"). All 32 Set Points can put an independent message on the display for both tripped and reset conditions.

Unique to 9750A Parameters

The 9750A can respond to the Set Point transmission in several ways:

- 1) Audible Alarm – 4 unique tones available for both set and reset conditions.
- 2) Display a message on the alphanumeric display in 3 font sizes. Using the large font size, the whole display provides a set point indication. The medium font size takes over the bottom two lines with up to 16 characters. The small font size takes over the bottom line with up to 20 characters.
- 3) Send a message out the RS-232 port of the 9750A. This message can include weight parameters, time, date, and any random text the user requires (using MSI @ codes).

These actions are independent of what the CellScale does, and are independent of other 9750's or 3750CS's that might be on the Network. These Set Point actions are stored only in the 9750A and must be programmed independently in all 9750's used in the system.

Parameters stored in the CellScale

All parameters related to the Set Point values are stored only in the CellScale, programmed by a 3750CS or a 9750A via RF, or by the Terminal Interface program directly into the CellScale. These parameters include the following:

- 1) One or two threshold values (Value 1 and Value 2).
- 2) An "Operator" for each value (Oper 1 and Oper 2) which specifies whether the Set Point is Less Than, Greater Than, etc..
- 3) An Operator Relationship (Op Relat) which specifies an "AND" or "OR" relationship between Value 1 and Value 2.
- 4) A "Trigger Type" for each value (Trigtyp1 and Trigtyp2) which specifies if the Set Point responds to Gross weight, Net weight, Total weight, or number of samples in the total (nSamples). "nSamples" can also be thought of as a box counter or load counter.
- 5) Preact, Postact, and Deadzone – These parameters modify the value of the Set Point for process control applications. The effect of these value modifiers is detailed below.
- 6) Input Source – This parameter relates the Set Point to a position in the Channel List. This allows any Set Point to be assigned to any input channel or Math channel in the Cell Scale.
The Channel list must be configured in the CellScale. It cannot be programmed from the 9750A.
- 7) Output Destination – The output destination list is also configured in the CellScale and is used to direct Set Point outputs at the CellScale end. See the CellScale manual for further information on this parameter.
The Output Destination list must be configured in the CellScale. It cannot be programmed from the 9750A.
- 8) Latching – Any Set Point can be configured to Latch on when tripped so even when the set point is no longer true the output remains on.
- 9) Delay – Any Set Point can be delayed by up to 10 seconds (10000 ms). Often used to prevent spurious Set Point outputs.
- 10) On/Off – Any Set Point can be turned on or off independently from the rest without losing any programmed parameters.
- 11) All Set Points On/Off – Used to disable the operation of all 32 Set Points.



SET POINT SETUP MENU

There are three ways to program values, operators, and remote relays for Set Points. 1) Use the Terminal Interface Mode at the CellScale, 2) use a 3750CS, or 3) use the 9750A.

To Enter the Set Point Setup Menus

- 1) Press **SETUP**.
- 2) Select “Set Points” by pressing [**2**].
- 3) The “MASTER SET POINTS” menu appears. Menu items 1-5 are discussed next.

- 1) Program Set Point – Enter the set point number from 1 to 32. This determines the set point that subsequent menus will operate on. Go to “PROGRAM SET POINT” menu (next page).
- 2) Set Points Enabled/Disabled – This is the master switch for all set points. When disabled no Set Point will operate. You must Enable the set points here for any set point to operate.
- 3) View Status – The LCD displays all 32 Set Points along with a status indication. The 9750A queries the master CellScale for status. This can take several seconds to fully update (a low priority task for the CellScale). Select the desired Set Point to program with either the cursor keys, or key in the number.

Pressing a number from 1-3 will cause groups to highlight waiting for a second key. If no second key is pressed within 3 seconds, Set Point 1, 2, or 3 is selected. To go immediately to Set Points 1-3, press the ENTER key after pressing 1-3. Press the ALPHA key to see the Set Point names (if any) entered in the 9000.

Once the desired Set Point is highlighted, press the **ENTER** key to set up the set point response. Go to “PROGRAM SET POINT” menu (next page).
- 4) View Status w/Name – Same as above except the Set Point name is displayed along with the Status. Press the **ALPHA** key to enter or edit a set point name. Use the Cursor keys to see the second half of set points (17-32).
- 5) Clear Latches – Any set point that is latched on is cleared with this selection. However, if the tripped condition still exists, the set point will remain on and latched.

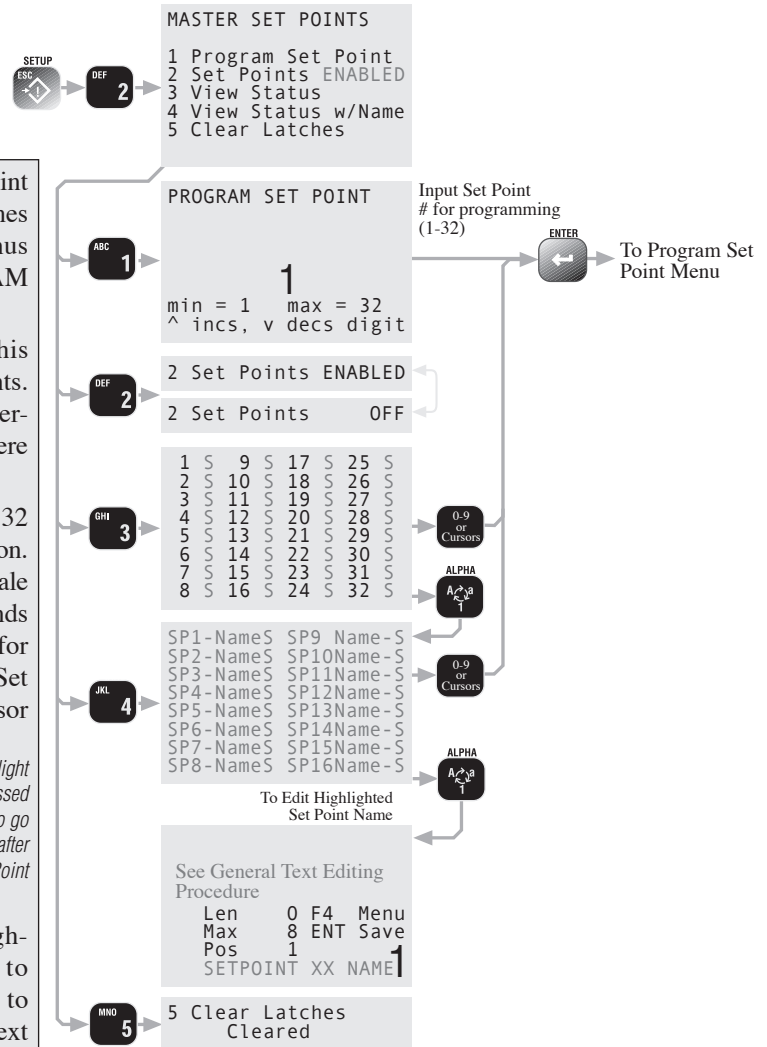

Status Indicators

U	Unknown – the CellScale has not yet reported the Set Point Status
O	Off – All Set Points are off
D	Disabled – This Set Point is off
R	Reset – Set Point not tripped (inactive state).
T	Tripped – Set Point active

PROGRAM SET POINT MENU

```

1 SP XX -SPName- OFF
2 9750 Response OFF
3 Input Source XX
4 Output Assign XX
5 Delay XXXXXms
6 Latch OFF
7 Force Output OFF
8 Formula 9 View
    
```

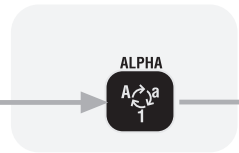

```

Len 0 F4 Menu
Max 8 ENT Save
Pos 1
SETPOINT XX NAME 1
    
```

This Set Point Menu is reached from the procedure on the previous page.

- Individual Set Points are turned on (enabled) or off (disabled) by pressing [1]. Disabled Set Points can still be programmed, but will not operate until enabled.
- 9750A Response – This menu item sets the response modes of the 9750A. The submenus are detailed on the next page.
- Input Source – Input the scan channel index number (1-32) for the scale input or math channel this set point is compared to.
In a single Scale channel CellScale system, the input source would always be "1" as this would be the only channel in the scan list.
- Output Scan List Location – Input the Output List choice for this set point. Output lists are set in the CellScale. The output list controls the CellScale response and has no effect on the 9750A.
- Set Point Delay ms – Set point delays are used to eliminate spurious alarms on transient events or to delay the set point action. Enter the desired delay in milliseconds (1000ms = 1 second). 0 to 10000ms range (10s). Actual resolution is 50ms. The number will be rounded to the nearest 50ms.
- Latch – A set point latch forces the set point output to remain on even after the set point trip condition is removed. Defaults to OFF.
- Force Output – Used to test external response settings of the set point. Forcing the output on will cause all set point responses to operate. Be sure to force the output back off when finished.
Caution: This function will turn on relays, warnings, alarms, etc. Be sure that no damage will result to equipment by forcing the outputs on. This function is automatically cleared when leaving the set point menus.
- Formula – Use to program the set point formula. See "Input Formula Menu".
- View – Shows trigger and reset points for this set point. Used to confirm the formula. N/G indicates the set point responds to Net or gross weight.

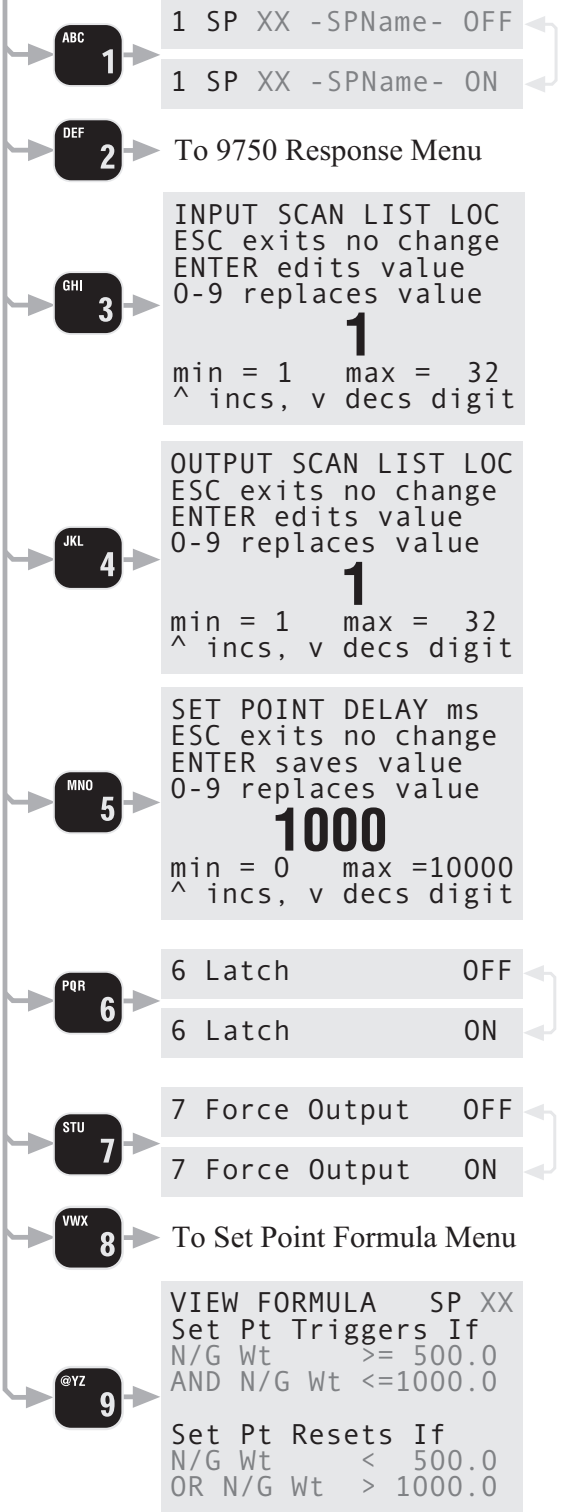



9750A RESPONSE MENU

The 9750A responds to set points in three ways: with an audible alarm, a message display, or a message sent to comm port 1. These menus program this response.

```

SET POINT XX
1 Audible Alarms OFF
2 Alarm Display OFF
3 Alarm to Comm1 OFF
    
```

- 1) Audible Alarms – 5 different tones are available for the tripped condition and/or the reset condition. Audible alarms stay on until either the condition clears, or any 9750A button is pressed. Press F3 or F4 to hear the tone. Adjust the volume of the alarm tone by pressing the **B/G** key (**NET/GROSS**).
- 2) Alarm Display – Display a message on the 9750A LCD. Messages replace all or part of the current weight display and flashes reverse characters until the message is acknowledged. The “Large” display [2] replaces the entire display with up to 16 characters. The “Medium” display [3] replaces the bottom 2 lines with up to 16 characters. The “Small” display [4] replaces the bottom line with up to 20 characters. Alarm messages stay on until either the condition clears, or until acknowledged by the user by pressing any key. See a sample of the display mode by pressing [F3] or [F4]. Edit the message display by pressing [5] for the trip message or [0] for the reset message.
- 3) Alarm to Comm1 – Provides a means to make a printed or stored log of alarm events. The 9750A will output a message to the Comm Port or to data-logging memory (see Comm Port setup, page xxx) when the set point trips and/or resets. All 32 Set Point messages are up to 64 Bytes long each and can include MSI @Codes allowing the recording of weight, date, time, and other data when the set point occurs. Press [3] to edit the trip print string or [6] to edit the reset print string. Pressing [F3] or [F4] will cause the string to output to the comm port or memory (depending on the Comm Port settings).

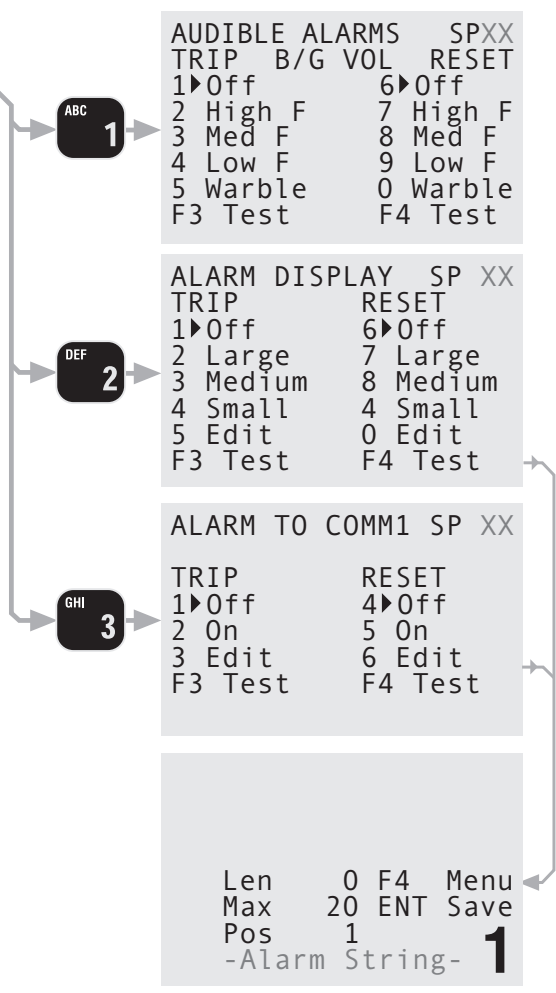

Clearing Audible Alarms and Display Messages

The audible alarm and display message will continue until the condition is cleared or you press any key. If multiple alarms occur, the alarms are prioritized by Set Point number. Set Point 1 has priority over all set points. Set Point 2 has priority over all set points except Set Point 1, and so on.

SET POINT FORMULA MENU

FORMULA	SP	XX
1 Operator 1	>	
2 Value 1	XXXXXXX	
3 Val 1 Type	GROSS	
4 Dual Value	OFF	
5 Preact	XXXXXXX	
6 Deadzone	XXXXXXX	
7 View Formula		

The Set Point Formula Menu controls the compare values and Set Point type selection.

- 1) Operator 1 – Use the sub-menu to select the compare operator. In dual value alarms, this operator only applies to value 1.
- 2) Value 1 – Pressing [2] brings up a number entry screen allowing the set point value entry.
- 3) Val 1 Type – This menu determines the weight type the set point will use in compare. Use Gross [1] for overload alarms that should not change even if the scale is in Net mode. Use “Net or Gross” [2] if the set point should be relative to Net or Gross zero such as when weighing product for sale. Use Total [3] for a set point that uses the current ID total register value. Use “# of Totals” [4] for a set point that responds to the number of total weighments. Useful as a box counter or product counter.
- 4) Dual Value – Enabling dual value allows window set points with upper and lower values. Use the sub-menus to set the operator [1], value [2], weight type [3], and the Relationship [4] for value 2. There are three relationship choices: AND, both set point conditions must be true for the set point to trigger. OR, if either set point condition is true the set point triggers. NONE, Value 2 is ignored, only value 1 is used.
- 5) Preact – Enters a value that subtracts (>) or adds (<) to the basic set point.
- 6) Deadzone – Enters a hysteretic value for the Set point.
- 7) View Formula – Show the whole effect of all the entries. N/G is used for Net/Gross Wt.
See the CellScale 9000 User Guide for a through explanation of Set Point operation and how to control relays

DIRECT RELAY CONTROL

The 9750A provides direct remote relay control for remote control operations, start-stop conditions, etc. This feature uses the Set Point output controls, which must be set up in the CellScale.

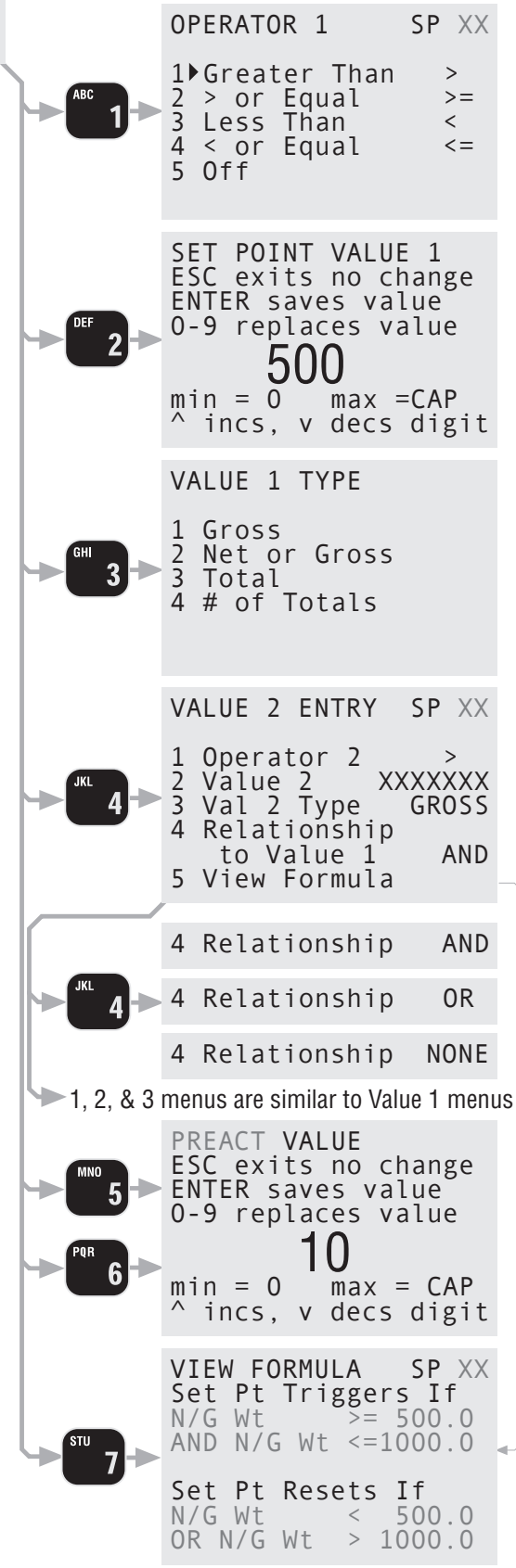



SECTION 9 – COMMUNICATION PORTS

INTRODUCTION

- The MSI 9750A is equipped with a single RS-232 serial input / output. The Comm Port is intended for interfacing printers, data loggers, scoreboards, and computers to the 9750A Meter. The real-time clock allows the user to time and/or date stamp any data obtained from the 9750A. Planned for future release is an interface to Bar Code Scanners.
- The data output is fully format able. The 9750A, under menu control will print control characters for easy interfacing to any label printer. An initialize string combined with start string, product labels, user programmable data, weight data, and end strings, provides complete control over printed data.
- Many scales and weigh meters suspend weighing operation while printing and will not function until a print job is completed. The MSI 9750A RS-232 output uses advanced DMA (direct memory access) techniques for transmitting the print strings. This prevents long print jobs from interfering with scale operation.

Comm Port Function

The RS-232 output is used in conjunction with the SEND/PRINT key to output weight and total data to a printer. In addition there are several automatic print modes including print on Total, when there is a weight change, or when a set point is reached. Interval and continuous printing is available for data logging or interfacing Scoreboard displays. The SEND/PRINT key can also trigger remote data output to other devices on the CellScale network.

ELECTRICAL CONFORMANCE

The electrical characteristics of the serial input / output conform to the EIA Standard EIA-232-D (downward compatible with RS-232C). Comm Port 1 is configured as DTE. Cable connections include RXD (input), TXD (output), Ground, CTS (input), RTS (output), and Shield Ground (also known as Frame Ground). CTS/RTS handshaking is optional and the lines do not need to be connected. Bar Code enabled 9750A have 6-9 Volts DC on pin 9. This voltage will not harm any standard PC ports, but its effect on the RI line

MATING CABLE

The 9750A uses a standard DE-9 Male connector, compatible with commonly available serial cables. To connect the 9750A to standard PC's use a 9 pin female to 9 pin female null modem cable.

DATA CONFIGURATION

The 9750A serial port is configured with the “Comm 1 & Strings” Menus. Standard data configuration is:

Data Strings

A Data String is simply a collection of characters stored in memory, that are used to format the Comm Port output or Data Logging memory. Data Strings are defined by the user. The length of the formatting strings are limited to 512 characters. However, since 3 or 4 character commands can cause an output of up to 99 characters in length, the 512 limit does not represent the maximum size of the data output. The 9750A offers the programmer the ability to print or store any and all weight data, time and date stamp, and formatting controls suitable for even the most complex bar code printer.

Data Format

Each transmitted reading consists of a number of programmable character strings. Data is completely user programmable and can include formatting characters, Time and Date, and text in addition to all weight parameters. The End-of-Line string is used for Carriage Return or other end-of-line control characters. These are easily entered through the Comm Ports menu or downloaded through a computer.

TRIGGER PRINT

The MSI 9750A serial port functions in any of 10 Trigger Print modes:

- 1) Continuously – The Data String can be transmitted continuously at the rate set in the Interval Menu. How fast the weight data updates is determined by the transmission rate in the Master CellScale. “Motion Check” determines if printing is allowed (Motion Check Off) or disallowed (Motion Check On) when the weight is not stable.
- 2) Send / Print Key – This is a print on command mode which works when the Send / Print key on the front panel is pressed. The Send / Print key is active in all modes unless disabled with the Function key setup or the Lock Function. The “Motion Check” menu selection determines if printing is allowed or disallowed when

- the weight is in motion and/or not stable.
- 3) Print on CTS (Clear to Send, a RS-232 handshake line) – By toggling the CTS line from space to mark, the print string will be transmitted. If an interval is set, the string will continue to print as long as CTS is asserted. “Motion Check” determines if printing is allowed (Motion Check Off) or disallowed (Motion Check On) when the weight is not stable.
 - 4) Print On Weight Change – Every time the weight changes 1 full display count or more, one transmission of data will occur. “Motion Check” determines if printing is allowed or disallowed when the weight is in motion and/or not stable. Interval has no effect in this mode.
 - 5) Print on Stable Load – When the load weight exceeds the Total Threshold and motion ceases, one transmission of data will occur. Once transmitted, the scale must return below the Total Threshold to re-enable the transmission. Interval has no effect in this mode.
 - 6) Print On Total – When the weight is totaled, one transmission of data will occur. Once transmitted, the scale must return below the Total Threshold (See Total Setup) to re-enable the transmission. Interval has no effect in this mode.
Using Print on Total with the Auto Total enabled should not be used with any weight print-out other than W5, W6, W7, or W9 (because the actual total doesn't occur until weight drops below the threshold, so the weight used for the Total would no longer be on the scale). Use “Print on Load” to print the weight used for the total.
 - 7,8,9,10) Print on Set-Point – Set point 1, Set point 2, Set Point 1 and 2, or Set-point 1 or 2 can be configured to trigger a data print. Once transmitted, the set-point must go off then on again to transmit again. Print on a set point can also be configured to print when two set-points are true (AND) or when either Set Point 1 or Set Point 2 are true (OR). This configuration allows printing when the weight is outside two limits or when the weight is inside two limits (windowed). “Motion Check” determines if printing is allowed (Motion Check Off) or disallowed (Motion Check On) when the weight is not stable.

In addition to the Control modes above, the master CellScale can also force formatted print strings out the Comm Port. See the CellScale manual for more information on Set Point messages and other types of remotely generated messaging.

There is also a special print mode used with the VIEW key. Pressing VIEW Σ followed immediately by the PRINT key will output just the current ID Codes total and Total Count. See “@W7” for formatting information on this special output.

COMM PORT SETUP MENU

[1] ENTER EDIT STRINGS: is the heart of the communications system. It controls the data output generated by the 9750A Meter.

- 1) Data Out String: This is the main formatted output string. Any weight or other data can be included with the use of the MSI “@” codes. Up to 512 Bytes
- 2) End String: The End string can be 0 to 64 characters long. Most commonly used for Carriage Return (CR) or Line Feed (LF), or CR/LF. The EOL string defaults to Carriage Return / Line Feed. See “Programming the End of Line String for an example.
- 3) Start String: The Start string can be 0 to 64 characters long. It is intended for commonly used commands that usually precede printed lines. Typically ESC codes are used on some printers to enable or format the print string. The start of line string is usually referred to as the “SOL string”. The string defaults to empty.
- 4) Wait Character: The “WAIT CHARACTER”, if entered, will cause the print output to pause after each EOL string until the designated character is received by the port. To use the Wait Character mode, the Comm Port mode must be Duplex. Once the proper Wait Character has been received the 9750A will output the next data string up to the next EOL string.
- 5) Aux String: The Aux String is an additional formatted output string primarily intended for use in the Data Logging feature to provide additional information embedded in the data stream.
- 6) Ack String: The Acknowledge String is sent back to the Host port that sent a message to this 9750A. See “Text Messaging” for more detail. This string defaults to the ASCII ACK command but any message up to 32 bytes can be entered.

[2] OUTPUT INTERVAL: Selecting “Print Once” [CLR] means that after the trigger condition, a single transmission of data will occur. For continuous output, a print interval can be entered from 50ms to 50 days in 50ms increments. Used in conjunction with the Continuous Trigger mode, this can generate a time based data-logging system. An interval of 50 milliseconds means that the scale will output data at the highest rate possible (also limited by the transmission rate from the CellScale). Interval used with other control modes can be useful for control and monitoring purposes.

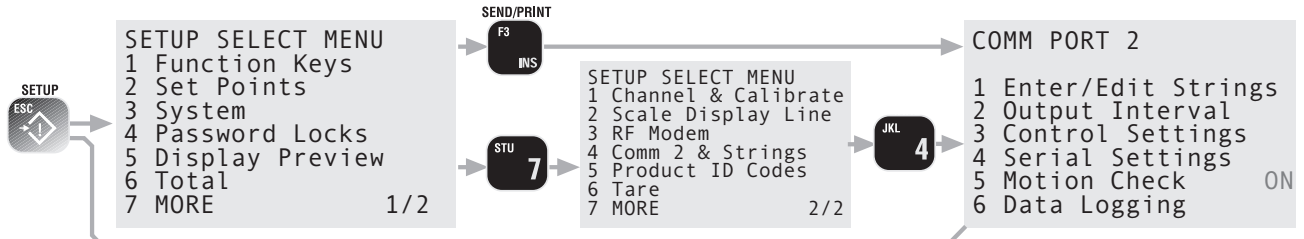

[3] TRIGGER PRINT ON: The “Trigger Print On” menu designates the condition that causes the 9750A to output data. The Send / Print key will always work unless specifically locked out or the function key is reassigned. When the designated trigger condition occurs, the print string specified in the “Data Out String” will be output on Comm 1. If the “Motion Check” parameter is set to “ON”, the weight must be stable before the 9750A will output data. If a valid trigger occurs, the 9750A will wait for the next settled (out of Motion) reading before it will output data. See descriptions of the Trigger Print modes in the “Trigger Print” section above.

[4] SERIAL SETTINGS: The Serial Settings menu is used to set standard Comm Port parameters. See “To Set The Baud Rate” for an example of how to use these setting menus.

STOP BITS: Stop Bits are not changeable and set to 1.

- 1) **BAUD RATE:** Standard Baud Rates available are 300, 600, 1200, 2400, 4800, 9600, 14400, 19200, 28800, 38400, 57600, 76800, 115200, and 230400. The 9750A defaults to 9600 Baud.
- 2) **DATA BITS:** Either 7 or 8 Data Bits can be set. If 7 bit mode is set, Data Characters above 127dec cannot be sent or received. The default is 8 bits.
- 3) **PARITY:** Parity mode is NONE Parity, EVEN or ODD. The 9750A defaults to “NO Parity”.
- 4) **HANDSHAKE:** Comm Port Handshaking is set in this menu. Use “Software XON/XOFF” [5] for software handshaking commonly used in communicating with computers. Use “Hardware DCE” [2] for interfacing with devices with an RTS output and CTS input. Use “Hardware DTE” [3] if the 9750A must produce RTS as an output and CTS as an input. “Hardware RTR/CTS” [4] protocol provides a symmetrical interface. When a device is ready to receive data, i.e., there is no unread data in the serial port receive register, the device asserts the RTR signal. A device does not begin transmitting data until the CTS signal is asserted. Use NONE [1] (default) for situations where no handshaking is required or possible. It is recommended that hardware handshaking is used for all high baud rate applications (>19200 Baud).

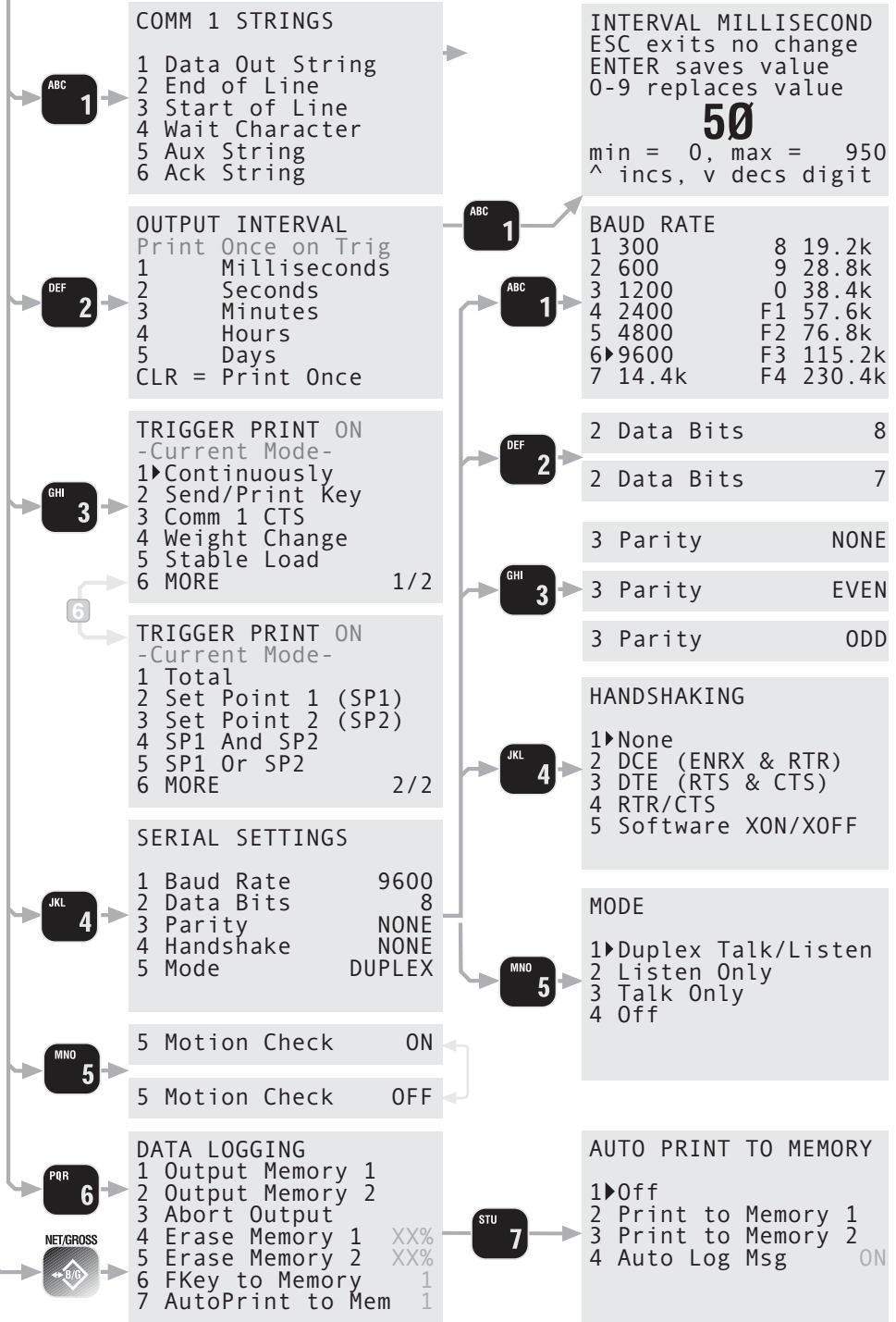

- 5) **MODE:** The MODE menu sets the communications mode for the port. Use “TALK” for outputting data to a printer that uses hardware handshaking or no handshaking. Use “DUPLEX” for printers with software handshaking (XON / XOFF, etc.) or to talk and listen to a computer. Use “LISTEN” to only receive commands from a computer. Use “OFF” to disable the port (and save power on battery units).
- [5] **MOTION CHECK:** When ON the scale will only print settled data, i.e. when the motion detection annunciator is off. Use “OFF” when it is necessary to send data out the Comm port while the weight is in motion. Driving a remote display is a good example of an application usually requiring the Motion Check off.
- [6] **DATA LOGGING:** Controls Data Logging mode and provides access to the Data Logging memory for uploading to host computers and clearing memory. See Section 10 – Data Logging for details on the use of this menu.

GENERAL TEXT ENTRY

The 9750A keypad supports full alphanumeric data entry. Numbers, letters, and ASCII control characters are easily handled through the use of the “General Text Entry Menu”. While in any string entry screen, pressing F4 will bring up the text entry menu providing access to special characters and font control. In addition, the full screen mode can be enabled which removes the information in favor of showing more characters. Even in full screen mode, F4 is still active.

For characters not in the standard ASCII table, the decimal entry mode is provided. This mode allows access to characters above 127 (decimal). Characters from 128d to 255d are used for special characters and graphics by many printers. Note that outputting characters above 127d requires that the serial setting for data bits is set to 8 (see serial settings menu).

Text strings are edited using the cursor keys and the INS key (alternate function of the F3 key). The INS key toggles between the insert mode (narrow cursor between characters) and the character edit mode (character is highlighted). When a character is highlighted, use the keypad to change the character. Also while the character is highlighted, a larger representative character is shown in the lower left corner of the screen. This allows the display of special characters which are held by placekeepers in the smaller fonts.

General Alpha-numeric Entry Procedure

- 1) Use the Aa1 (ALPHA) key to switch between numeric “1”, upper case “A”, or lower case “a”. The current mode is shown in the lower right corner of the display
- 2) Press the desired character key. If a “B” is needed, press the ABC key twice.
- 3) If you need two letters off the same key, pause briefly until the cursor moves to the next position.
- 4) Save the string by pressing **ENTER**.

Text Entry Screen

The following illustration is representative of 9750A text entry screens. The string name is shown on the bottom line of the display. Pressing F4 brings up additional menu items for adding punctuation, symbols, and control characters. An ASCII entry mode is also provided for special characters above 127d.

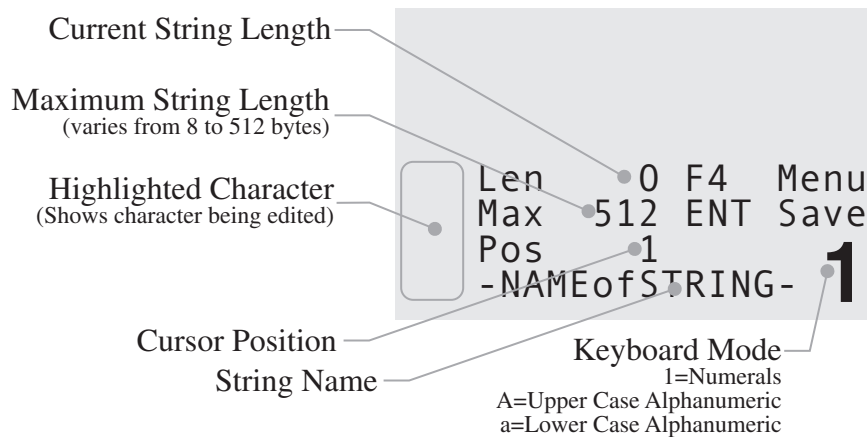



GENERAL TEXT ENTRY MENU

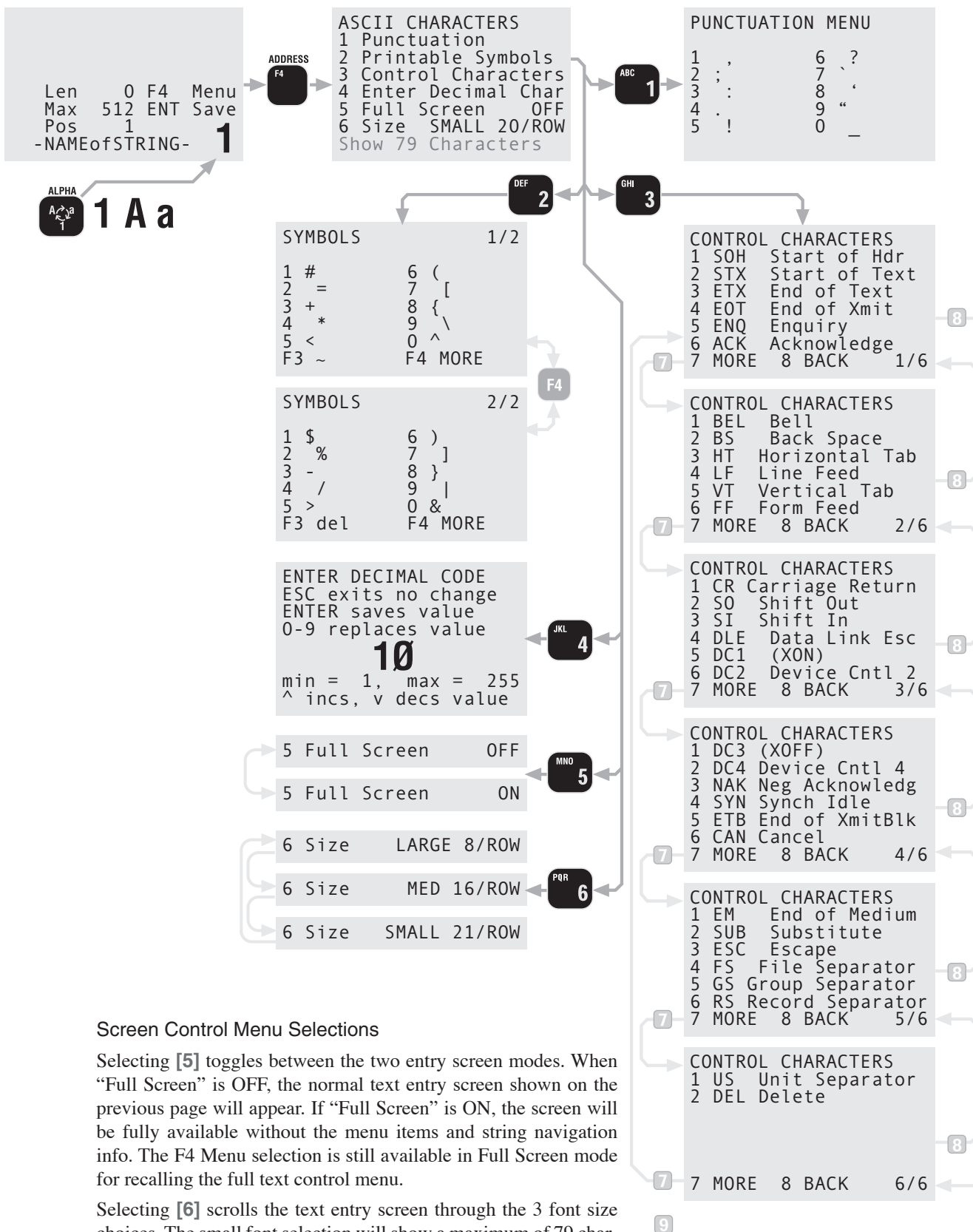

Screen Control Menu Selections

Selecting [5] toggles between the two entry screen modes. When “Full Screen” is OFF, the normal text entry screen shown on the previous page will appear. If “Full Screen” is ON, the screen will be fully available without the menu items and string navigation info. The F4 Menu selection is still available in Full Screen mode for recalling the full text control menu.

Selecting [6] scrolls the text entry screen through the 3 font size choices. The small font selection will show a maximum of 79 characters at a time in standard screen mode, and 156 characters in full screen mode. The medium font will show 31 standard screen and 60 in full screen. The large font will show 7 characters in standard screen and 14 in full screen.

Alternate Characters, Punctuation, Symbols, and Control Characters



- 1) While in the text entry screen, press the [F4] key. This enables the ASCII Characters Menu. This menu provides links to special characters.
- 2) For standard punctuation, press [1]. For other printable characters, press [2]. For ASCII control characters, press [3]. If a special character is needed, use the “Enter Decimal Char” [4] menu to put in the decimal equivalent value of the desired character. This is the only way to enter characters above 127d. These characters, if undefined in the 9750A character set, will be represented by a place keeper.

Alternate Key Characters During Text Entry

-OR-

Use this chart for alternate character entry using the DP, Tare, and Net/Gross keys.

It is usually more efficient to use the @E command, then to put in individual CR/LF characters as this is what the @E string is usually set to.

	Numeric “1”	Upper Case “A”				Lower Case “a”			
		1	2	3	4	1	2	3	4
 . (dp)	.	,	;	:	.	?	!	%	
 - (minus)	-	ESC	STX	ETX	-	SOH	BEL	DEL	
 <space>		HT	CR	LF	FF	SO	SI	DC2	DC4

PRINTER / OUTPUT FORMATTING

The 9750A can format virtually any Printer or Serial Data Device including complex bar-code label printers through the use of the built in string formatting. To use this versatile feature, the user must input command codes and data in a specific manner. Each command code consists of a 2 letter mnemonic. Some command codes also require a numeric suffix.

A simple example of this structure is the default print data string: @W1@E. The “@W” command code means to print weight. The “1” means print the current display mode. The “@E” will cause the End-of-line string to be printed.

By combining the “@” commands with standard ASCII characters, control characters, etc., any data available from the scale, plus any additional text, can be printed in any order desired. Using formatting controls typical to modern bar-code printers is simply a matter of formatting the printer strings.

The MSI 9750A character set includes all upper case letters, lower case letters, numbers, and most of the rest of the standard ASCII set.

EXAMPLE PRINTER FORMATTING

The following diagram shows a typical print string format. The end result of this example produces a printout similar to this:

PEARS
4.500 lb NET 8/15/2002

In this example we’ll use control characters to both print in red and expand the characters for “PEARS”. Note: control codes used in this example are unique to a specific printer (a Star Micronics DP8340) and are used for example only. Non printing control characters (e.g. ESC, CR, LF, DC4, etc.) are represented by a dot pattern in the smaller font sizes. The necessary string will be:

ASCII	27	14				20	27															
String	ESC	4	S0	P	E	A	R	S	DC4	ESC	5	@	E	@	W	3	@	D	6	@	E	
Notes	①	②							③	④				⑤								⑧

- 1) The 27 is an ESC followed by a 4 which equals “Red Character Print instruction”
- 2) The 14 is an SO which turns on the Expanded character instruction
- 3) The 20 is an DC4 which turns off the Expanded character instruction
- 4) The 27 is an ESC followed by a 5 which turns off the Red Character Print instruction
- 5) @E causes the end-of-line string to be sent. In this example, the end-of-line string is programmed as CR/LF.



- 6) @W3 causes the current Net weight to be printed. If the scale was in the NET mode, @W1 would have worked as well.
- 7) @D6 causes the current date to be printed in MM/DD/YYYY format
- 8) @E causes the end-of-line string to be sent (CR/LF).

PROGRAMMING THE END OF LINE OR START OF LINE STRINGS

The End of Line String is used to terminate print strings and is printer dependent. The default string is Carriage Return (CR=ASCII 13d), Line Feed (LF=ASCII 10). The Start of Line String is often used for STX commands or other configuration control characters. The default SOL string is empty. Refer to the ASCII table in the Appendix for proper codes. Up to 64 characters can be included. You can also embed @ codes to expand the two strings. However, be careful not to include @E in the End of Line string, or @F in the Start of Line string.

EDITING THE PRINT STRING

Editing the print string is controlled by the **INS** key (alternate function of **F3**). The **INS** key alternates the cursor between the Insert mode (narrow cursor between characters) and the Replace mode (character highlights).

To insert a character (narrow cursor)

Use the LEFT(◀), RIGHT(▶), UP(▲), and DOWN(▼) Scroll keys to move the cursor around in the print string. Insert new characters behind the cursor. Press **ENTER** to store the edited string.

To change a character (highlighted character)

Use the LEFT(◀), RIGHT(▶), UP(▲), and DOWN(▼) Scroll keys to move around in the print string. Change the cursor into a highlighted character by pressing the **INS** key. The flashing digit indicates the edit able character which is also shown in the lower left hand corner of the edit screen. Once the desired character is flashing, use the keypad and the ALPHA key to input any character. If you need to change it to a character not in the 9750A keypad, press **F4** to bring up the alternate character entry screen. Press **ENTER** to store the edited string.

To delete a character

Use the LEFT(◀), RIGHT(▶), UP(▲), and DOWN(▼) Scroll keys to move around in the print string. Change the cursor into a highlighted character by pressing the **INS** key. The flashing digit indicates the edit able character which is also shown in the lower left hand corner of the edit screen. Press **CLR**. The remaining characters move over 1 space. Press **ENTER** to store the edited string.
Pressing the ESC key will exit out of the menu and restore the string as it was. The changes must be saved with the ENTER key.

To Erase the Entire Print String

When first entering into the edit text screen, the entire string is highlighted. Press the **CLR** key rapidly 3 times and the entire string will be erased.
Press the ESC key to restore the string as it was.
 Press **ENTER** to store the empty string.

GENERAL TEXT / CONTROL CHARACTER ENTRY

Text or control characters are simply entered into the printer data string. All ASCII characters from 1dec to 127dec can be entered with the exception of the "@" symbol which the 9750A uses for its control characters (enter "@@" to print a single "@"). If 8 bit data transmission is enabled additional codes 128 to 255 can also be assigned. These upper numbers are often used for graphics characters on printers. "@" Commands are case sensitive, only capital letters are used.

Input Data Form

With the exception of characters following the command "@" symbol, all characters are treated as printable text or control characters. The MSI 9750A represents characters that can't be displayed on the LCD with a checkered pattern. The "ASCII Characters" Menu is provided to input Punctuation, Symbols, Control Characters, or the decimal byte value for any other character not included in the standard 9750A character set. Use the ASCII table (Appendix B) to determine the decimal number equal to any desired character. Some serial devices will define special functions or characters for values above 127, the standard end of the ASCII character set.

SERIAL OUTPUT “@” COMMANDS

The printer formatting “@” commands and their data configurations are as follows:

@+ Change to next SC Index (Channel List entry)

Use the @+ command to change to the next entry in the SC Index. All subsequent commands which are channel related will be directed to the new active Channel. This command is only applicable to multiple channel systems.

@- Change to previous SC Index (Channel List entry)

Use the @- command to change to the previous entry in the SC Index. All subsequent commands which are channel related will be directed to the new active Channel. This command is only applicable to multiple channel systems.

@@ PRINT AN “@”

Use the @@ command to cause the output to send an “@” sign. Since this character is normally used for printer formatting, this is the only way to output the @ sign by itself.

@B PRINT BLANK SPACES

Use the @B command to cause the output to send a series of spaces. Can be used to position data on a label without having to enter multiple spaces.

Input Data Form:

@Bxx where xx is any number from 01 to 99 which equals the number of spaces desired. Note: Exactly two digits must follow the “@B” command.

Output Data Form:

“x” spaces are output limited to 99. For more spaces use two @B commands in series.

Note: For spaces fewer than 5, it is more memory efficient to enter spaces instead of the @B command.

Example - Centers “MSI-9750A” on a 20 column printer:

@B06MSI-9750A@E

The @B06 command printed 6 spaces followed by “MSI-9750A” and then the End of Line string.

@C PRINT ID CODE NUMBER

Use the @C command to cause the output to send the current product code number. The number can vary from 0 to 999 depending on the current ID# that the scale is set in. Note that the default ID# is always 1, so the lowest alpha entry will be ID#2.

Input Data Form:

@C1 to print the ID Code number plus descriptor

@C2 to print the ID Code number only

Output Data Form:

@C1 ID CODE # 4

Length: 12 Justification: “ID CODE” left justified, number right justified.

@C2 4

Length: 3 Justification: right

@D PRINT DATE

Purpose:

Use the @D command to print the date register of the real time clock/calendar.

Input Data Form:

@D1 Full alpha date in the form DDMMYY with the month spelled out

@D2 Print date in the form MM/DD/YY



@D3	Print date in the form DD/MM/YY (European Standard)
@D4	Print the day of the week
@D5	Full alpha date in the form DDMMMYYYY with month spelled out
@D6	Print date in the form MM/DD/YYYY
@D7	Print date in the form DD/MM/YYYY (European Standard)
@D8	Print date in the form YYYYMMDD (ISO Standard)

Output Data Form:

@D1	25JUL03
Length: 8	Justification: left, leading day zero suppressed
@D2	4/25/03
Length: 8	Justification: full, leading month zero suppressed
@D3	25/07/03
Length: 8	Justification: left, leading day zero suppressed
@D4	SATURDAY
Length: 10	Justification: left, position 10 always a space.
@D5	25JUL2003
Length: 8	Justification: left, leading day zero suppressed
@D6	4/25/2003
Length: 8	Justification: full, leading month zero suppressed
@D7	25/07/2003
Length: 8	Justification: full, leading month zero suppressed
@D8	20030725
Length: 8	Justification: full, leading month zero suppressed

@E PRINT END OF LINE

Use the @E command to output the end-of-line string. The EOL string is entered in the printer Format section

Input Data Form:

@E

Output Data Form:

Sends out the EOL string, up to 64 bytes. Usually a Carriage Return or Line Feed, CR/LF, ETX, etc. Can include formatting commands. See Format.

@F PRINT START OF LINE STRING

Use the @F command to output the Start of Line string. The SOL string is preprogrammed in the "COMM PORT Setup Menu".

Input Data Form:

@F Print SOL String

Output Data Form:

Sends out the SOL string, up to 64 bytes.

@H PRINT HORIZONTAL TABS

Purpose:

Use the @H command to send a series of Tabs. Can be used to position data on a label without having to enter multiple spaces. Not all printers support tabs. Check with printer manual for proper application of tabs in printer formatting.

Input Data Form:

@Hxx where xx is any number from 01 to 99 which equals the number of tabs desired. Note: you must enter two digits following the "@H".

Output Data Form:

“x” tabs are printed (limited to 99). For more tabs use two @H commands in series.

@I OUTPUT RF MODEM ID

Use the @I command to print the RF Modem ID numbers of the connected CellScale and the internal 9750A modem.

Input Data Form:

@I1 Print current Network number (0-31)
 @I2 Print Address ID (0-254) of the master CellScale

Output Data Form:

@I1 **XX**
 Length: 9 Justification: right, leading zeros not suppressed
 @I2 **XXX**
 Length: 9 Justification: right, leading zeros not suppressed

@K OUTPUT BAR CODE DATA

Use the @K command to output data obtained from the bar code scanner

Input Data Form:

@K1 Bar Code Data 1 (variable length)
 @K2 Bar Code Data 2 (variable length)
 @K3 Bar Code Data 1 (fixed 64 byte length)
 @K4 Bar Code Data 2 (fixed 64 byte length)

Output Data Form:

@K1 or K2 **bar code data.....**
 Length: variable Justification: left
 @K3 or K4 **xxx**
 Length: 64 Justification: left

@L PRINT ID CODE STRINGS

Use the @L command to print one or both of the ID Code Strings. ID Code Strings will change as the ID code number is changed. ID Code Strings can include text, numbers, and control codes thereby allowing the printer format or text to change with the ID Code.

Input Data Form:

@L1 Print ID Code String 1
 @L2 Print ID Code String 2

Output Data Form:

Depends on user entered Strings. Up to 20 bytes unless “@” codes are embedded, which could increase the length of data generated by this command.

Caution: Do not embed an “@L” command inside the ID String as this will cause an endless loop.

@M PRINT WEIGHING MODE

Use the @M command to print either the current weighing mode or print the internal mode strings.

Input Data Form:

@M1 Print Current Display Mode
 @M2 Print “GROSS”
 @M3 Print “NET”
 @M4 Print “TARE”
 @M5 Print “TOTAL”
 @M6 Print “T CNT” (Total CouNT= number of weighments totaled)
 @M7 Print “TOTAL T CNT”
 @M8 Not functional in 9750A, do not use
 @M9 Print “GROSS+” or “NET+” or “AD2TOT” depending on the last totaled weight mode.



Output Data Form:

@M1 *****
 Length: 8 or 9 with DP. Justification: left
@M2 **GROSS**
 Length: 6 Justification: left
@M3 **NET**
 Length: 6 Justification: left
@M4 **TARE**
 Length: 6 Justification: left
@M5 **TOTAL**
 Length: 6 Justification: left
@M6 **T-CNT**
 Length: 6 Justification: left
@M7 **TOTAL, T-CNT**
 Length: 12 Justification: left
@M9 If Gross weight is added **GROSS+**
 Length: 6 Justification: left
@M9 If Net weight is added **NET+**
 Length: 6 Justification: left
@M9 If Register is Empty **AD2TOT**
 Length: 6 Justification: left, the "+" indicates that it is the weight from the last totaled register

@N PRINT NAME

Use the @N command to print the current ID Code Name.

Input Data Form:

@N1 Channel Name
@N2 ID Code Name
@N3 Set Point Name
@N4 ID String 1 Function Key Name
@N5 ID String 2 Function Key Name

Output Data Form:

@N1 **CHNAME****
 Length: 8 Justification: left (*Up to 8 Characters)
@N2 **IDNAME****
 Length: 8 Justification: left (*Up to 8 Characters)
@N3 **SPNAME****
 Length: 8 Justification: left (*Up to 8 Characters)
@N4 **FKEY1*****
 Length: 8 Justification: left (*Up to 8 Characters)
@N5 **FKEY2*****
 Length: 8 Justification: left (*Up to 8 Characters)

@R ID CODE NUMBER

Use the @R command to output the current ID Code Number.

Input Data Form:

@R1 ID Code number with descriptor
@R2 ID Code number only

Output Data Form:

@R1 **ID CODE #xxx**
 Length: 12 Justification: left

@R2 **xxx**
 Length: 4 Justification: left

@T PRINT TIME

Use the @T command to print the current time register from the real-time Clock.

Input Data Form:

@T1 12 hour format with HH:MM
@T2 12 hour format with HH:MM:SS
@T3 24 hour format with HH:MM
@T4 24 hour format with HH:MM:SS

Output Data Form:

@T1 **2:08 PM**
 Length: 8 Justification: full, leading hours zero suppressed
@T2 **2:08:36 PM**
 Length: 11 Justification: full, leading hours zero suppressed
@T3 **14:08**
 Length: 5 Justification: left, leading hours zero suppressed
@T4 **14:08:36**
 Length: 8 Justification: left, leading hours zero suppressed

@U PRINT CURRENT UNITS

Use the @U command to output the current weight units.

Input Data Form: @U

Output Data Form:

@U **LB** **KG** **OZ** **G**
 Length: 4 Justification: left (*Units available depend on capacity and legal-for-trade setups*)

@V PRINT WEIGHT (No Mode or Units)

Use the @V command to print the current weight without units or mode printed.

@V is not available on LFT configured 9750s

Input Data Form:

@V1 Displayed weight (GROSS, NET, DEV, %DEV)
@V2 Gross weight
@V3 Net weight Note: will print dashes if NET mode is not enabled
@V4 Tare weight Note: will print zeros if no TARE value has been established
@V5 Total weight
@V6 n Totals (weighments counter)
@V7 Total + n Totals (Combined @V5 and @V6)
@V8 *Not functional on a 9750A, do not use*
@V9 Last Totalled Weight Note: will print dashes if no weight has been totaled.

Output Data Form:

@V1 @V2 @V3 @V4 @V9
20.502
 Length: 8 Justification: full, leading hours zero suppressed
@V5 **1234567.89**
 Length: 10 Justification: right, leading zeros suppressed
@V6 **1234**
 Length: 5 Justification: right, leading zeros suppressed
@V7 **1234567.89, 1234**
 Length: 16 Justification: each number field - right, leading zeros suppressed



@W PRINT WEIGHT FULLY

Use the @W command to print the current weight with units and mode printed.

Input Data Form:

@W1	Displayed weight with units and mode	
@W2	Gross weight	
@W3	Net weight	Note: will print dashes if NET mode is not enabled
@W4	Tare weight	Note: will print zeros if no Tare value has been established
@W5	Total weight	
@W6	n Totals (weighments counter)	
@W7	Total with n Totals (combined @W5 and @W6)	
@W8	<i>Not functional on a 9750A, do not use</i>	
@W9	Last totaled weight	<i>Will print dashes if no weight has been totaled.</i>

Output Data Form:

@W1	20.015 LB *****
Length: 20.	Justification: Weight - right, Units - left, Mode - left, ***** = Current Mode (GROSS, NET, PK GRSS, PK NET, etc.)
@W2	20.015 LB GROSS
Length: 20.	Justification: Weight - right, Units - left, Mode - left
@W3	20.015 LB NET
Length: 20.	Justification: Weight - right, Units - left, Mode - left
@W4	20.015 LB TARE
Length: 20	Justification: Weight - right, Units - left, Mode - left
@W5	1220.015 LBTOTA L
Length: 22	Justification: Weight - right, Units - left, Mode - left, characters 11,16 and 22 always a space
@W6	1234 T-CNT
Length: 12	Justification: Counts - right, Mode - left, characters 1, 6 and 12 always a space
@W7	432534.85 KG TOTAL 1234 T-CNT
Length: 34	Justification: Weight - right, Units - left, Mode - left, Weighments right, "T-CNT" left
@W9	20.015 KG GROSS+
	If net weight is added
@W9	20.015 KG NET+
	If total register is empty
@W9	_____ KG AD2TOT
Length: 20	Justification: Weight - right, Units - left, Mode - left, the "+" indicates that it is the weight from the last totaled register

@X PRINT STATISTICS VALUE ONLY

Use the @X command to print the statistics of the current ID Code. Numeric value only, no description text.

Input Data Form:

@X1	Average weight
@X2	Minimum weight
@X3	Maximum weight
@X4	Standard Deviation
@X5	Coefficient of Variance (%)
@X6	Grand Total
@X7	Grand Total Average
@X8	Grand Total Number of Samples

Output Data Form:

@X1 @X2 @X3 @X4 @X5 @X7	
	-20.502
Length: 8	Justification: right justified

@X6 1234567.05
 Length: 10 Justification: right, leading zeros suppressed

@X8 12345678
 Length: 10 Justification: right, leading zeros suppressed

@Y PRINT STATISTICS FULLY

Use the @Y command to print the statistics of the current ID Code with text descriptor.

Input Data Form:

@Y1	Average weight	@Y2	Minimum weight
@Y3	Maximum weight	@Y4	Standard Deviation
@Y5	Coefficient of Variance (%)	@Y6	Grand Total
@Y7	Grand Average	@Y8	Grand Number of Samples

Output Data Form:

@Y1 13.355 KG AVG
 Length: 20 Justification: Weight - right, Units - left, Mode - left

@Y2 3.210 KG MIN
 Length: 20 Justification: Weight - right, Units - left, Mode - left

@Y3 20.015 KG MAX
 Length: 20 Justification: Weight - right, Units - left, Mode - left

@Y4 20.015 KG STD DEV
 Length: 20 Justification: Weight - right, Units - left, Mode - left

@Y5 32.50% CO.VAR
 Length: 20 Justification: Weight - right, Units - left, Mode - left

@Y6 43135.55 KG G-TOTL
 Length: 22 Justification: Weight - right, Units - left, Mode - left

@Y7 4.327 KG G-AVG
 Length: 20 Justification: Weight - right, Units - left, Mode - left

@Y8 123456 G-CNT
 Length: 14 Justification: Counts - right, Mode - left

@# DATA FROM SCALE CHANNEL #

Use the @# (where # = 0-31) commands in conjunction with the @Vx or @Wx commands to cause the print string to take data from any scale channel listed in the Channel List. See the CellScale manual for information on setting up a channel list. When preceded by the @0-31 command, do not use the @ sign in front of the weight command; e.g. @1W3. If the @W or @V commands are used without the @0-31 in front, the scale mode currently displayed will provide the data.

Once an @# command is sent, all subsequent scale related commands will function on the set channel, until it is changed again with @#.

Input Data Form (examples, any W or V command will work):

@1W1 Print the Weight in the last display mode of the scale channel in position 1 of the scan list.

@2V0 Print the Gross Weight of the scale channel second in the scan list.

@31W2 Print the Net Weight of the scale channel last in the scan list.

Output Data Form:

Is dictated by the suffix command, see "@W" and "@V".

@#? QUERY SCAN LIST INFO

Use the @?# (where # = 0-31) command to print channel information from any scan list position.

Input Data Form (examples, any W or V command will work):

@1? Print the scan position, channel number, and channel name.

@2? Same except skips blank scan list entries.



@? PRINT CURRENT SC INDEX

Use the @? command to cause the output to send the SC Index number of the active analog channel.

Input Data Form:

@?1 Print current scan index position number

@?2 Print current scan index number (blank positions removed).
If there are no blank positions in the scan list, then @?1 and @?2 will return the same number.

Output Data Form:

@?1 **XX** where xx is the position index number from 1-32.
 Length: 3 Justification: left justified

@?2 **XX** where xx is the position index number from 1-32.
 Length: 3 Justification: left justified

SECTION 10 – DATA LOGGING

INTRODUCTION

The 9750A has two battery backed memory locations for storing scale data. Predefined function keys are available for storing user configured data directly to either memory location. Data Logging uses the “Data Out String” and “Aux String” to store user defined data at the press of a button. Usually the “Data Out String” is programmed with the weight configured as desired. The “Aux String” will often be used to store operator data, production run information, or other data to start or end a data run.

The Data Logger memory is uploaded directly to a computer, serial printer, or other serial device through the use of the Data Logging control menu. This menu allows you to upload either memory location and erase (clear) the memory.

DATA LOGGING SETUP

- 1) Determine the data content required for the main data storage. Using the “Data Out String”, set up the MSI @Codes to generate the required data. Most data base programs require comma or tab delimited data. Be sure to delimit the data as required to allow the receiving program to properly parse the incoming data. Typical data types used are @W to generate weight data with text or @V to produce the weight numeric value only. If more than 1 channel of data is required use the @# command preceding the weight value type. See Section 9 for details on string design.
- 2) To facilitate the data dump, use the Comm Port Serial settings to match the comm port settings of the receiving PC for baud rate (up to 230.4kbaud), data bits (7 or 8), parity (none, odd, even), Handshaking (various hardware or software types), and Mode (usually set to Duplex).
- 3) Program the “Aux String” if needed. Typical data types used here are @T and @D for time and date, @L to recall user entered ID Strings, or fixed text to indicate the start or stop of a run.
- 4) Assign the function keys required for the operation (see Section 4). A good choice for the Data Logging function key is F3 since it is unlikely the Send/Print function is being used in a data logger application.
- 5) If user entered data is required, program a function key for the “Enter ID String 1” (or 2). Then embed the @L1 (or @L2) command in the “Data Out” or “Aux” string as desired.
- 6) For single button access to the Data Logging control menu, program a function key for “Data Logging Control”. However there is a shortcut to this menu that can be used that does not require using a function key: Press **SETUP** followed by **NET/GROSS** for direct access to the Data Logging menu.
- 7) Have the appropriate cable ready for data transfers. A 9 pin female to 9 pin female null modem cable should be used for direct connection to most PC's (MSI P/N 12703, but also available from most computer retailers).

DATA LOGGING CONTROL MENU

The Data Logging Control Menu provides a means to upload stored data, and erase the data logging memory locations.

The Data Logging Control Menu is reached by pressing **SETUP** followed by **NET/GROSS**. Alternatively the menu can be reached through the Comm Port and Strings Menu.

DATA LOGGING

```
1 Output Memory 1
2 Output Memory 2
3 Abort Output
4 Erase Memory 1 XX%
5 Erase Memory 2 XX%
6 FKey to Memory 1
7 AutoPrint to Mem 1
```

STU
7

AUTO PRINT TO MEMORY

```
1 Off
2 Print to Memory 1
3 Print to Memory 2
4 Auto Log Msg ON
```

Menu Description

- 1) Output Memory 1 – Pressing [1] will output all data in Data Logging Memory 1 to the Comm Port. Connect the 9750A to an appropriate terminal or computer before using this function.
- 2) Output Memory 2 – Pressing [2] will output all data in Data Logging Memory 2 to the Comm Port. Connect the 9750A to an appropriate terminal or computer before using this function.
- 3) Abort Output – Press [3] to abort the output function. The data output will cease, and the data will be left intact, with the start of data pointer reset to the beginning of the memory file.
- 4) Erase Memory 1 – Press [4] to erase all data in Memory 1. A caution screen appears requiring confirmation before erasing the data. Once erased, the data is gone, so make sure that it has been transferred using the Output commands before erasing the data. The line indicates the per cent used capacity of memory 1. It will read “CLR” when empty.
- 5) Erase Memory 2 – Press [5] to erase all data in Memory 2. A caution screen appears requiring confirmation before erasing the data. The line indicates the per cent used capacity of memory 2. It will read “CLR” when empty.



Erasing the data logging memory is permanent. The data will be lost. Make sure the data is no longer needed before using the erase memory functions. Erasing data logging memory does not effect any other CellScale memory functions.

- 6) FKey to Memory X – Use the [6] key to choose which memory the data is stored in when using the uncommitted “Save to Memory” function key. Toggles between Memory 1 and Memory 2.
- 7) AutoPrint to Memory – Use the [7] key to bring up the Auto Print to Memory sub menu. This feature allows Automatic data logging using the Trigger Print modes (See Section 9). By using, for example, “Print On Load”, every time a steady weight is reached, the weight will be automatically recorded. Using the Continuous print mode combined with a user set interval, weight data can be recorded on any time interval. AutoPrint to Memory uses the main print string only. The Aux String is still available for manual data storage.

Auto Print to Memory

The “Auto Print to Memory” sub menu has four choices:

- 1) Off – Automatic and Manual Print data is directed to the Comm Port.
- 2) Print to Mem 1 – Automatic print data is redirected to data logging memory 1. Only pressing the Print key will generate an output to the Comm Port.
- 3) Print to Mem 2 – Automatic print data is redirected to data logging memory 2. Only pressing the Print key will generate an output to the Comm Port.
- 4) Auto Log Msg – When using the auto data logging features, the default Auto Log Message is on to alert the user that data has been stored. Use this mode for “Auto Print to Memory” modes with data storage that doesn’t occur very often. If using continuous printing to memory modes or other modes that happen rapidly, turn the “Auto Log Msg” off so that the message won’t interfere with other screen functions.

SECTION 11 – TEXT MESSAGING

The MSI-9750A provides a means for sending messages from host computers directly to the 9750A display. The remote computer uses a host command to send data to any 9750A on the same network (0-31). Once the 9750A receives a text message, it is displayed until a key is pressed. By including the standard ASCII bell character (control G), the message can also send an alert tone that persists until the message is acknowledged.

HOST MESSAGE DESIGN

The 9750A display is limited to 160 characters maximum. Characters beyond 160 characters will not be displayed. The size of the message characters is automatic and based on the length of the message. Messages shorter than 16 characters will be displayed in the large font in one or 2 rows (2 rows by 8 characters). Messages from 17 to 56 characters will be displayed in the medium font in 2 to 4 rows (4 rows by 14 characters). Messages longer than 56 characters will be displayed in the small font (8 rows by 20 characters). Words that cross line boundaries will be split.

In order for a host to send a message to an individual 9750A, the host must know the address of the 9750A. The string required for the host to transmit through a CellScale modem is:

MSGxxx*This is the transmitted text;

Where xxx is replaced by the address of the 9750A. It is not necessary to use three digits if the address is smaller.

Example1

(^ is used to designate a space)

Target 9750A address is 52, message is intended to be in large font on the 9750A screen.

MSG52*^POUR^5000 lb.;

The spaces are included to center the word “POUR” and to space the weight to the next line (8 total characters per line). This will result in a 9750A screen that appears like this:



```

POUR
5000 lb.

```

The message will flash to attract attention. This message will remain until any key is pressed on the 9750A.

Example2

Target 9750A address is 150, message is intended to be in medium font on the 9750A screen.

MSG150*Load 550kg.^Send to Loc^^B1234567890^^Warehouse 2;

The spaces are included to pad the first two lines (14 total characters per line) to prevent words breaking on the screen. This will result in a 9750A screen that appears like this:

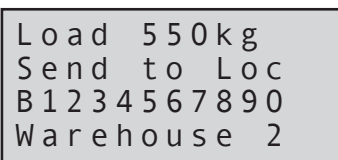

```

Load 550kg
Send to Loc
B1234567890
Warehouse 2

```

The message will flash to attract attention. This message will remain until any key is pressed on the 9750A.



9750A TO HOST MESSAGES

Once a sent message is observed by the 9750A user, pushing any key will clear the message and return the 9750A to the last display mode. An acknowledgment string is automatically sent back to the modem that generated the message. The acknowledgment string is programmed in the Comm Port Setup menu. The string defaults to the ASCII “ACK” character but can be modified in the “Enter/Edit Strings” choice of the Comm Port Setup menu.

The acknowledgment string includes the address of the 9750A in this form:

57:ttttt where “t t t t t” is the acknowledgment string.

9750A User Entered Message Reply

A function key can be designated to reply to Host messages in addition to the automatic acknowledgement. This allows the 9750A user to text message a reply or new message to any host computer. The 9750A can text message the host at any time, and can send to the last host that it received a message from. More than 1 Function key can be designated for messages and the user can choose to send to a specific CellScale RF or direct port or set it to reply to the last modem that sent a message.

To set up the 9750A to output a message:

- 1) Press Setup followed by “Function Keys” [1].
- 2) Select an unassigned or unneeded function key to program from the menu (1-6).
- 3) The “SELECT FOR Fx FROM” menu appears.
- 4) Select “Text Messaging” [6].
- 5) The next menu allows you to designate where the message should go. To send a message to the CellScale Comm 1 select [1]. To send a message to all connected comm ports (direct and RF) on the CellScale, select [2]. To send messages to Virtual RF connected Comm Ports 3, 4, or 5, select [3], [4], or [5]. To reply to the specific host port that last sent a message, select [6].
If more than 1 modem is attached to a single virtual host comm port (3, 4, or 5), the message will be sent to all modems on the message origin port.
- 6) Return to normal scale operation by pushing **ESC** twice.

SECTION 12 – BAR CODE

The Bar Code features of the 9750A allow the user to add scanned data to weight readings and trigger transmissions directly into RF connected computers. In combination with the Data Logging features, bar code scans can trigger data storage for uploading later.

Bar Code data is directed into text fields under user control. Two strings, K1 (Bar Code 1) and K2 (Bar Code 2) are sized to accept up to 64 bytes. In addition the bar code can be directed into ID Code strings 1 and 2 (20 bytes each) through the use of the function keys. Any string that can be entered via the keyboard can also be input via the bar code scanner. This degree of versatility allows such activities as operator ID, customer ID, product ID, etc., to be input via bar codes.

The MSI-9750A will interface directly to Bar Code scanners that use standard RS-232 output data. Power is supplied on pin 9 of the serial connector. The 9750A supplies a variable voltage output of 6 to 9 volts that is the switched output of the battery. Therefore a suitable bar code scanner must accept voltage over the stated range. The voltage output can be supplied as a regulated voltage (3.3 to 5V) by special order. Contact MSI for information on suitable scanners for your application.

BAR CODE SETUP MENU

The Bar Code Setup Menu is used to designate how Bar Code data is handled and sets minimum data size for each type of Bar Code string. Typically a function key is pressed to designate where the data is to go, then the Bar Code is scanned. By turning “AutoStart” on, any data coming in will go automatically into the Bar Code 1 buffer unless a bar code designated function key is pressed first. The typical operation will use Bar Code 1 for data that is scanned often, and designate function keys for additional data input. With AutoStart on hands free operation can be achieved just using the Bar Code scanner to initiate weight events with included Bar Code data. The Comm Port Setup Menu is used in conjunction with the Bar Code Menu to trigger remote printing/data storage events.



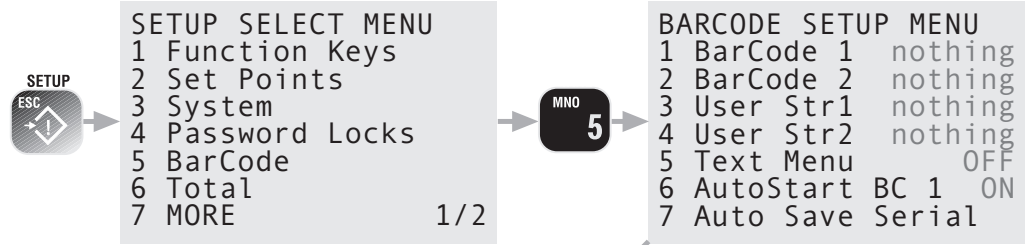

To set up the Bar Code reader, press **SETUP** then [5].

- 1) BarCode 1 – Designates the output mode when data comes in for Bar Code 1. [1] Selecting 1 will send the data to the master CellScale’s Comm Port 1. [2] Bar Code 1 data will be sent to all of the CellScales active ports, both direct connect, and RF connected. [3] BC1 data is sent to the CellScale RF Host 3. [4] BC1 data is sent to the CellScale RF Host 4. [5] BC1 data is sent to the CellScale RF Host 5. [6] BC1 data is sent to the transmit line on the 9750A Comm Port. [7] No action, the Bar Code data is stored in the Bar Code 1 buffer and is available for inclusion in print strings or sent to the display.
- 2) BarCode 2 – Same options as above.
- 3) User String 1 – The title here will change if the User String 1 function key was titled by the user. For example it might read “Operator” indicating the User String 1 is used to store an Operator ID. “Sent To” options are the same as above.
- 4) User String 2 – The title here will change if the User String 2 function key was titled by the user. For example it might read “Customer” indicating the User String 1 is used to store an Customer ID. “Sent To” options are the same as above.
- 5) Text Menu – Provides a means to control the 9750A with ASCII characters through the Comm Port. This must be set to “NONE” for the Bar Code Scanner to operate.
- 6) AutoStart BC1 – Turning “Auto Start Bar Code 1” on will designate any data coming in the Comm Port, while in the weight display mode, will automatically input into the Bar Code 1 buffer. This eliminates the need to first push a function key to tell the 9750A where to put the data.
- 7) Bar Code Auto Enter – Used to designate the minimum acceptable size of autoentered data. For example; Suppose the operator ID has to be 6 characters or more. By setting the Auto Enter size to 6, a bar code that is too small will not automatically enter into the designated string. The text entry screen will appear if the input code is too small, allowing the user to reject the data (press **ESC**), accept the data (press **ENTER**), or append to the data with the alphanumeric keypad.

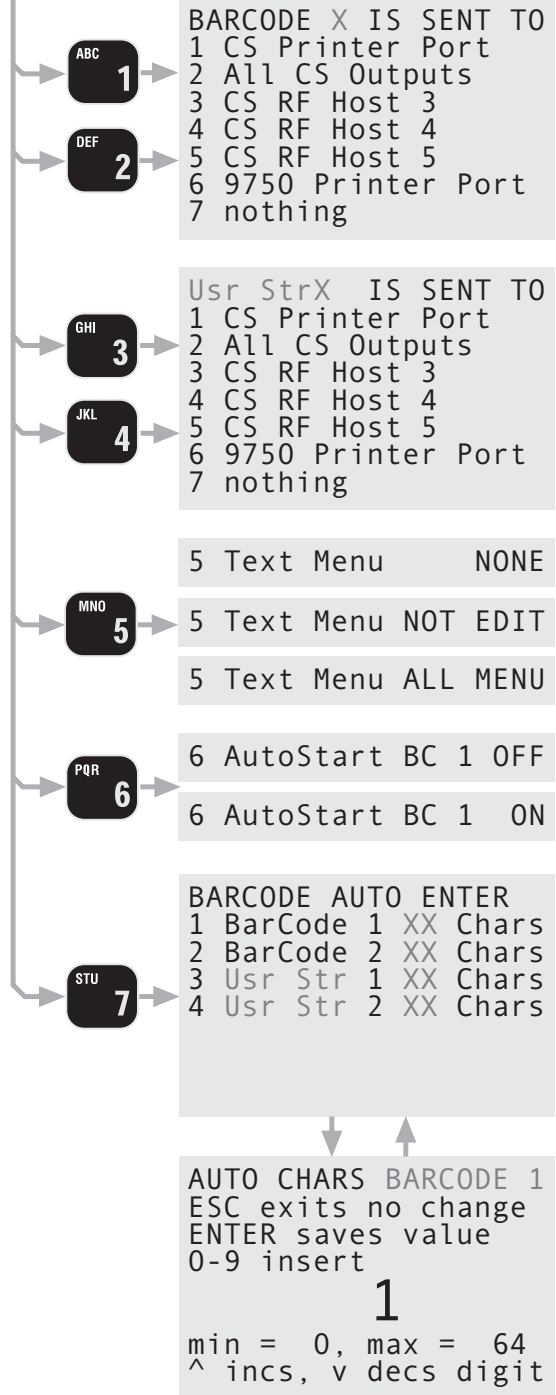

SECTION 13 – CHANNEL SETUP & CALIBRATION

CHANNEL SETUP MENU

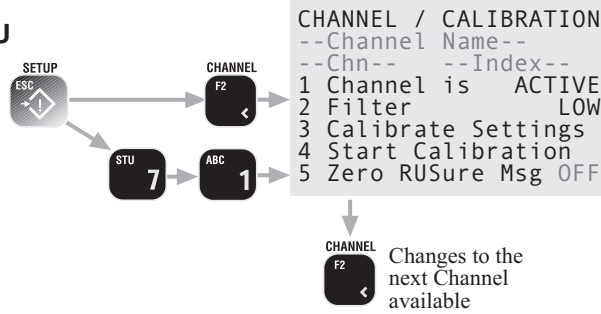

The Channel Setup Menu provides control of Channel settings in the CellScale. The CHANNEL / CALIBRATION menu screen will display the current channel name (if it was provided in the CellScale), channel number and scan list index number.

- [1] Channel is ACTIVE / INACTIVE – The Channel is operating as part of the Scan List if ACTIVE. If set INACTIVE, the channel will not be available to any device in the Network, and will not be displayed on the 9750A.
- [2] Filter – Each A/D channel has independent filtering set by this menu. Set “Low” for normal scales, Medium or High for scales that are subject to a lot of movement or vibration, or for very high resolution scales. This menu is locked out in L-F-T systems until the calibration switch is enabled at the CellScale.
- [3] Calibrate Settings – See following submenu description. This menu is locked out in L-F-T systems until the calibration switch is enabled at the CellScale.
- [4] Start Calibration – Starts the Calibration Procedure. This menu is locked out in L-F-T systems until the calibration switch is enabled at the CellScale.

CALIBRATE SETTINGS

- [1] Motion Compensation – For CellScales equipped with the Motion Compensation option only. Described in detail in “MOTION COMPENSATION CALIBRATION”.
- [2] Motion Band – The motion band determines the range of weight variation that the indicator considers to be stable weight. Selecting “Motion Band” calls a numeric entry screen.
- [3] Scale Cal Standard – The submenu has 4 choices: Industrial [1] No limits on settings. NIST NTEP [2] Settings limited to NTEP ranges, calibration is protected by the CellScale Sealed Switch. OIML R76 [3] Settings limited to R76 ranges, only metric units allowed. Industrial Metric [4] Same as 1 except only metric units allowed.
- [4] Center of Zero ON/OFF – Enables the Center of Zero annunciator. The scale is within 1/4 d of center when the annunciator is on.
- [5] Autozero (AZM) ON/OFF – Enables and disables Auto Zero Maintenance (AZM).
- [6] Autozero Band – Calls a numeric entry screen to set up the range of weight in ‘d’ that is automatically zeroed. Typical settings for the AZM band are ±1d for most applications, ±3d for truck scales, and ±.6d for L-F-T applications (reached by setting the band to 0)

1 Channel is ACTIVE
1 Chan is INACTIVE

CHANNEL FILTER
1▶Low
2 Medium
3 High

DEF 2

CALIBRATE -CHN- SETTINGS
1 Motion Comp OFF
2 Motion Band 0d
3 Standard INDUSTRY
4 Center of Zero OFF
5 AutoZero (AZM) OFF
6 AZM Band 1d

GHI 3

JKL 4

Starts the Calibration Procedure
5 Zero RUSure Msg ON
5 Zero RUSure Msg OFF

MNO 5

ABC 1

MOTION COMPENSATION
1 Mode ACTUAL
2 Position DISABLED
3 User Wt 0.0 lb
4 MSI Wt 70.0 lb

DEF 2

SET MOTION BAND (d)
ESC exits no change
ENTER saves value
0-9 replaces value
10
min = 0 max = 255
^ incs, v decs digit

GHI 3

SCALE CAL STANDARD
1 Industrial (unreg)
2 NIST NTEP
3 OIML R76
4 Industrial Metric

JKL 4

4 Center of Zero ON
4 Center of Zero OFF
5 Autozero (AZM) ON
5 Autozero (AZM) OFF

MNO 5

PQR 6

AUTOZERO BAND (d)
ESC exits no change
ENTER saves value
0-9 replaces value
10
min = 0 max = 255
^ incs, v decs digit



CALIBRATE GENERAL INFORMATION

The following sections are intended for qualified scale technicians. The CellScale can be calibrated either directly using the Terminal Interface mode, or by using a 9750A or 3750CS. See the CellScale operators guide for information on direct calibration. This section details the calibration of a CellScale using the 9750A RF Remote Indicator. Calibrating a CellScale with a 9750A requires that adequate test weights (at least 10% of capacity) are available. The CellScale is capable of multi-point calibration with any combination of weights from zero to capacity.

Calibration constants are stored only in the CellScale. The 9750A serves only as a controller during calibration. Since a single CellScale is capable of hosting up to 32 independent scales, the scale channel to be calibrated must be selected first using the CHANNEL Key. To Calibrate multiple Scale Inputs, you must complete the first calibration. Then exit out of the Calibration Menus. Select the next scale with the CHANNEL Key. Then enable Calibration again.

ENABLE CALIBRATION

Calibration of a CellScale from the 9750A may be protected in either of two ways: 1) Legal-for-Trade systems are protected with a sealed push button switch on the CellScale. This switch must be pressed to enable the calibration menus. 2) The 9750A also offers password locks to prevent calibration. See the Password locks section for information on how to set passwords.

Industrial use scales are not required to have the calibration protected. However MSI recommends using the Password locks to prevent accidental calibrations.

To Enable Calibration (Legal-for-Trade CellScales Only)

- 1) Expose the Calibration Seal Port by removing the seal screw on the CellScale with a Phillips Head Screwdriver. Seal Screw location can be found in the CellScale manual or the 9300 Crane Scale Manual.
- 2) Insert a small non-metallic screwdriver or the wooden stem of a “Q-Tip” and press and release the switch button in the hole. The CellScale will acknowledge the press button by flashing its LEDs.
- 3) Now you can proceed with calibration and calibration settings.

TO CALIBRATE

Use this Calibration procedure for calibration of the CellScale using the 9750A. The CellScale supports 10 point calibration - zero and up to 9 points of span calibration. Zero and at least 1 span point are required for a successful calibration. The highest value test weight should be at least 10% of capacity, but 50% or more is preferable.

Calibration Procedure

- 1) Multichannel systems only - Using the **CHANNEL** key, step to the Scale channel you wish to calibrate. Only A/D channels can be calibrated (1-x, 2-x, 3-x, and 4-x). Do not attempt to calibrate a math channel (6-x).
- 2) Press **SETUP** followed by **CHANNEL**, or **SETUP**, “MORE” [7], and select “Channel / Calibration” [1].
- 3) Select “Start Calibration” [4].
- 4) If this is a re calibration, press **ENTER** and jump to step 9. If this is a new installation, or you wish to change the capacity and/or scale division size, press **CLR (ZERO)**.
- 5) The screen displays “RESETTING CALIBRATION” a few seconds while the calibration memory is purged.
- 6) Select a calibration unit by pressing 1-7. This should be in the units the scale is most commonly used in. However, sometimes it is desirable to use the units your test weights are cal’d in for convenience in number entry. You can always change the units for display later.
- 7) Enter the capacity of the scale (in the cal unit selected) using the numeric keypad. Press **ENTER**.
- 8) The CellScale calculates the appropriate scale divisions based on allowed resolution and then sends them to the 9750A as a list. The “SCALE DIVISIONS (d)” menu will vary depending on capacity and units. From 5 to 12 possible divisions will be shown. Pick the rated scale division for your scale.
Avoid excess total divisions (capacity/d = total divisions) for the type of scale you are using. Crane scales should be less than 5000 total divisions and depending on usage sometimes less than 1000 divisions. Platform scales are rarely accurate above 10000 divisions. Lower resolution means faster settling time, and a more stable display in vibration and motion situations.
- 9) “ZERO CALIBRATION” – Unload the scale. When the scale is stable press **ENTER**. There will be a short delay while the A/D in the CellScale performs all its initializations.

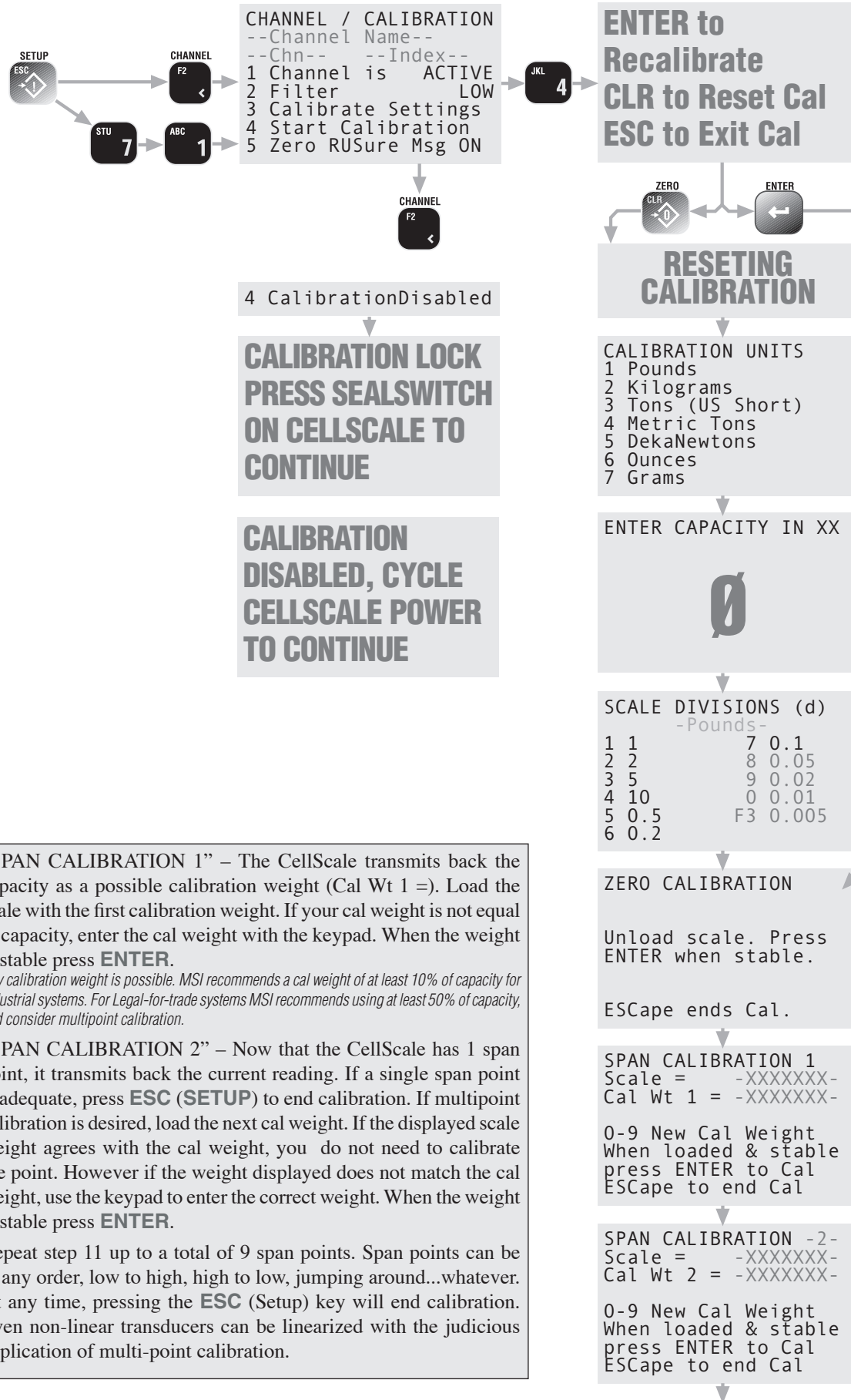

- 10) "SPAN CALIBRATION 1" – The CellScale transmits back the capacity as a possible calibration weight (Cal Wt 1 =). Load the scale with the first calibration weight. If your cal weight is not equal to capacity, enter the cal weight with the keypad. When the weight is stable press **ENTER**.
Any calibration weight is possible. MSI recommends a cal weight of at least 10% of capacity for industrial systems. For Legal-for-trade systems MSI recommends using at least 50% of capacity, and consider multipoint calibration.
- 11) "SPAN CALIBRATION 2" – Now that the CellScale has 1 span point, it transmits back the current reading. If a single span point is adequate, press **ESC (SETUP)** to end calibration. If multipoint calibration is desired, load the next cal weight. If the displayed scale weight agrees with the cal weight, you do not need to calibrate the point. However if the weight displayed does not match the cal weight, use the keypad to enter the correct weight. When the weight is stable press **ENTER**.
- 12) Repeat step 11 up to a total of 9 span points. Span points can be in any order, low to high, high to low, jumping around...whatever. At any time, pressing the **ESC (Setup)** key will end calibration. Even non-linear transducers can be linearized with the judicious application of multi-point calibration.



TO ENABLE / DISABLE AZM (AUTO ZERO MAINTENANCE)

AZM is used to adjust out variations at zero caused by debris or water on the scale, temperature drift, and any other minor variation that affects the zero setting. Typically AZM is set to 0.5d or 1d, which is adequate for most modern scale systems. The CellScale allows for a much greater AZM range (non legal-for-trade scales only) for unique applications. Use this feature cautiously as it can zero out large weight amounts unexpectedly.

An example of where a large value AZM can be advantageous is when packing produce. Typically there is some variation in the weight of the packing boxes. By setting the AZM to equal the largest variation in box weight, the error in weight caused by the box variations can be eliminated automatically. The key to making this work is that the first amount of produce placed in the box has to weigh more than the AZM range so that the produce isn't also zeroed out.

The CellScale can also adjust the time interval of AZM, but only through the Terminal Interface (refer to the CellScale manual). AZM time interval defaults to 1/second.

To ENABLE / DISABLE AZM and set the AZM Capture Band

- 1) Press **SETUP**, then **CHANNEL**.
- 2) Select "Calibration Settings" [3].
- 3) Toggle AZM on or off with the [5] key.
- 4) The AZM capture band is listed on the selection 6 line. If a different capture band is desired, press [6].
- 5) On the "AUTOZERO BAND" screen, set the size in scale division of the AZM capture band. The number represents the positive and negative capture range. Entering 0 equals a capture range of ± 0.5 d. Entering 5 represents a capture range of ± 5 d. Press the **ENTER** key to store the AZM Band value.
- 6) Press **DISPLAY** to return to the Scale Display. Press **ESC** to return to the "CHANNEL / CALIBRATION" menu.



Do not disable AZM. The ability to disable AZM is only intended for regulatory agencies that conduct tests without AZM enabled. Disabling AZM will degrade temperature and drift performance of the CellScale. Also use caution in setting the AZM window too large. This can cause the scale to zero unexpectedly. MSI recommends keeping AZM

MOTION BAND

The motion band determines the range of weight variation that the indicator considers to be stable weight. Since the CellScale will not zero or tare a value in motion, the motion band directly influences the accuracy of the scale system. The motion band in Legal-For-Trade systems is usually limited to $\leq 0.6d$ but sometimes up to $\pm 3d$ in certain types of installations. In systems used for industrial applications, the motion band can be adjusted larger. Adjusting the motion band larger can help in medium accuracy applications where there is a lot of vibration or noise and it is difficult to hold the weight steady enough to tare, zero, or total. For example, setting the motion band to 5 d would allow a tare (or zero or total) to be as much as 5d off of its ideal value but it will make the indicator easier to use as you don't have to wait until the weight is completely stable.

The Motion Band \pm range is limited to a maximum of ± 255 'd'. If you exceed this range, the 9750A will set the value to 255 'd'. Setting the Motion Band to 0 is equal to a range of $\pm 0.6d$.

To Adjust the Motion Band

- 1) Press **SETUP**, then **CHANNEL**.
- 2) Select "Calibration Settings" [3].
- 3) From the "CALIBRATE SETTINGS" menu, select "Motion Band" [2].
- 4) On the "SET MOTION BAND" screen, set the size in scale division of the AZM capture band. The number represents the \pm band of motion detection. Entering 0 equals a motion band of ± 0.6 d. Entering 3 represents a motion band of ± 3 d. Press the **ENTER** key to store the Motion Band value.
- 5) Press **DISPLAY** to return to the Scale Display, or press **ESC** to return to the "CHANNEL / CALIBRATION" menu.

CENTER-OF-ZERO (COZ) INDICATOR

The COZ indicator turns on when the scale is within 1/4 d of the last zero setting. Some legal-for-trade jurisdictions require its use.

To Enable/Disable the COZ Indicator

Before starting the following procedure, you must be in the Top Menu Level of Calibration.

- 1) Press **SETUP**, then **CHANNEL**.
- 2) Select “Calibration Settings” [3].
- 3) Toggle the Center of Zero indicator on or off with the [4] key.
- 4) Press **DISPLAY** to return to the Scale Display. Press **ESC** to return to the “CHANNEL / CALIBRATION” menu.

SETTING UP THE MOTION COMPENSATION OPTION

The Motion Compensation Option is an advanced CellScale feature that uses an Accelerometer to measure motion and tilt angle. Successful use of the option is dependent on the setup parameters and configuration of the electronics. Refer to the Menu Map on page 94 for structure of the Motion Comp setup menus.

Configuration of the Compensation data depends on user input:

- 1) **POSITION** – The relative position of the Motion Comp Module must also be known. In the case of a standard Cell Scale the diagram on the next page should be used.
- 2) **MODE** – This should usually be set to “SMART”. Use of the “ACTUAL” setting requires specific knowledge of the internal workings of the CellScale A/D parameters that are only accessible through the terminal interface. Contact MSI for additional information.
- 3) **MSI WT** – The user must know the active weight (MSI WT) of the scale itself. This number is not easy to determine, and is usually provided by MSI for MSI designed load trains. For load cell systems not supplied by MSI, please contact MSI for details on determining the active weight.
The MSI weight is found on MSI’s serial number tag. It is referenced as the “COMP WEIGHT” and is usually measured in pounds. Make sure you convert this weight if the scale is calibrated in units other than pounds.
- 4) **USER WT** – The user must also know the dead load weight (USER WT) of the scale. The dead load is a weight that is normally zeroed out, but in a motion compensated system this weight must be known to a high degree of accuracy. Weighing the scale elements on another calibrated scale is one way to determine the dead load.

To Setup the Motion Compensation Option

- 1) Press **SETUP**, then **CHANNEL**.
- 2) Select “Calibration Settings” [3].
- 3) From the “CALIBRATE SETTINGS” menu, select “Motion Compensation” [1].
- 4) Use the [1] key to scroll between “SMART”, “ACTUAL” or “DISABLED”.
- 5) The current setting for Motion Compensation position is displayed at selection 2. Press [2] to change.
- 6) For this example, we’ll set the position to “SIDE D UP” [5].
For MCS and OMS Scrap loading systems use “D”. For MSI DJJ three chain systems, use “A”. For motion compensated TransWeigh CS systems use “D”. Refer to the drawing on the following page for CellScale orientation.
- 7) Press **ENTER** to set your position choice.
- 8) Use the [3] key to bring up a weight entry screen for the “MSI Weight”.
- 9) Input the “MSI WT”. This weight is usually found on the motion compensated scales label.
Make sure that the MSI WT is in the displayed units. If not convert the MSI WT to the calibration unit as shown on the display.
- 10) Press **ENTER**. The current set MSI WT is set and you are returned to the previous menu.
- 11) Use the [4] key to bring up a weight entry screen for the “User Weight”.
- 12) Input the “USER WT”. This weight is usually found on the motion compensated scales label.
The USER WT is equivalent to the dead load of the scale. In MCS and OMS systems, the USER WT is the weight of the magnet and chains beneath the scale.
- 13) Press **ENTER**. The current USER WT is set and you are returned to the previous menu.
- 14) Press **ESC**. You are now back in the “CAL SETUP” menu. Perform another cal function, or press **EXIT** to return to weight reading with the new Motion Compensation parameters.



CELLSCALE SIDE ORIENTATION

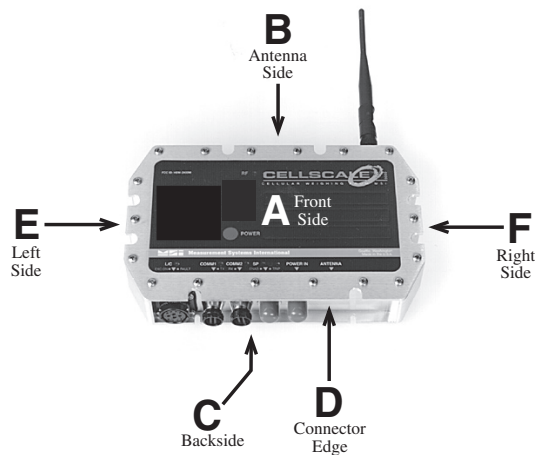

RESET ALL

This procedure returns all registers of the 9750A to defaults. **DO NOT** initiate this function unless you are prepared and qualified to perform a complete setup of the 9750A system. This operation does not clear calibrations or affect any connected CellScales.

To Completely Reset the 9750A

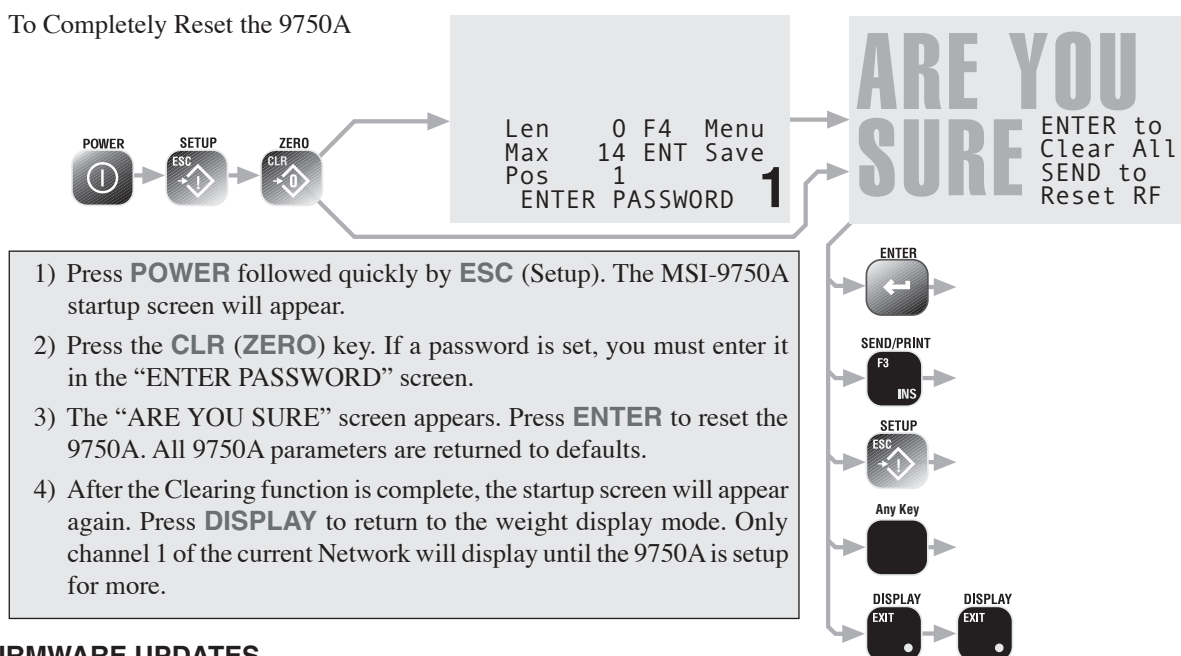

- 1) Press **POWER** followed quickly by **ESC** (Setup). The MSI-9750A startup screen will appear.
- 2) Press the **CLR (ZERO)** key. If a password is set, you must enter it in the “ENTER PASSWORD” screen.
- 3) The “ARE YOU SURE” screen appears. Press **ENTER** to reset the 9750A. All 9750A parameters are returned to defaults.
- 4) After the Clearing function is complete, the startup screen will appear again. Press **DISPLAY** to return to the weight display mode. Only channel 1 of the current Network will display until the 9750A is setup for more.

INSTALLING FIRMWARE UPDATES



The 9750A contains Flash memory that allows the firmware to be upgraded through the Comm Port. A “Boot Loader” program is used to load a new program file into the 9750. MSI will update and improve the 9750A feature set over time and provide program updates free of charge. Please see MSI’s web page (www.msiscales.com) to download the most current 9750A firmware.

This process completely destroys 9750A setups and erases data logging memory. It does not affect CellScale calibration in any way.

Using 9750A Bootloader

- 1) Set a terminal program to emulate an ASCII terminal.
- 2) Set the Baud rate to 9600 Baud, 8 data bits, 1 stop bit, and no parity.
- 3) Set the data transfer protocol to ASCII.
- 4) Connect the 9750A to the PC serial port with a null modem cable.
- 5) Starting with the 9750A off, press and hold the 9750’s **[ABC1]** key.
- 6) When the “Push Power to Continue” screen appears, release the **[ABC1]** key.
- 7) The “MSI Software Installer” screen will appear on the 9750A, and the Bootloader menu will appear on the terminal screen.

```

MSI Boot Loader Version 3.K3

(1)    Update Application
(2)    Change Baud Rate
(ESC)  Start Application

Enter Command :
    
```

8) Choosing a faster baud rate will decrease the amount of time required to complete the update. However, baud rates above 38400 usually require a 5 wire serial cable (include RTS and CTS) and a terminal program that supports hardware handshaking. Press [2] on the terminal keyboard to change baud rate.

```

Baud Change menu

(1)    9600   Baud
(2)    19200 Baud
(3)    38400 Baud
(4)    57600 Baud
(5)    115200 Baud
(ESC)  Exit

Choose a baud rate, then
change your terminal's baud rate.

If you encounter problems, reset your
terminal to 9600 Baud and re-start.

Choose now :
    
```

9) In this example, choose [4] 57.6K baud. This will immediately change the baud rate of the CellScale. It will transmit "When you can read this, press any key." Change the baud rate of your terminal program to match. Until you do the message will be garbage characters. When the message is legible due to matching baud rates, press any key to return to the main menu.

```

_+)#!!!_+)#!!!_+)#!!!_+)#!!!_+)#!!!_+)#!!!_+)#!!!_+)#!!!_
#!!!_+)#!!!_+)#!!!_+)#!!!_+)#!!!_+)#!!!_+)#!!!_+)#!!!_
      When you can read this, press any key.          before matching baud rates
rates
      When you can read this, press any key.          after matching baud
      When you can read this, press any key.
    
```

```

MSI Boot Loader Version 3.K3

(1)    Update Application
(2)    Change Baud Rate
(ESC)  Start Application

Enter Command :
    
```

10) Choosing "Update Application" will request that the file be uploaded.

```

Send (Upload) the file :
    
```

11) Use the terminal upload utility (part of your terminal program) to send the file. Monitor progress on the terminal screen. The number to the left of the screen is the upload sector value.



```
xxxx  Send (Upload) the file
```

During Bootloading, the 9750A will display this screen

```

MSI Software Installer
BOOTLOADING
Please Wait
Press any key to abort

```

When the upload is complete the following will appear in the PC Terminal window.

```

CBFF  Send (Upload) the file :
      Upload complete
      Erasing sector 1 of 7
      Erasing sector 2 of 7
      Erasing sector 3 of 7
      Erasing sector 4 of 7
      Erasing sector 5 of 7
      Erasing sector 6 of 7
      Erasing sector 7 of 7
      Erase Complete
      Programming sector 1 of 7.....
      Programming sector 2 of 7.....
      Programming sector 3 of 7.....
      Programming sector 4 of 7.....
      Programming sector 5 of 7.....
      Programming sector 6 of 7.....
      Programming sector 7 of 7.....
      Programming Complete

```

Do not press any keys on the 9750A during the erasing and programming phase. When finished the terminal will return to the main bootloader screen, allowing you an opportunity to repeat the upload if necessary.

```
MSI Boot Loader Version 3.K3
```

```

(1)    Update Application
(2)    Change Baud Rate
(ESC)  Start Application

```

- 12) After all sectors are programmed, press the **POWER** key on the 9750A. The 9750A will turn off. Remove the serial cable from the 9750A Comm Port.
- 13) Turn the 9750A back on. The 9750A display will read "CLEARING" while it initializes all setup registers.
- 14) Restore display and other system parameters as needed. RF Modem network parameters for the last RF Network used are not usually affected by the bootloading process. However, multiple RF Network settings will have to be reprogrammed.

APPENDIX A – MENU MAPS

SETUP SELECT MENU

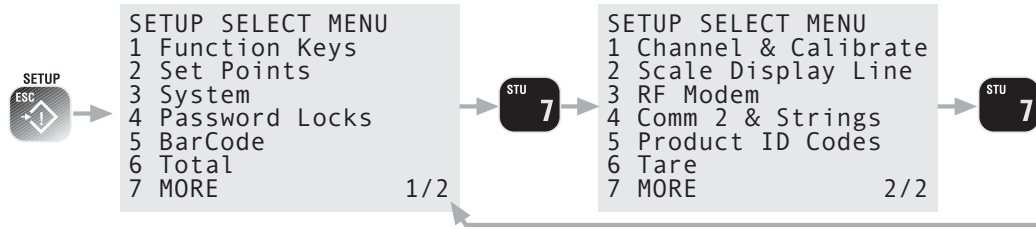

PASSWORD LOCKS

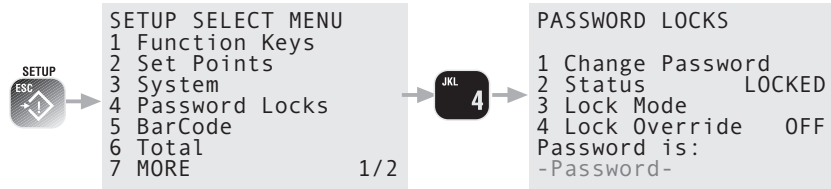

TOTAL SETTINGS

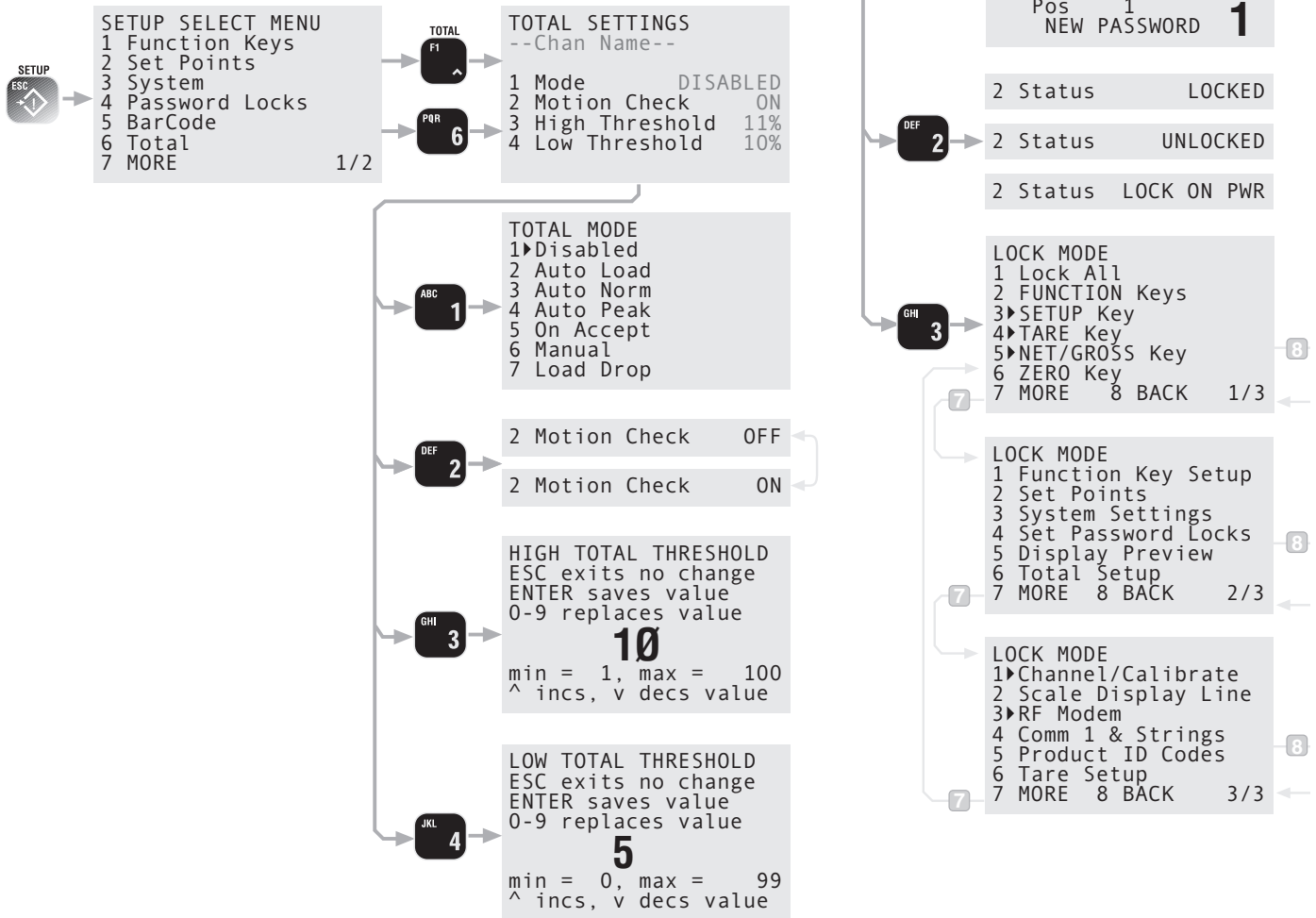



FUNCTION KEYS

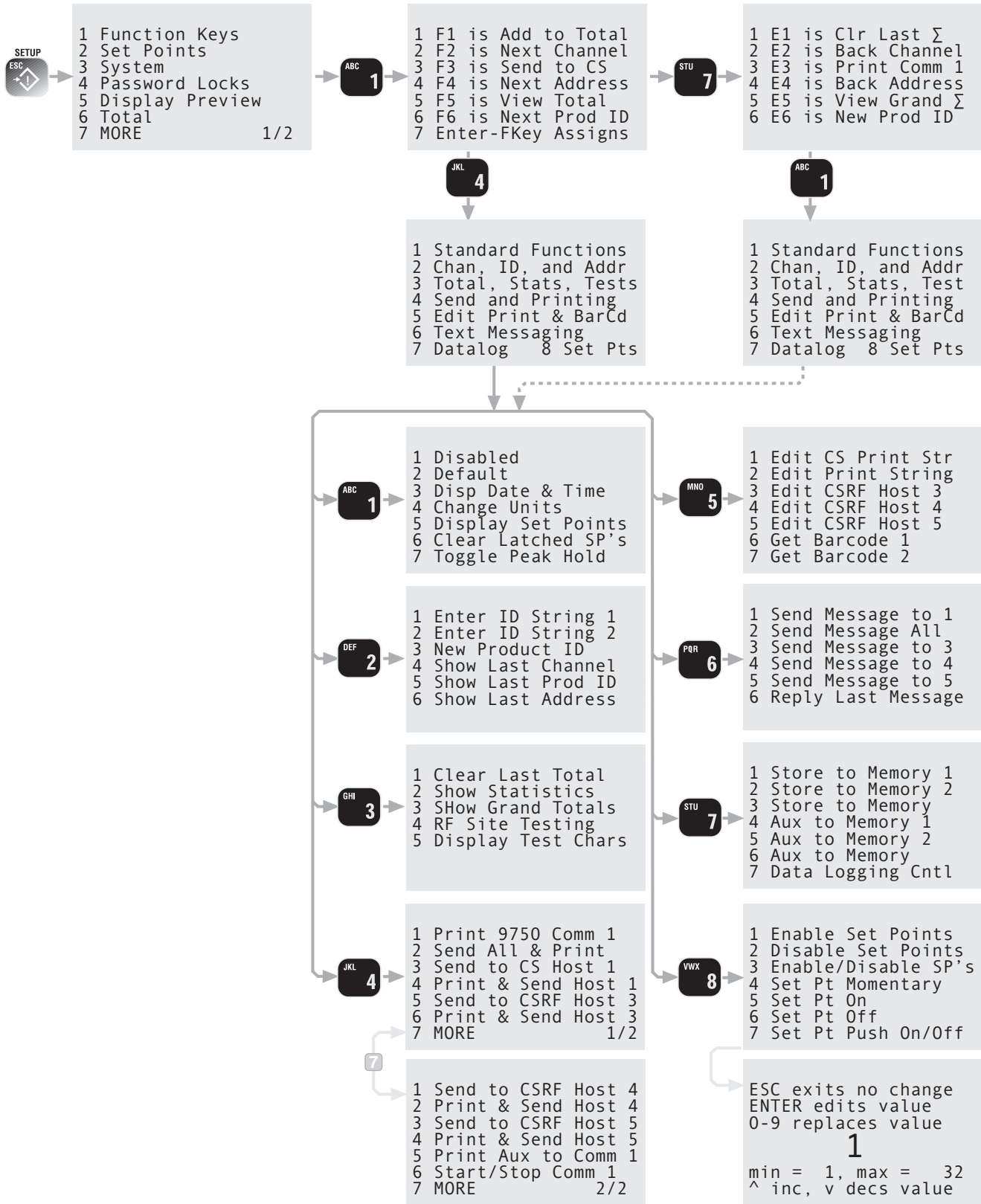

SERIAL & STRINGS

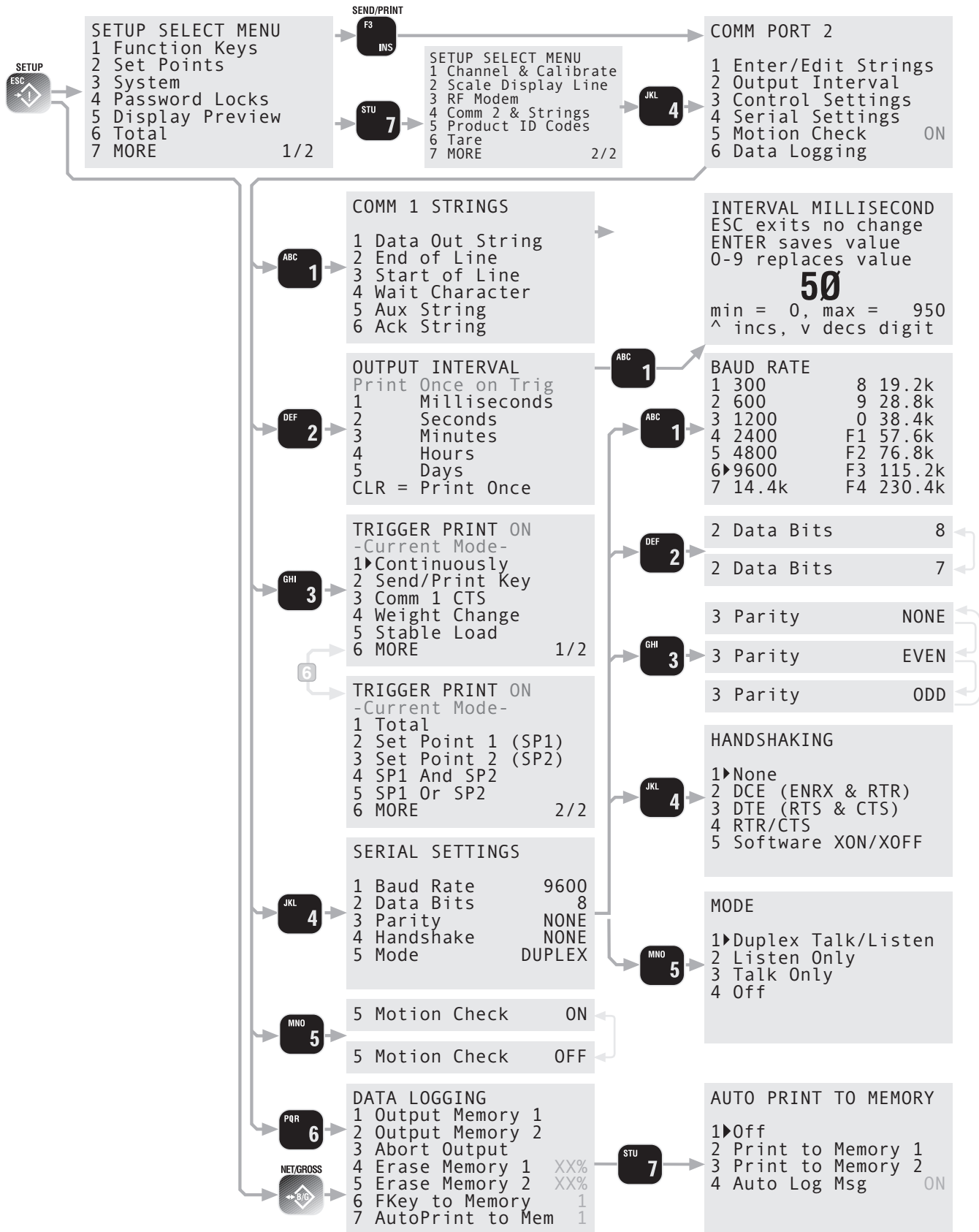



PRODUCT ID CODES

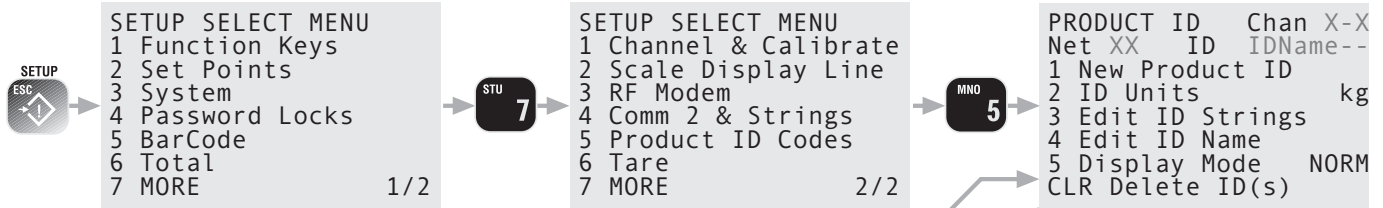

BAR CODE SETUP

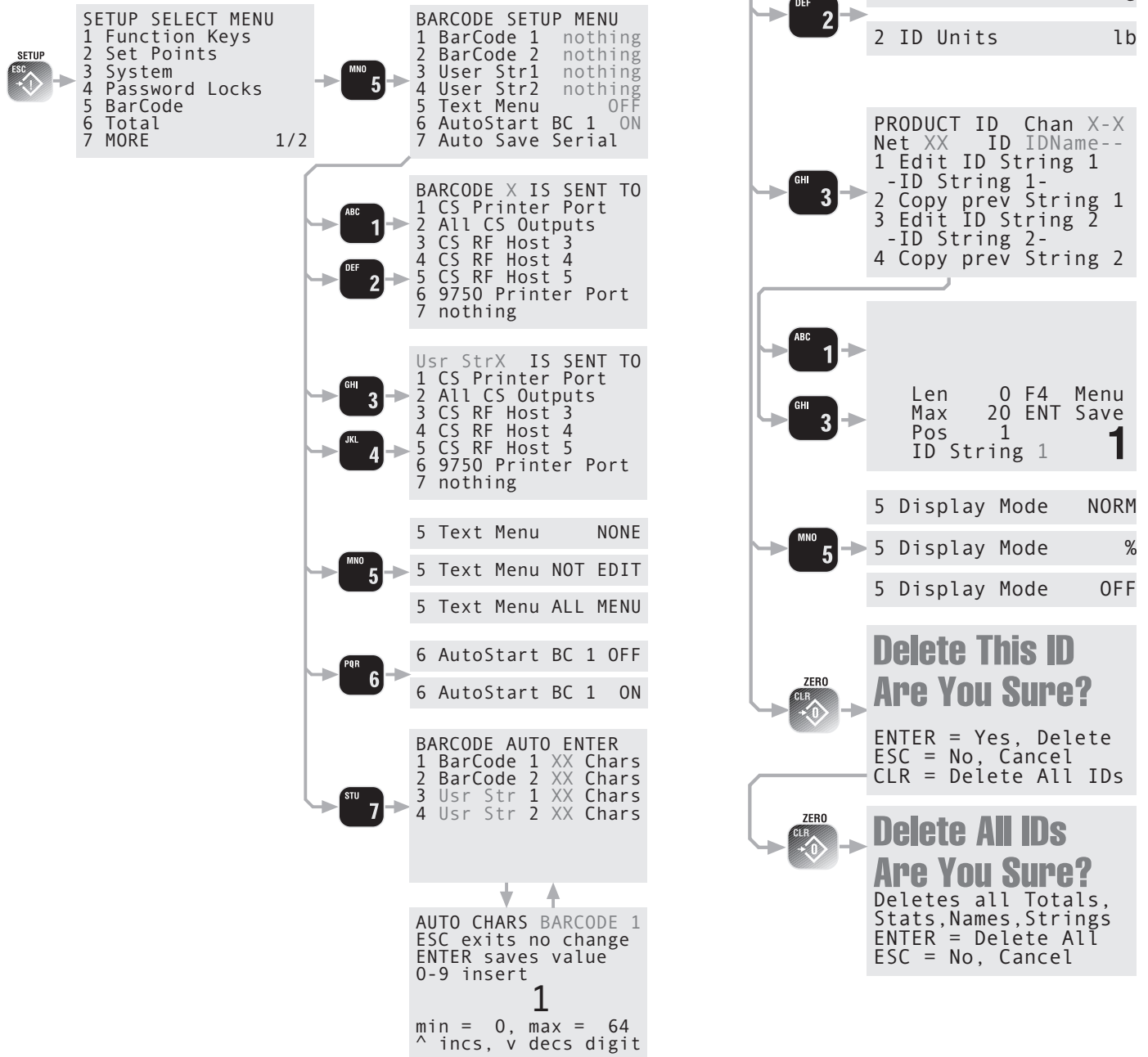

TARE SETTINGS

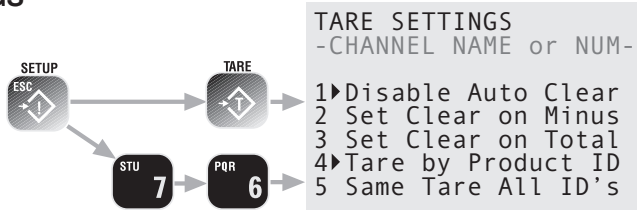

RF MODEM SETTINGS

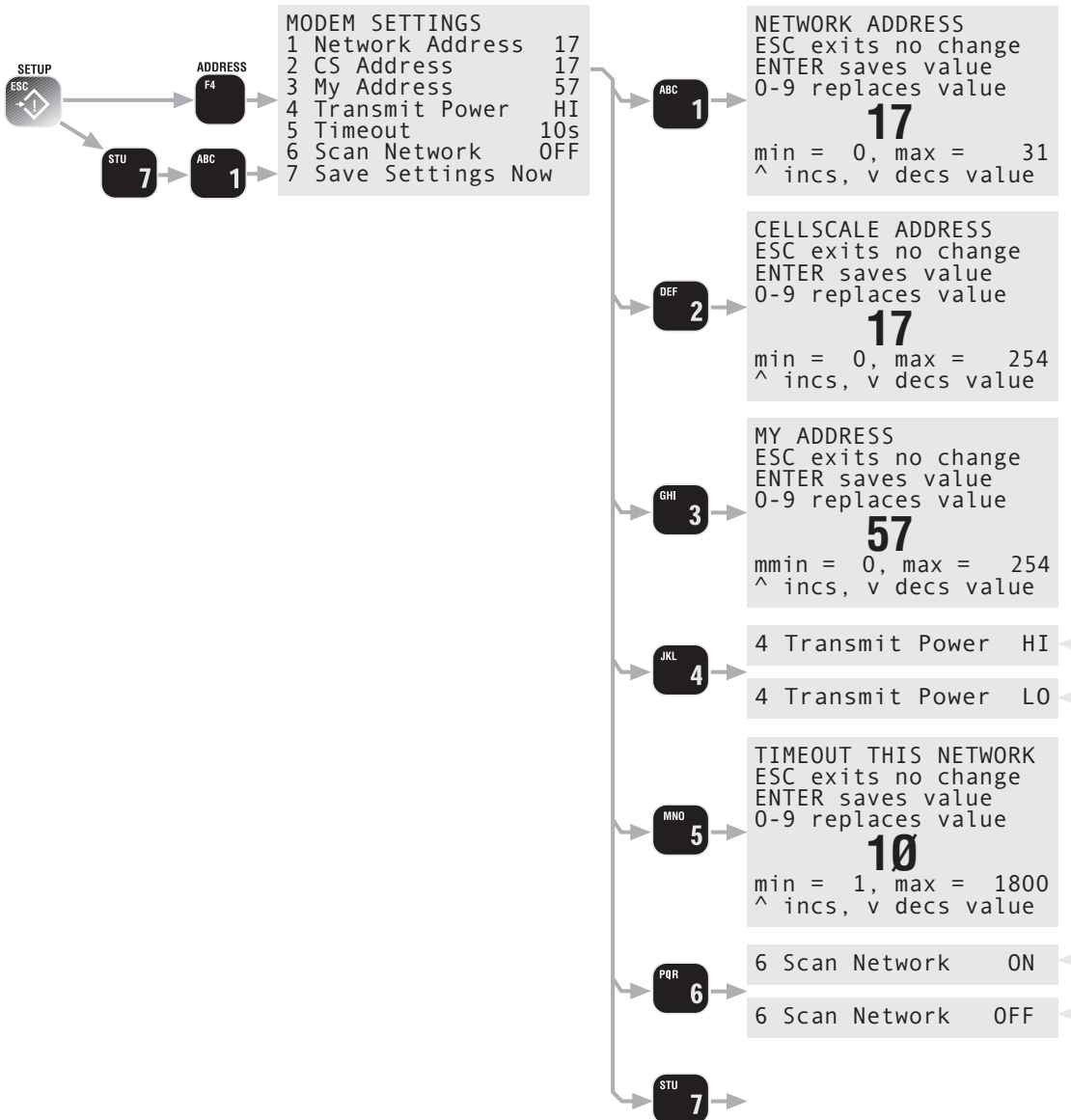



SCALE DISPLAY SETUP

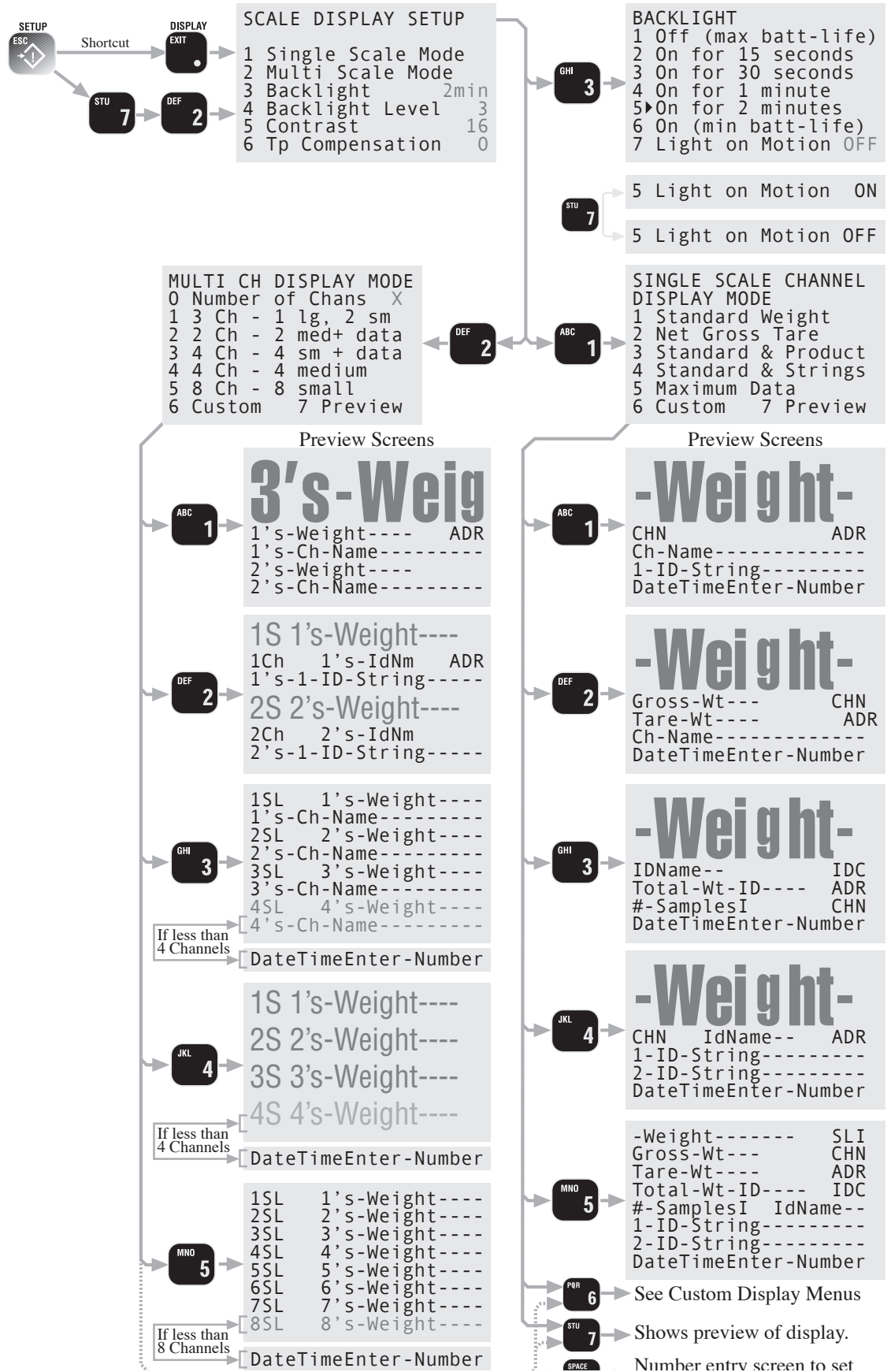

SCALE SINGLE CHANNEL CUSTOM DISPLAY SETUP

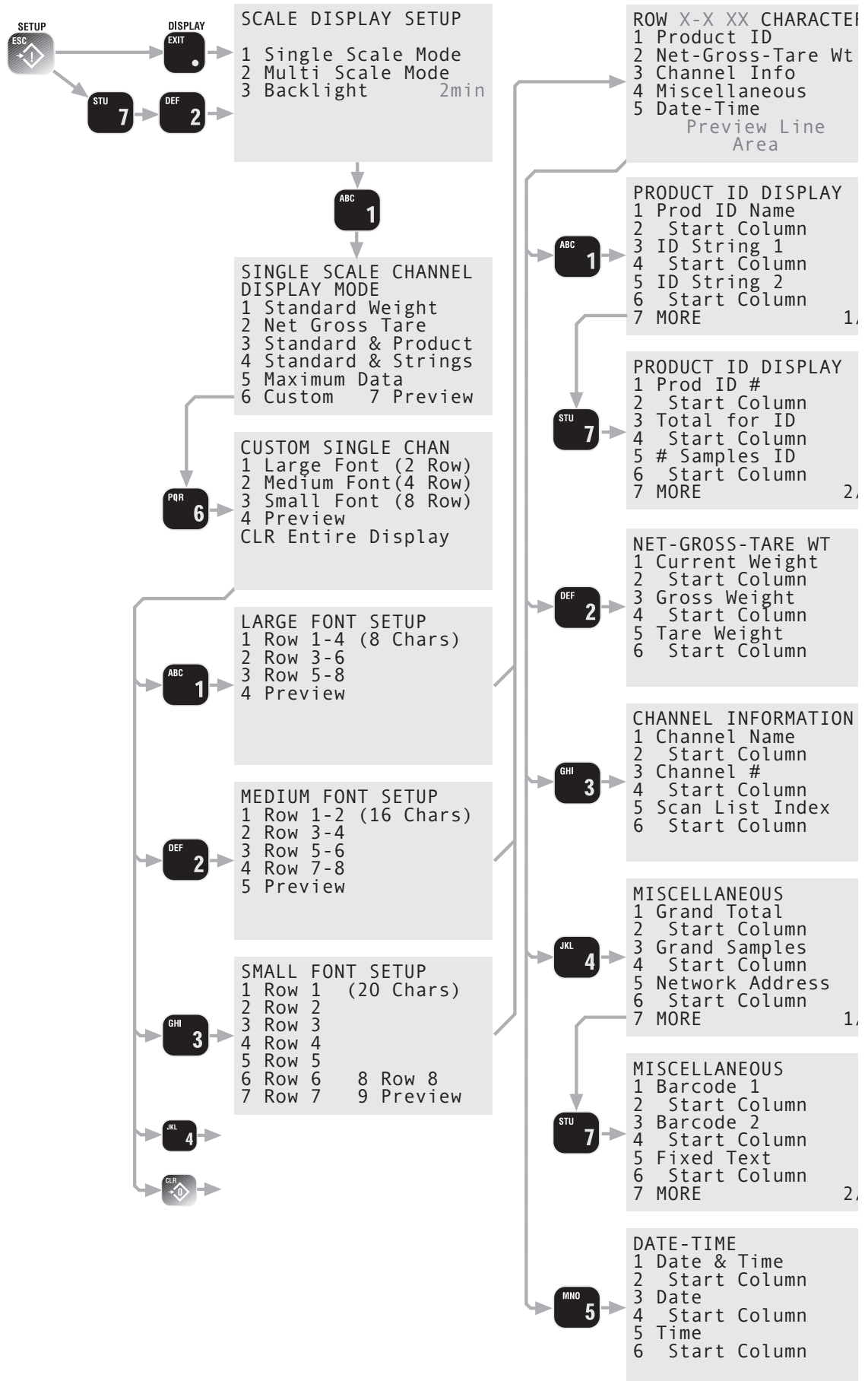



SCALE MULTI-CHANNEL CUSTOM DISPLAY SETUP

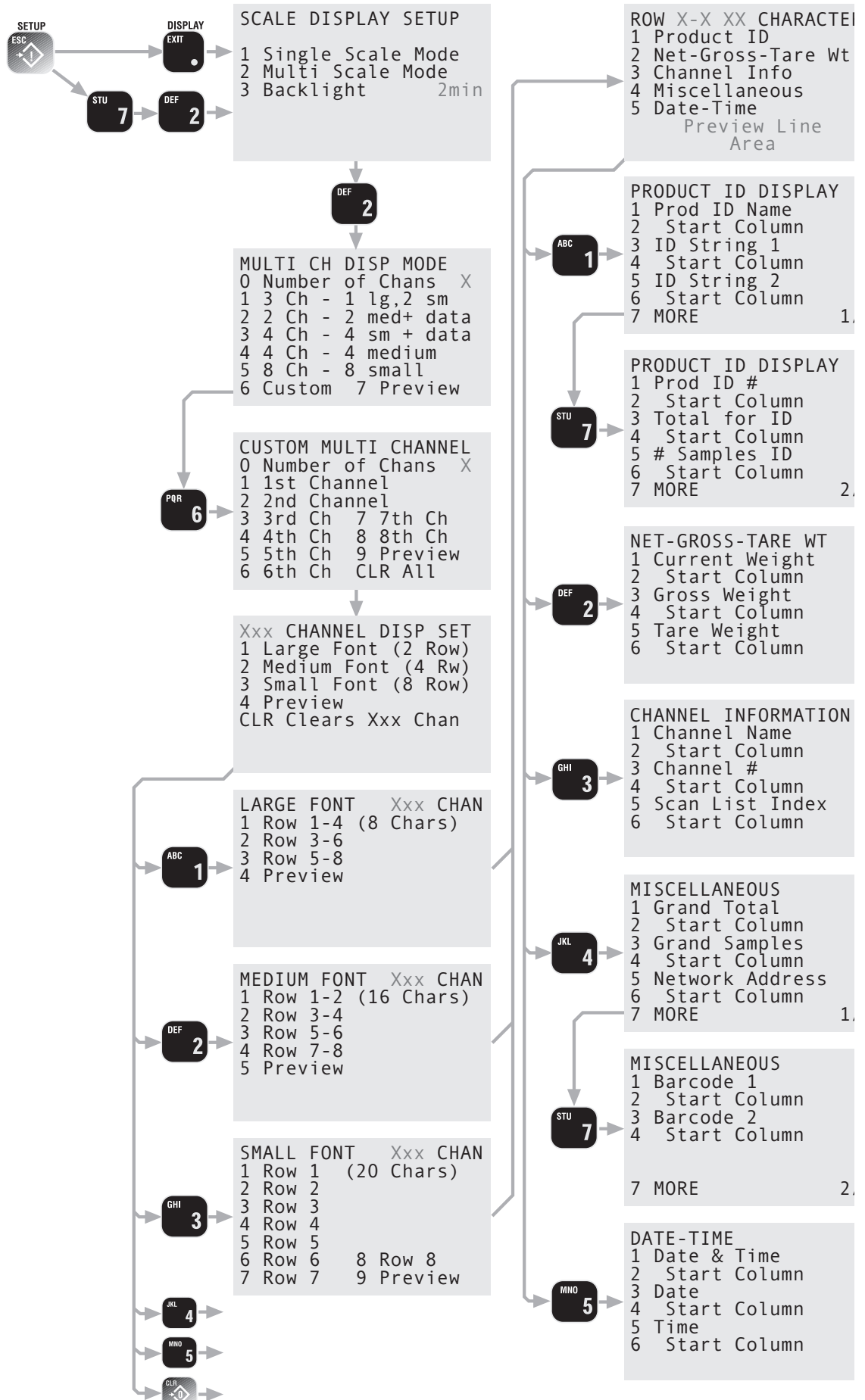

CHANNEL / CALIBRATE SETTINGS

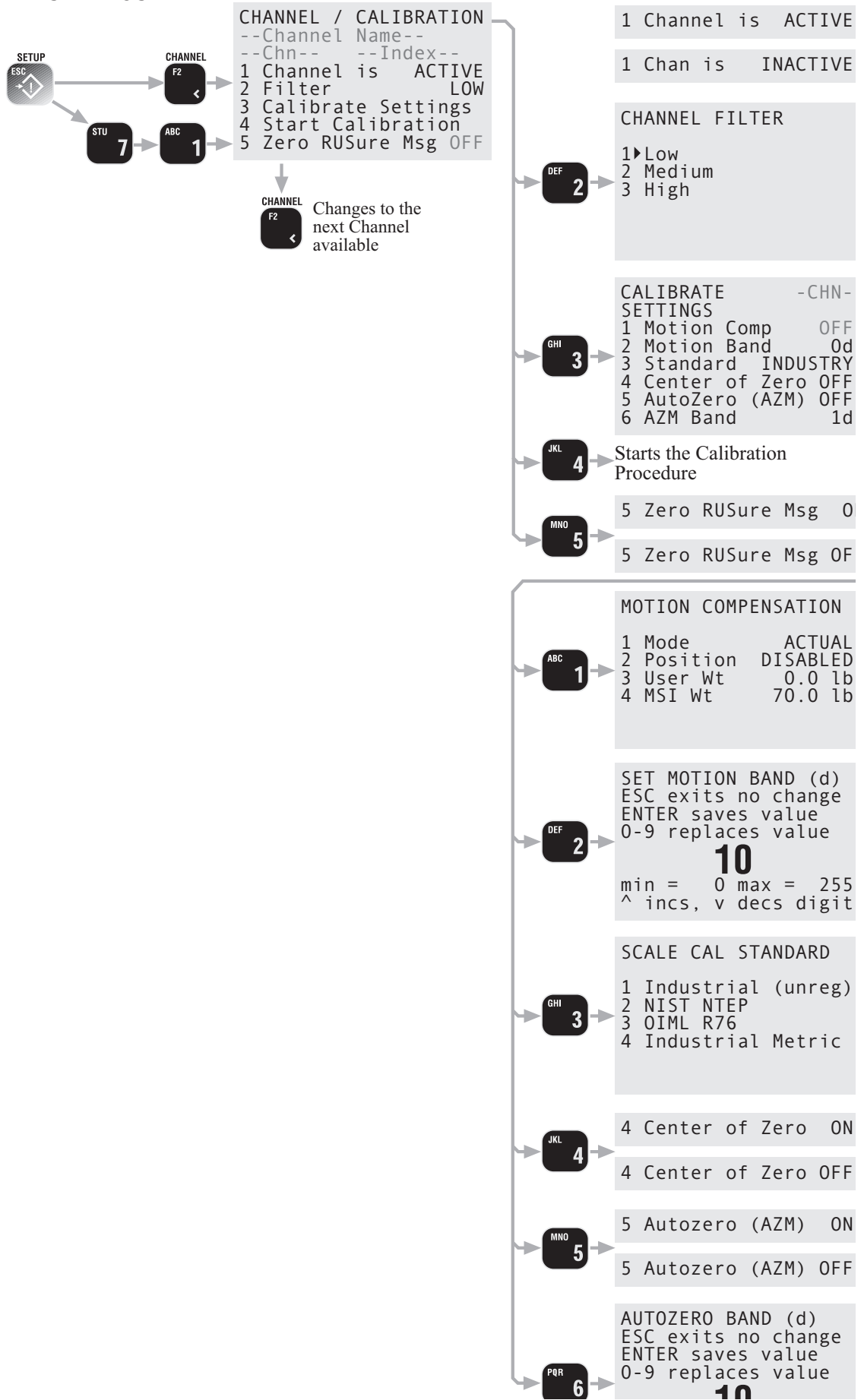



SYSTEM SETTINGS

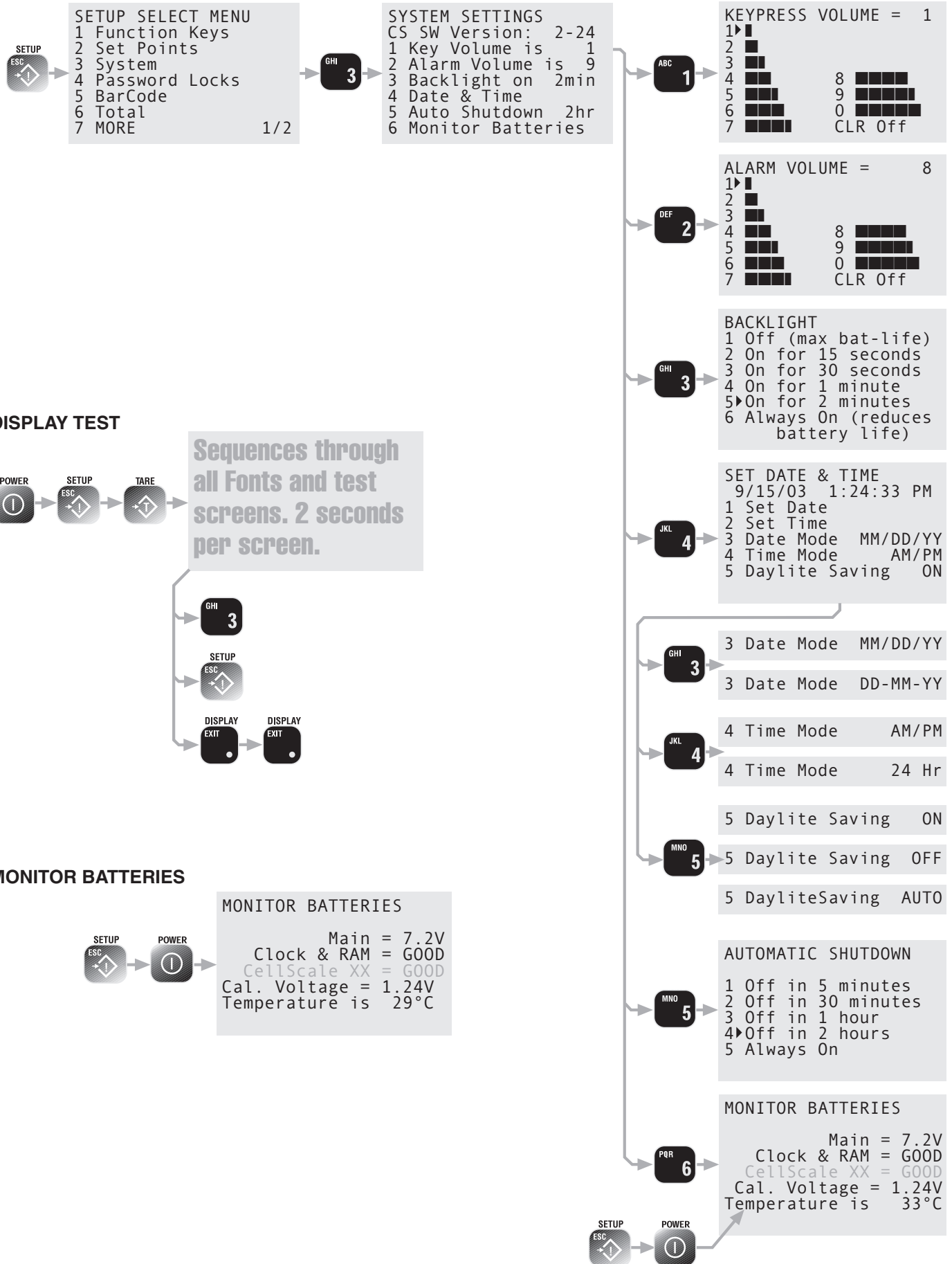

DISPLAY TEST

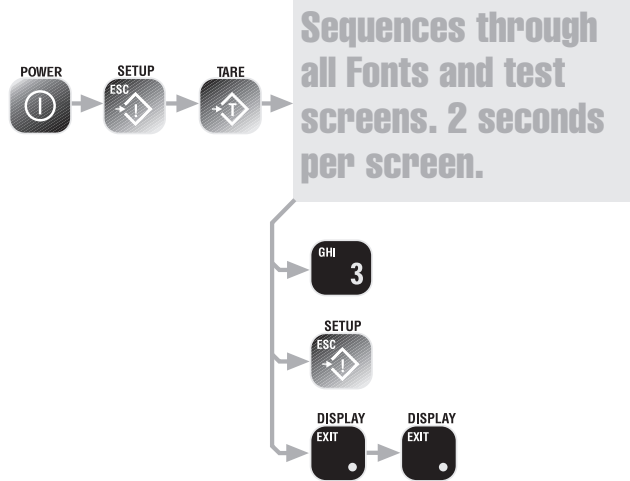

MONITOR BATTERIES

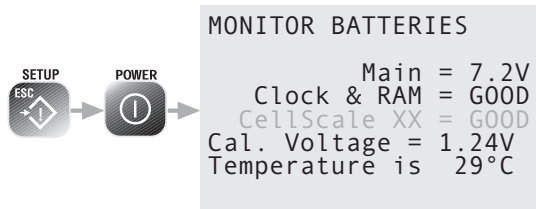

CALIBRATION

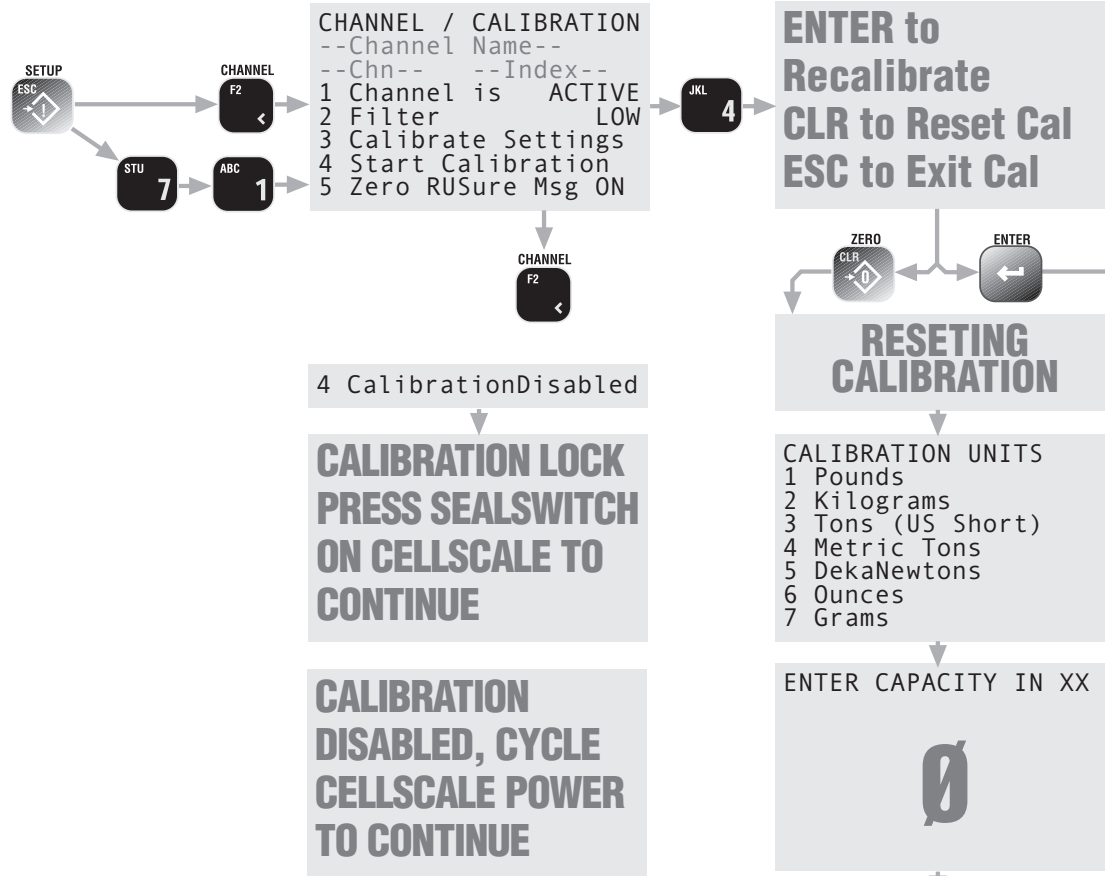

RESET ALL OR RESET RF MODEM

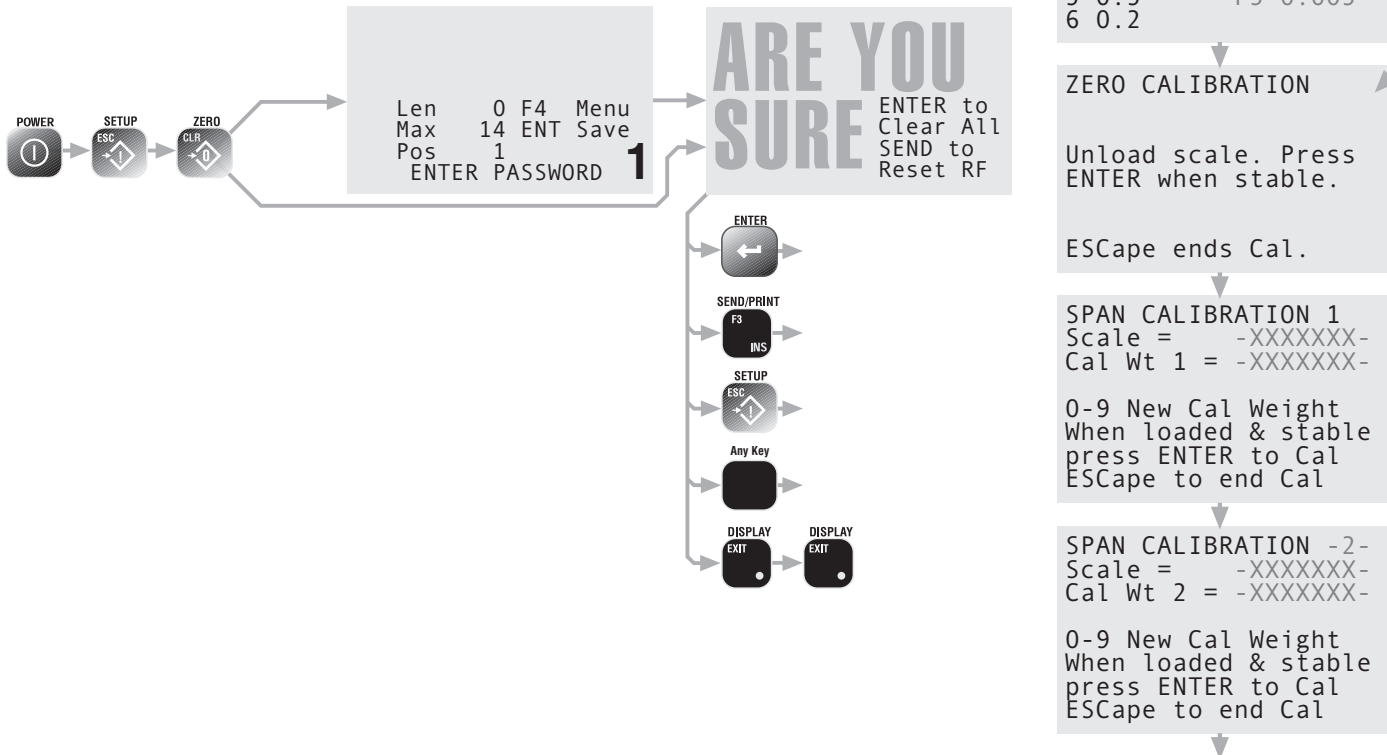



GENERAL TEXT ENTRY

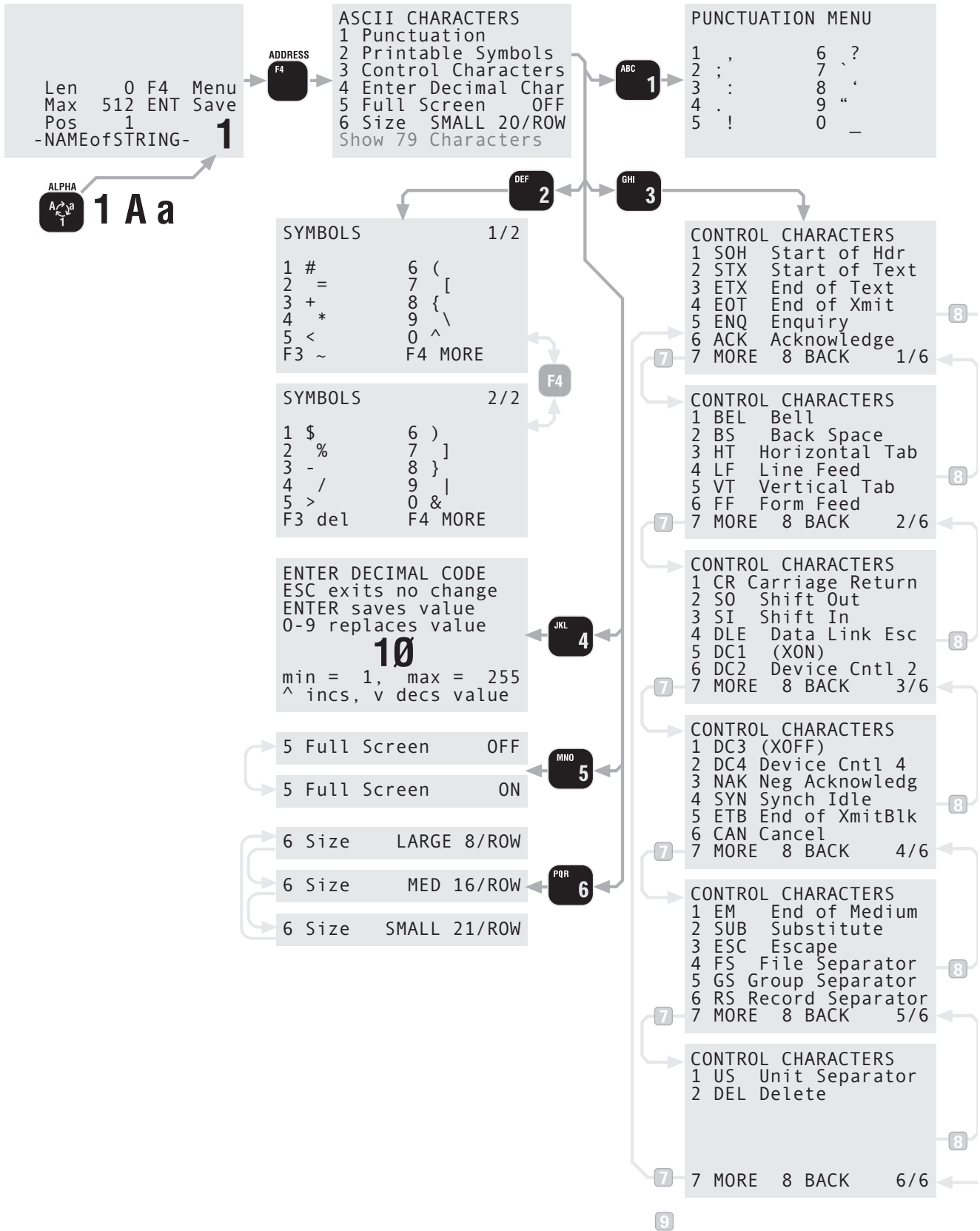

SET POINTS

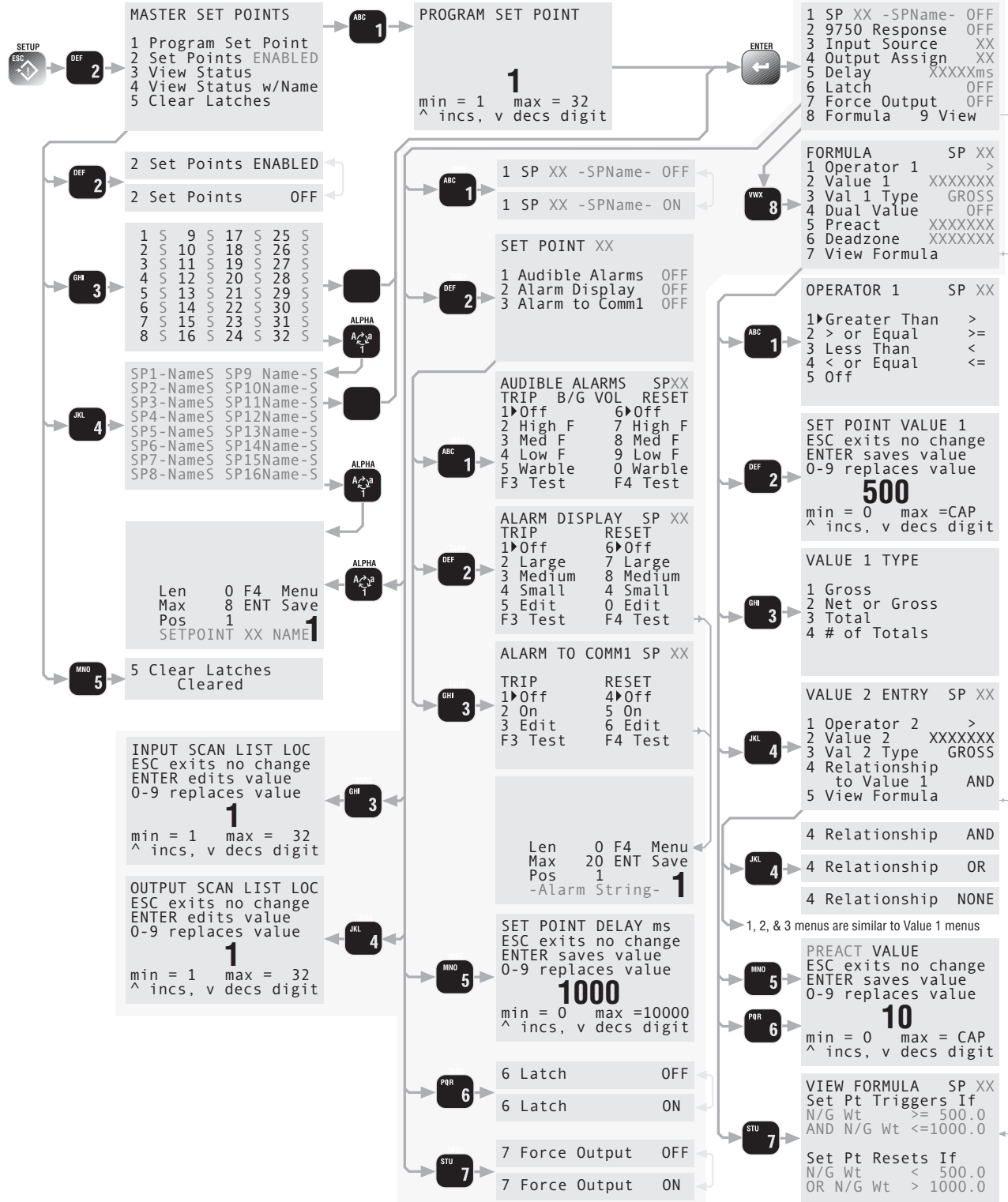



APPENDIX B – ASCII CHART

DEC	HEX	CHAR	DEC	HEX	CHAR	DEC	HEX	CHAR	DEC	HEX	CHAR
0	00	^@ NUL	32	20	SPC	64	40	@	96	60	`
1	01	^A SOH	33	21	!	65	41	A	97	61	a
2	02	^B STX	34	22	“	66	42	B	98	62	b
3	03	^C ETX	35	23	#	67	43	C	99	63	c
4	04	^D EOT	36	24	\$	68	44	D	100	64	d
5	05	^E ENQ	37	25	%	69	45	E	101	65	e
6	06	^F ACK	38	26	&	70	46	F	102	66	f
7	07	^G BEL	39	27	‘	71	47	G	103	67	g
8	08	^H BS	40	28	(72	48	H	104	68	h
9	09	^I HT	41	29)	73	49	I	105	69	i
10	0A	^J LF	42	2A	*	74	4A	J	106	6A	j
11	0B	^K VT	43	2B	+	75	4B	K	107	6B	k
12	0C	^L FF	44	2C	,	76	4C	L	108	6C	l
13	0D	^M CR	45	2D	-	77	4D	M	109	6D	m
14	0E	^N SO	46	2E	.	78	4E	N	110	6E	n
15	0F	^O SI	47	2F	/	79	4F	O	111	6F	o
16	10	^P DLE	48	30	0	80	50	P	112	70	p
17	11	^Q DC1	49	31	1	81	51	Q	113	71	q
18	12	^R DC2	50	32	2	82	52	R	114	72	r
19	13	^S DC3	51	33	3	83	53	S	115	73	s
20	14	^T DC4	52	34	4	84	54	T	116	74	t
21	15	^U NAK	53	35	5	85	55	U	117	75	u
22	16	^V SYN	54	36	6	86	56	V	118	76	v
23	17	^W ETB	55	37	7	87	57	W	119	77	w
24	18	^X CAN	56	38	8	88	58	X	120	78	x
25	19	^Y EM	57	39	9	89	59	Y	121	79	y
26	1A	^Z SUB	58	3A	:	90	5A	Z	122	7A	z
27	1B	^[ESC	59	3B	;	91	5B	[123	7B	{
28	1C	^\ FS	60	3C	<	92	5C	\	124	7C	
29	1D	^[GS	61	3D	=	93	5D]	125	7D	}
30	1E	^^ RS	62	3E	>	94	5E	^	126	7E	~
31	1F	^_ US	63	3F	?	95	5F	_	127	7F	DEL

APPENDIX C – SPECIFICATIONS & SUMMARY OF FEATURES

Temperature Range

- -20° C to +60° C Operating (-4° F to 140° F)
- -30° C to +80° C Storage (-22° F to 176° F)

Approvals (planned or pending)

NTEP, OIML, Factory Mutual, FCC

Radio Link

Frequency Hopping Spread Spectrum in 32 networks@ 2.4 GHz.
Radio functions in the ISM band, license free in the USA and Europe. 10mW (low power) or 100mW (high power) average output.

Radio Link Effective Range

Typically 500' (150 meters) indoors, 1000' (300m) outdoors with standard antennas. The 9750A range will increase if the CellScale is equipped with a long range antenna.

RFI/EMI Shielding

Exceeds NIST HB44 and CE Standards.

Housing

Reinforced PVC. 'O' ring gasketed. NEMA 3, IP54

Connectors

Power – 2.5 mm Coax, center pin positive.
Comm 1 – 9 Pin D (DE-9P)

Weight

2.2 lb. (1.0 kg)

STANDARD FEATURES

Scale Monitoring

Each 9750A can log on to 32 different networks allowing it to serve up to 32 separate CellScales. Easy 1 button scale changes. Each CellScale can access 32 independent Scale Channels. Supports display of up to 8 CellScale channels simultaneously.

Calibration

Via RF, the 9750A can calibrate any CellScale system. The system is sealed at the CellScale.

Keypad

24 keys – 6 user programmable (12 functions), 11 key alphanumeric, and 7 scale control keys

Push button Functions

Fixed keys:

Power: On/Off
Zero: Remove residual weight on scale
Net/Gross: Switch between Tared weight (Net) and Gross weight
Tare: Tare out empty container weight and switch to Net mode.
Alpha: Allows alpha character entry, upper and lower case
Enter: Store parameters or enter menus
Setup: Setup scale functions
0-9 with Alpha characters

PROGRAMMABLE FEATURES

- Automatic or Manual Tare entry
- 32 Set points with messaging capability
- Peak Hold – for capturing maximum readings
- 32 programmable ID Codes
- Each ID code has an 8 character name, two 20 character print strings, and stores independently units, tare, total with weighments counter, and full statistics.
- Selectable Automatic Power-Down, for battery power savings.
- Backlight On, Off or Automatic
- Lock –The user can lock any or all features to prevent tampering with setups. Protected by password.
- RS-232 I/O will output on demand, on a change, regular time interval, on a set point, on Total, by computer control or continuously.
- RS-232 I/O provides full output formatting to interface with computers, printers, scoreboards and most serial devices.
- Send / Print: Output user configured print strings to Comm Ports or via RF to any connected host.
- Manual or Automatic Data Logging. Up to 128 kbytes of storage (adequate for up to 6400 weight recordings)

Display

- 64 x 128 Full Graphics Module
- Multiple Font sizes, up to 8 lines of 20 characters
- Annunciators for measurement modes
- LED backlighting with timer for battery savings

Calibration Parameters

See CellScale specifications. All calibration data is stored in the CellScale, allowing any 9750A to use any CellScale based system without recalibration.

Real Time Clock

Supports date / time stamping in US or European formats. Backed up by a replaceable Lithium Battery (Typical life >5 years).

Data I/O

1 Comm Port, RS-232. Baud Rates: 300, 600, 1200, 2400, 4800, 9600, 14.4k, 19.2k, 28.8k, 38.4k, 57.6k, 76.8k, 115.2k, and 230.4k. Software and hardware handshaking.

ID

Up to 32 IDs can be stored in any connected CellScales and are identified by Alpha-numeric ID names. Each ID stores Totals, Statistics, Tare values, and two 20 byte string messages.

Totalizing & Statistics

Stored in connected CellScales, displayed on the 9750A. Total weight up to 999,999,999. Weighments counter up to 65,535. Totals and statistics are stored with each ID register. Each ID code keeps full statistics on totaled weighments. Included are Standard Deviation, Average, Minimum, Maximum, and Coefficient of Variance.

Data Logging

Two independent 64kByte battery backed memories for manual or automatic storage of weight data. Automatic storage based on time interval, set points, or loading conditions.

Audible Set Points or Totalize Indicator

Coupled with the internal Set Points, an alarm can sound at any weight. Can also be used for accept or an out-of-limits indicator for blind check-weighing. Can also be configured as a totalize alert.

Text Messaging

Able to receive and transmit user entered messages for display on the LCD. The 9750A replies with auto and manual replies to received messages. Audible alerts possible by including the ASCII "BEL" character.

Bar Code Interface

The 9750A can directly read industry standard Bar Code scanners and append the bar code data to weight, date, and time data generated by the CellScale. Pass thru data can be sent directly to host computers via MSI RF modems.

ACCESSORIES

AC Adapter / Battery Charger

90-260 Vac or 130-350 Vdc Option.

Vehicle Charge Adapter

Cigarette type charge adapter. 12-24VDC, fused at 5A

Bar Code Scanner

Several scanner types available. Contact MSI for specific application information.

THE MSI LIMITED WARRANTY

MEASUREMENT SYSTEMS INTERNATIONAL, INC., WARRANTS load sensing elements and meters against defects in workmanship and materials for a period of one year from date of purchase and warrants electrical cables and batteries against the same defects for a period of ninety (90) days from date of purchase.

Any device which proves defective during the warranty period will be replaced or repaired at no charge; provided that the defective device is returned to the Company freight pre-paid.

In no event shall the Company be liable for the cost of any repairs or alterations made by others except those repairs or alterations made with its specific written consent, nor shall the Company be liable for any damages or delays whether caused by defective workmanship, materials or otherwise.

The Company shall not be liable for any personal injury or property damage resulting from the handling, possession or use of the equipment by the customer.

The warranty set forth herein is exclusive and is expressly in lieu of all other warranties, express or implied, including without limitation any implied warranties of merchantability or fitness, or of any other obligations or liability on the part of the Company.

The liability of the Company under this warranty is limited solely to repairing or replacing its products during the warranty periods; and the final judgment and disposition of all claims will be made by MEASUREMENT SYSTEMS INTERNATIONAL, INC.

