

PC 150

Digital Bench Scale

Operation Manual

Revision 1.2
September 14, 2000

Transcell Technology inc.

© 1996-2000 Transcell Technology, Inc.

Contents subject to change without notice.

Transcell Technology, Inc.
975 Deerfield Parkway
Buffalo Grove, IL 60090
Tel (847) 419-9180
Fax (847) 419-1515
E-mail: transcell@transcell.net
Web: www.transcell.net

ATTENTION:

To extend the life of your digital scale, do not drop items to be weighed onto the platform or overload the scale beyond its rated capacity. Shock-loading and overloading may damage the load cell and void the warranty.

Table of Contents

Introduction	1
Installation and Wiring	2
Display Overview	3
Keyboard Functions	4
User Menu Mode	5
Setup Menu Mode	6
Calibration	8
APPENDIX A: Specifications	10
APPENDIX B: Troubleshooting the Serial Port	11
APPENDIX C: Displayed Error Codes	12
APPENDIX D: Warranty and Service Information	13

Introduction

The PC-150 Digital Bench Scale is a compact, 150 lb (70 kg) capacity bench scale with display and five function keyboard. It comes standard with a bright LED screen for easy readout, a removable stainless steel platform, and an RS-232C serial communication port.

The scale can be configured to display its divisions in two separate modes – non-NTEP mode and NTEP mode. The scale is shipped from the factory configured in non-NTEP mode. The NTEP mode is supplied for scales that need to comply with Hand-

book 44 requirements. To re-configure the scale, please refer to the “Setup Menu Mode” section of the manual.

The PC-150 uses full duplex RS-232C serial format for communication with personal computers or remote displays. The unit can transmit data on demand or continuously in several popular data protocols.

The scale’s serial communication parameters are altered through the User menu. The “User Menu Mode” section of the manual explains how to use the five front panel keys to maneuver and save settings in this menu.

Installation and Wiring

The PC-150 back panel comes equipped with a female DSUB-9 connector for the RS-232 serial port, a jack for DC power input, a calibration switch and an ON/OFF rocker switch. To install the scale, simply plug the enclosed AC Wall Adapter into the scale's DC power jack first, then into an AC outlet (115 VAC only). Finally, turn the rocker switch to the ON ("1") position. The scale is now ready for use.

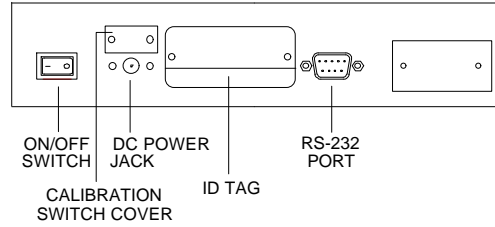

PC-150 Back Panel

The female 9-Pin RS-232 connector is used to interface to a PC. Shown at right are the pin assignments for the connector.

Pin No.	Pin Name
2	Receive Data
3	Transmit Data
5	Signal Ground

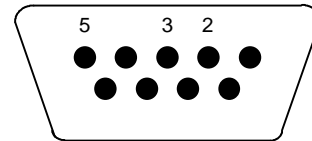

9-pin RS-232 connector (female)

Shown at right is the suggested cable diagram for direct connection to a PC. Or, you can order the optional pre-wired NMC-1 Null Modem Cable

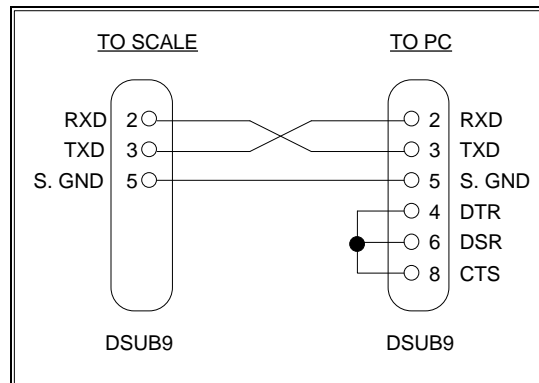

FIGURE 1. Cable Diagram for Scale to IBM PC

Display Overview





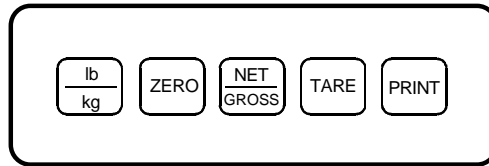

PC-150 Display Area

ANNUNCIATOR	MEANING
ZERO	Better known as the “Center of Zero” annunciator, this light is active whenever the displayed weight is within ± 0.25 divisions of true zero.
NET	Indicates that the scale is displaying net weight.
GROSS	Indicates that the scale is displaying gross weight.
TARE	Indicates that the tare weight in the system was established by means of the push button method.
lb and kg	Indicates the unit of the displayed weight.
STABLE	This light indicates that the scale is in equilibrium.

Keyboard Functions

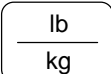

PC-150 Keyboard

KEY	FUNCTION
	Sets scale to display "0" only when a) in Gross mode, b) not in overload and c) not in motion.
	Toggles between Gross and Net weight display if a tare has been established.
	Used to establish the weight on the platform as the tare weight. You cannot establish zero or negative gross weight as a tare. Also, the scale must not be in motion or in overload.
	Toggles between lb and kg units if enabled in the User ("A") Menu.
	Sends "Print" data to serial port if scale is not in motion or in overload.

User Menu Mode

The PC-150 scale includes a User menu that contains the scale's serial communication parameters. It consists of 5 separate menu selections, each also with its own sub-menu of choices.

To change a listed parameter, you must first enter the User Menu mode. Once there, four of the front panel keys become directional navigators to move around in the menus, and one key is used to save or SET the selections.

To place the unit in User menu mode:

1. Turn the power off to the unit.
2. While holding down the **lb/kg** key, turn the power back on.
3. When the display shows "A1", the unit is in User Menu mode, and you can release the **lb/kg** key. Shown at right are the directional and SET key assignments

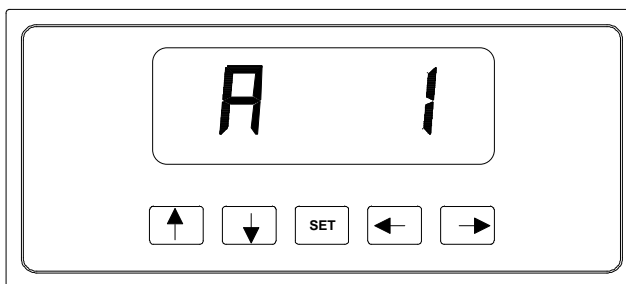

USER MENU CHART

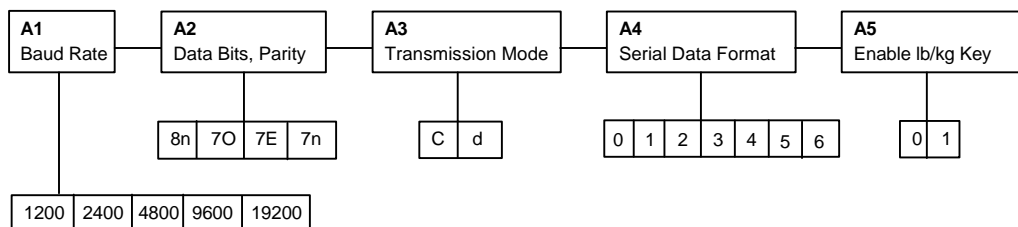

To place the unit back into the Normal Operating mode:

1. Turn off the scale. Turn the scale back on without pressing any keys.
2. The display will go through a digit check, then settle into Normal Operating mode. All front panel keys will now return to their normal mode of operation.

User Menu Mode / Continued

USER MENU DESCRIPTIONS

NAME/CODE	DESCRIPTION	CODE/VALUE
A1 Baud Rate	Selects the baud rate for data transmission through the serial port.	1200 2400 √ 4800 9600 19200
A2 Data Bits and Parity	Selects the number of data bits and parity of serial transmission. "8n" = 8 data bits with no parity bit and one stop bit "7O" = 7 data bits with odd parity bit and one stop bit "7E" = 7 data bits with even parity bit and one stop bit "7n" = 7 data bits with no parity bit and two stop bits	8n √ 7O 7E 7n
A3 Mode of Serial Transmission	Selects when data will be sent out of the serial port to a printer or computer: "C" = Continuous mode; send data continuously "d" = Demand mode; send data when a PRINT command is issued from the printer, computer, or scale.	C d √
A4 Serial Data Format	Selects the data format to be transmitted via the serial port to a printer or computer. "0" = Consolidated Controls Format "1" = Toledo 8213 Format "2" = NCI 3825Format "3" = Transcell Technology Format "4" = Detecto ASD Format "5" = Triner Format "6" = Fairbanks 70-2453-4 Format	0 1 2 3 √ 4 5 6
A5 Disable the lb/kg Key	Allows the lb/kg key to be disabled so that an operator cannot accidentally press the key and change the displayed units. "0" = Disable the lb/kg key "1" = Enable the lb/kg key	0 1 √

Setup Menu Mode

The PC-150 scale includes a Setup menu that determines the scale's display mode, allows scale calibration and also contains the scale's adjustable functional parameters. It consists of 5 separate menu selections, each also with its own sub-menu of choices.

To change a listed parameter, you must first enter the Setup Menu mode. Once there, four of the front panel keys become directional navigators to move around in the menus, and one key is used to save or SET the selections.

Setup Menu Mode / Continued

To place the unit in Setup menu mode:

1. Turn the power off to the unit.
2. Locate the calibration switch on the scale's back panel and toggle to the opposite position.
3. While holding down both the **ZERO** and **PRINT** keys, turn the power back on.
4. When the display shows "F1", the unit is in Setup Menu mode, and you can release the two keys. Shown at right are the directional and SET key assignments

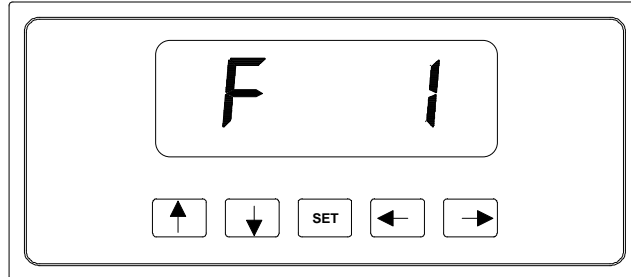

SETUP MENU CHART

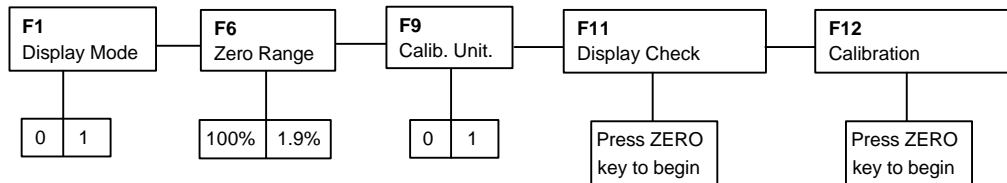

To place the unit back into the Normal Operating mode:

1. With the scale on or off, toggle the Calibration Switch back to its original position. Turn the scale back on without pressing any keys.
2. The display will go through a digit check, then settle into Normal Operating mode. All front panel keys will now return to their normal mode of operation.

Setup Menu Mode / Continued

SETUP MENU DESCRIPTIONS

NAME/CODE	DESCRIPTION	CODE/VALUE
F1 Display Mode	Selects display mode for the scale. "0" = Non-NTEP mode "1" = NTEP mode	0 √ 1
F6 Zero Range	Selects the range within which the scale may be zeroed. Note that the scale must be in standstill to zero the scale.	100% √ 1.9%
F9 Calib. Unit	Selects the primary base unit to be used in the calibration process. Also the default unit for normal operation. "0" = primary unit is lb. "1" = primary unit is in kg.	0 √ 1
F11 Display Check	Actuates the function that illuminates all digit segments, decimal points, and LCD annunciators in a test sequence. Pressing the ZERO key to scroll down one level begins the test sequence.	Press ZERO key to begin sequence
F12 Calibration	Places scale into the calibration routine. Scrolling down with the ZERO key one level begins the procedure.	Press ZERO key to begin sequence
F13 Factory Reset	This sub-menu will reset all parameters in the "F" and "A" menus to the default settings. USE WITH CAUTION!!!!	Press the ZERO key twice to execute.

NOTE: Sub-menu F13 restores all parameters in the User ("A") Menu and Setup ("F") Menu to the factory default settings. PLEASE USE CAREFULLY AS YOU MAY LOOSE VITAL SETUP PARAMETERS!!!

Calibration

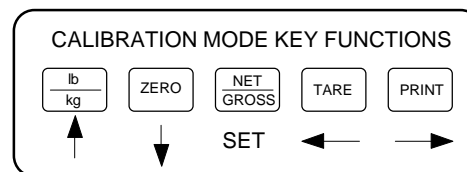
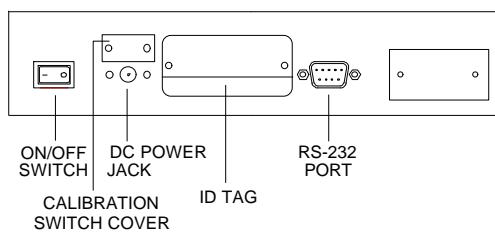

The scale can be calibrated by following the procedure below. The minimum test weight that can be used is 1.5 lb (0.7 kg), but 100 lb (50 kg) is the recommended test weight.

Calibration / Continued

To calibrate the scale:

1. If you are already in Setup Menu Mode, scroll to "**F 12**" and press the **ZERO** key. Otherwise, turn the scale off and set the Calibration Switch on the back panel to the opposite position. Turn the unit back on.

The message "**C 0**" appears on the display briefly, followed by a value which remains on the screen. Allow a 20 minute warm-up period for the load cell and electronics to become thermally stable.

2. Press **ZERO** to zero the value, then press the **NET/GROSS** key to save the zero point value.
3. The display will momentarily prompt "**C 1**" for the span calibration, followed by "**0.00**" with one digit flashing. Place the test weight on the platform.
4. Use the four directional keys to adjust the displayed value to the actual test weight value in pounds. Increase the flashing digit by pressing the **lb/kg** key. Decrease the flashing digit by pressing the **ZERO** key. The position of the flashing digit may be changed by pressing the **PRINT** key or the **TARE** key.
5. After setting the exact value, press the **NET/GROSS** key to save the value.
6. If the calibration was successful, the display will show "**ECAL**" momentarily, then freeze. Exit the Calibration mode and enter the Normal Operating Mode by positioning the Calibration Switch back to its original position.
7. If the calibration was *not* successful, one of the error messages below will appear. Take the indicated action to correct the problem, then perform a new calibration.

"**Err0**" - The calibration test weight or the adjusted keyed-in weight is larger than full scale. Change the calibration test weight or check the keyed-in weight.

"**Err1**" - The calibration test weight or the adjusted keyed-in weight is smaller than 1% of full scale. Change the calibration test weight or check the keyed-in weight.

"**Err2**" - Check keyed-in weight with the actual weight placed on platform.

To place the unit back into the Normal Operating mode:

1. Toggle the Calibration Switch back to its original position.
2. The display will go through a digit check, then settle into Normal Operating mode. All front panel keys will now return to their normal mode of operation.

APPENDIX A: Specifications

MODEL	Non Legal-for-trade Capacity	Legal-for-trade Capacity
PC-150	0 - 5 x 0.01 lb (0 - 2 x 0.005 kg) 5 - 70 x 0.02 lb (2 - 30 x 0.01 kg) 70 - 150 x 0.05 lb (30 - 70 x 0.02 kg)	0 - 150 x 0.05 lb (0 - 70 x 0.02 kg)

CONSTRUCTION:

Base: Steel and ABS

Platform: ABS

Feet: Non-skid Hard Rubber

DISPLAY:

6 Digit, 0.6", 7-Segment Green LED

OVER CAPACITY ANNUNCIATION:

102% of Full Scale Capacity

OPERATING TEMPERATURE RANGE:

32°F to 104°F
(0°C to 40°C)

PLATTER SIZE:

13" x 13" (330 mm x 330 mm)

POWER SOURCE:

AC Adapter, 12VDC, 500mA,
included

WEIGHT:

Net Weight: 24.3 lb (11 kg)

Shipping Weight: 27.8 lb (12.6 kg)

APPROVALS



Meets H-44 Class III
at 3,500 divisions

COC: 96-136A1



General Class III at
3,500 divisions

NOA: AM-5262

PHYSICAL DIMENSIONS

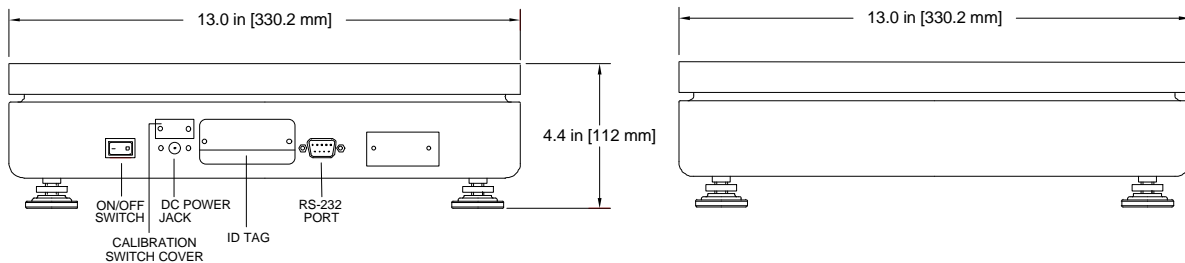

APPENDIX B: Troubleshooting the Serial Port

The scale's serial port operation can be verified by following the procedure below. This procedure makes use of HyperTerminal - a serial port communication program bundled with Windows 95 and Windows 98 operating systems. A HyperTerminal configuration file is available on the Transcell website.

A comprehensive summary of the various Serial Data Formats (SDF's) can be found in the PC-150 Service Manual.

To test the scale's serial port for proper operation:

1. Connect the NMC-1 Null Modem Cable or equivalent between the scale and your PC. Make sure to note which communication port (i.e. COM1, COM2) you are using on the PC.
2. On the scale, select the desired setting in the User Menu, including baud rate (A1), Data Bits and Parity (A2), mode (A3), and serial data format (A4). Note that all Transcell scales have a fixed parameter of one (1) stop bit.
3. On your PC, run HyperTerminal. Select the proper settings for the following using the scale's settings:
 - Baud Rate
 - Data Bits
 - Parity
 - Stop Bits = 1
4. Enable the CAPS LOCK key on your PC.
5. This test verifies that the scale is transmitting properly. If the scale is set to Demand mode, pressing the **PRINT** key on the scale should echo the weight readout on the PC screen. If the Continuous mode has been selected on the scale, the PC screen will overrun with weight information.

NOTE: The TOLEDO, NCI, FAIRBANKS and TRINER formats do not support a Continuous mode.

6. This test verifies that the scale is receiving properly. Use the table below to determine the valid commands for your serial data format setting. For example the 'P' command is executed by pressing the capital "P" key on your PC keyboard. Unless otherwise specified, you do not need to press the ENTER key on your PC.

NOTE1: If the scale is set to Continuous mode, the print commands will be ignored.

NOTE2: If the scale is in motion, the print commands will be ignored for most SDF's.

FUNCTION	FORMAT(S)	COMMAND
Print the weight	CONSOLIDATED & TRANSCCELL	'P'
	TOLEDO	'W'
	NCI & TRINER	'W' + <ENTER>
	DETECTO	'~'
	FAIRBANKS	<ENTER>

APPENDIX C: Displayed Error Codes

CODE	MODE	MEANING / POSSIBLE SOLUTION
□□□□□□	Normal Operating Mode	A weight greater than 102% of the scale's capacity has been applied to the scale. Remove the weight from the platter. Try re-calibrating the scale if this doesn't solve the problem. Otherwise, possible load cell damage due to overloading.
-----	Normal Operating Mode	Underrange condition. Platter has been removed. Re-install platter. Try re-calibrating the scale if this doesn't solve the problem. Otherwise, possible load cell damage due to shock loading.
- HI -	Warmup Mode	The scale has been turned on with a weight already present on the platter. Remove the weight and then press the ZERO key if necessary. Try re-calibrating the scale if this doesn't solve the problem. Otherwise, possible load cell damage due to overloading.
- LO -	Warmup Mode	The scale has been turned on without the platter installed. Install the platter and then press the ZERO key if necessary. Try re-calibrating the scale if this doesn't solve the problem. Otherwise, possible load cell damage due to shock loading.
Err 0	Calibration Mode	Keyed-in weight value in Calibration Mode is less than 1.5 lb (0.7 kg). Use a larger test weight or re-adjust value.
Err 1	Calibration Mode	Keyed-in weight value in Calibration Mode is larger than 150 lb (70 kg). Use a smaller test weight or re-adjust value.
Err 2	Calibration Mode	Internal resolution is not high enough to process keyed-in weight value in Calibration Mode. Verify test weight and value.
Err 3	All Modes	Diagnostics check error - EEPROM Read
Err 4	All Modes	Diagnostics check error - EEPROM Write

APPENDIX D: Warranty and Service Information

Transcell warrants that the PC-150 Digital Bench Scale will conform to written specifications, drawings, and other descriptions made by the manufacturer, including any modifications thereof. Transcell warrants the goods against faulty workmanship and defective materials. If any goods fail to conform to these warranties, Transcell will, as its sole and exclusive liability hereunder, repair or replace such goods if they are returned within the following warranty period:

Twelve (12) months from date of shipment from manufacturer.

These warranties are made upon the express condition that:

- 1) Transcell Technology, Inc. is given prompt written notice upon discovery by Buyer of such non-conformity, with a detailed explanation of the alleged deficiencies;
- 2) Such goods are returned to the Transcell at the expense of the Buyer;
- 3) Examination of such goods by Transcell discloses that the nonconformity actually exists and was not caused by accident, misuse, neglect, alteration, improper installation improper or unauthorized repair, or improper testing, and
- 4) Such goods have not been modified, altered, or changed by any person other than the Transcell or its duly authorized repair agents.
- 5) Transcell Technology, Inc. will have a reasonable time to repair or replace such goods.

THESE WARRANTIES EXCLUDE ALL OTHER WARRANTIES, EXPRESS OR IMPLIED, ORAL OR WRITTEN, INCLUDING WITHOUT LIMITATION WARRANTIES OF MERCHANTABILITY OR FITNESS FOR A PARTICULAR PURPOSE. TRANSCCELL WILL NOT IN ANY EVENT BE LIABLE FOR INCIDENTAL OR CONSEQUENTIAL DAMAGES.

IN ACCEPTING THIS WARRANTY, THE PURCHASER OR BUYER AGREES TO WAIVE ANY AND ALL OTHER CLAIMS FOR RIGHT TO WARRANTY FROM TRANSCCELL TECHNOLOGY, INC. SHOULD THE SELLER BE OTHER THAN TRANSCCELL TECHNOLOGY, INC., THE BUYER AGREES TO LOOK ONLY TO THE SELLER FOR WARRANTY CLAIM OR CLAIMS.

No terms, conditions, understanding, or agreements purporting to modify the terms of this warranty shall have any legal effect unless made in writing and signed by a corporate officer of the Transcell.