

# ***SURVIVOR<sup>®</sup> CW-80***

---

*Checkweigher*

## **Installation Manual**



**RICE LAKE WEIGHING SYSTEMS**

Industrial Solutions on a Global Scale<sup>®</sup>



32291

# Contents

<b>1. Introduction .....</b>	<b>1-1</b>
About the Manual .....	1-1
Overview .....	1-1
Features .....	1-2
Learning the Keypad and LED Displays .....	1-3
Keypad Functions and Related Displays .....	1-4
Front Panel Annunciator Lights .....	1-6
<b>2. Installation .....</b>	<b>2-1</b>
Unpacking and Assembly .....	2-1
Leveling .....	2-2
Making Power Connections .....	2-2
Load Cell Wiring .....	2-2
Wiring Standard Serial Communications Ports .....	2-3
Using Optional RS-485 Network Communications .....	2-4
Wiring the Optional Digital Outputs .....	2-6
Optional Battery Backup Operation .....	2-7
Board Diagrams .....	2-8
Power-Up Sequence .....	2-9
<b>3. Configuration .....</b>	<b>3-1</b>
Before You Begin .....	3-1
Moving Around in the Menus .....	3-2
SETUP Menu chart .....	3-4
Menu Descriptions .....	3-6
<b>4. Calibration .....</b>	<b>4-1</b>
Overview .....	4-1
Calibration Procedure .....	4-1
<b>5. Operating Modes .....</b>	<b>5-1</b>
Before You Begin .....	5-1
Overview of Operating Modes .....	5-2
TARGET Mode .....	5-3
OU PTT Mode .....	5-3
OU SET Mode .....	5-4
PTT/SET Mode .....	5-4
Displaying and Setting Over and Under Tolerance Values .....	5-5
Alternate Method for Changing Over or Under Values .....	5-7

Setting Tare Values .....	5-8
To Display the Current Tare Value .....	5-8
Using ID Storage Registers .....	5-12
Keyed ID Selection .....	5-12
Zeroing the Scale .....	5-14
Test Mode .....	5-14
<b>6. Using the EDP Port .....</b>	<b>6-1</b>
Overview .....	6-1
Simple Commands (No Response) .....	6-2
Inquiry Commands (Requesting Status/Data) .....	6-5
ID Reference Commands .....	6-15
Commands to Read and Write to IDs .....	6-20
<b>7. Advanced Features .....</b>	<b>7-1</b>
Bar Graph .....	7-1
Red Segments (2) .....	7-1
Green Segment (1) .....	7-2
Amber Segments (2) .....	7-2
Setting Bar Graph Segments .....	7-2
Print Formats .....	7-3
<b>8. Maintenance and Troubleshooting .....</b>	<b>8-1</b>
Display Error Codes .....	8-1
Troubleshooting Table .....	8-2
Main Board/Display Replacement .....	8-3
Removal .....	8-3
Installation .....	8-4
Load Cell Replacement .....	8-5
<b>9. Appendix .....</b>	<b>9-1</b>
Specifications .....	9-1
Assembly Drawings .....	9-4
Replacement Parts List .....	9-6
Indicator and Column Assemblies .....	9-6
10" x 10" Base Assembly .....	9-8
12" x 12" Base Assembly .....	9-8
18" x 18", 18" x 24", 24" x 24" Base Assemblies .....	9-10
ASCII Character Chart .....	9-12
Software Revision History .....	9-13
CW-80 Limited Warranty .....	9-14

# 1. Introduction

---

## In this section:

- About the Manual
- Overview
- Features
- Learning the keypad and LED Displays



## Warning

*Some procedures described in this manual require work inside the indicator enclosure. These procedures are to be performed by qualified field service personnel only.*



## Caution

*This unit uses double pole/neutral fusing which could create an electric shock hazard. Refer servicing to qualified field service personnel.*



## Note:

*Application specialists at Rice Lake Weighing Systems are available to help with unique situations not covered in this manual.*

## About the Manual

This manual is intended for use by qualified service technicians only. It is organized to efficiently provide information for installing and setting up the CW-80 Checkweigher for operation.

The Introduction section gives an overview of the CW-80 and its standard and optional features, explaining the keypad and LED functions.

Assembly and installation help are found in Section 2.

Section 3 explains how to move through the menus and make selections while in the Configuration mode. A set up menu page is followed by detailed descriptions of each set up parameter.

Calibration is covered in Section 4.

Section 5 details the various operational features. The CW-80 offers a choice of four different operating modes, including an all-new “target” mode. Read this section and consult with the end-user before configuring the operating mode of the CW-80.

Sections 6 and 7 cover advanced features like remote operation from an external keyboard and specialized print formats.

Maintenance, troubleshooting, and replacement parts information appears in sections 8 and 9.

When installation is complete, this manual should be retained by the installing scale technician. A separate *Supervisor’s Operating Guide* and *CW-80 Operator’s Card* are provided with the unit. They are designed to be left on-location to assist the scale operator.

## Overview

The CW-80 Checkweigher is a high-speed digital weight indicator and scale base programmed to compare weight readings with predetermined tolerance limits defining an ACCEPT band.

If the current weight reading is within the acceptable range, the green “ACCEPT” LED lights. If the current weight reading is less than the acceptable range, one or more of the red “UNDER” arrowheads light. If the current weight reading is greater than the acceptable range, one or more of the amber “OVER” arrowheads light.

In addition to illuminating the appropriate LED’s, the CW-80 can signal the current Over/Under/Accept status as setpoints by using TTL compatible digital outputs. A serial port can be used to send out check-weight results to an external controller or data collector.

300 Over/Under/Tare/Units register sets can be linked to ID’s for easy recall of stored values. These registers can be modified by serial commands from a computer, or by using the keys on the front panel.

## Features

The CW-80 offers a variety of standard and optional features that are shown below in Table 1-1 and 1-2.

**Table 1-1. Standard Features**

All standard models include...
<ul style="list-style-type: none"> <li>• Choice of operating voltage and battery backup:               <ul style="list-style-type: none"> <li>• 115 VAC operation</li> <li>• 230 VAC operation</li> <li>• 115 VAC operation with 6 VDC battery backup</li> <li>• 230 VAC operation with 6 VDC battery backup</li> </ul> </li> <li>• Large .8-inch, 7-segment, 6-digit LED display</li> <li>• 8-key membrane touch-panel (keypad) with keys for Over, Under, Tare, Zero, Units, Print, Target, and ID</li> <li>• Annunciator lights for unit selection</li> <li>• High-intensity LED indicators for Over, Under, and Accept</li> <li>• Display units in decimal lb, kg, oz, lb and oz, grams</li> <li>• Stainless steel load cell for capacities of up to 60 lb</li> <li>• Aluminum load cell for capacities of 100 lb and over</li> <li>• Front panel calibration with internal memory to store calibration constants</li> <li>• Storage for up to 300 tare and tolerance ID settings</li> <li>• Automatic zero-tracking</li> <li>• Bidirectional RS-232 or simplex 20 mA current loop communications</li> <li>• NEMA 4X/IP66 indicator enclosure</li> </ul>

**Note:**

*Some setup parameters may relate to optional features that may not be installed on your CW-80. Changing the parameters for an uninstalled option has no effect.*

**Table 1-2. Optional Features**

Optional features include...
<p><i>Electronics:</i></p> <ul style="list-style-type: none"> <li>• 6 VDC replacement battery pack</li> </ul> <p><i>Outputs:</i></p> <ul style="list-style-type: none"> <li>• 3 TTL active low outputs</li> <li>• 3 normally-open relays</li> <li>• 3 normally-closed relay outputs</li> </ul> <p><i>Software:</i></p> <ul style="list-style-type: none"> <li>• RS-485 communications, 2-wire, half-duplex format</li> </ul> <p><i>Hardware:</i></p> <ul style="list-style-type: none"> <li>• 24-inch indicator column</li> <li>• 30-inch indicator column</li> <li>• 10-inch x 10-inch cutting board</li> <li>• 12-inch x 12-inch cutting board</li> <li>• Combination desk/wall mount bracket</li> <li>• 304 stainless steel clamshell load cell protection for capacities of 100 lb and over</li> </ul>

**Note:**

*Application specialists at Rice Lake Weighing Systems are available to help with unique situations not covered in this manual.*

## Learning the Keypad and LED Displays

The front panel consists of a 6-digit LED alphanumeric display, individual status indicators, annunciator LED's, and a membrane touch-panel (keypad) encased in a watertight stainless steel case.

Take some time to familiarize yourself with the CW-80 front panel shown below and the key functions described on the following pages. Table 1-3 provides you with detailed descriptions of all keys and related displays. Table 1-4 provides information about front panel annunciator LEDs.

**Figure 1-1.**  
CW-80 front panel



## Keypad Functions and Related Displays

Table 1-3 describes CW-80 front panel keys and related display functions.

**Table 1-3. Front Panel Keys**



<b>ZERO key</b>
<p>The <b>ZERO</b> key sets the current Gross weight to Zero, provided the amount of weight to be removed or added is within the specified Zero Range and scale is not in motion. The Zero Band can be either 100% or 2% of full scale capacity. This key has secondary functions when using ID storage and when setting TARE/OVER/UNDER values.</p>
<b>UNITS key</b>
<p>The <b>UNITS</b> key switches the weight display to an alternate unit. The alternate unit is defined in the Setup menu, and could be kg, g, lb, oz, or lb and oz. Conversions of the weight reading, the Tare value, the Over value and the Under value occur when the unit of measure is changed with the <b>UNITS</b> key. This key has secondary functions when using ID storage and when setting TARE/OVER/UNDER values.</p>
<b>PRINT key</b>
<p>When enabled, the <b>PRINT</b> key sends “on-demand” serial information out the serial port provided the conditions for standstill are met. The Print Out parameter defines the format for printed information. This key has secondary functions when using ID storage and when setting TARE/OVER/UNDER values.</p>
<b>TARE key</b>
<p>The <b>TARE</b> key performs one of several predetermined Tare functions dependent on the mode of operation selected. Setup options include the following list below. (See TARE description in section 3 for more information). This key has secondary functions when using ID storage and when setting TARE/OVER/UNDER values.</p> <p><b>In SET Mode</b> Allows direct tare value entry via front keypad, incrementing or decrementing as directed until the desired Tare value is displayed. The last Tare value displayed is stored after 3 seconds of inactivity.</p> <p><b>In PTT (push to tare) Mode</b> Acquires Tare value by pressing <b>TARE</b> key. Positive gross weight on platter at the time <b>TARE</b> key is pressed is acquired. The display shifts to the Net mode, NET LED is illuminated, and a NET weight of 0 in the current unit of measure is displayed. Pressing the TARE key at Gross Zero removes the tare from the system in this mode.</p> <p><b>DIS (disabled)</b> Disables the Tare function. The NET weight display mode is disabled. Entry of Tare values is <i>not</i> permitted. Weighing is by gross weight only.</p>



**Note:**

See the Over bar graph LEDs on the front panel (Figure 1-1).



**Note:**

See the Under bar graph LEDs on the front panel (Figure 1-1).



**Note:**

See the Accept bar graph LED on the front panel (Figure 1-1).



**Table 1-3. (continued)**

<b>OVER key/UP ARROW key</b>	
<b>OVER key</b>	The <b>OVER</b> key allows the display of the current “Over tolerance” value, or allows setting the Over tolerance” value. See “Displaying/Setting Over/Under/Tare Values”. As a secondary function, the <b>OVER</b> key also acts as an <b>Up Arrow</b> key while in the Configuration mode.
<b>UP ARROW key</b>	When in the SET mode, or when selecting an ID number, pressing this key establishes an upward direction for modifying the value. When in the Configuration mode, the <b>Up Arrow</b> key moves “up” one level in the Configuration menu tree, locking in the value displayed.
<b>UNDER key/DOWN ARROW key</b>	
<b>UNDER key</b>	The <b>UNDER</b> key allows the display of the current “Under tolerance” value, or allows setting the current “Under tolerance” value. As a secondary function, the <b>UNDER</b> key will also act as an <b>Down Arrow</b> key while in the Configuration mode.
<b>DOWN ARROW key</b>	When in the SET mode, or when selecting an ID number, pressing this key establishes a downward direction for modifying the value. When in the Configuration mode, the <b>Down Arrow</b> key moves “down” one level in the Configuration menu tree, allowing you to view a current parameter setting.
<b>TARGET key</b>	
	When the CW-80 is set up in Target mode, the <b>TARGET</b> key is used to acquire a weight value from the platter, and assign it as the desired “Target” value. The CW-80 then computes the Under and Over values based on predetermined tolerance settings defined during configuration.
<b>LEFT ARROW key</b>	As a secondary function, the <b>TARGET</b> key also acts as a Left Arrow key when navigating through the Configuration menu tree. When used in the Configuration mode, the <b>TARGET</b> key moves “to the left” one position within the Configuration menu tree, allowing you to view other parameter choices on the same level.
<b>ID key</b>	
	The <b>ID</b> key is used to select a particular Over/Under/Tare/Units register set to be retrieved, altered, saved, used, etc.
<b>RIGHT ARROW key</b>	As a secondary function, the <b>ID</b> key also acts as Right Arrow key when navigating through the Configuration menu tree. When used in the Configuration mode, the <b>ID</b> key moves “to the right” one position within the Configuration menu tree, allowing you to view other parameter choices on the same level.



## Front Panel Annunciator Lights

Table 1-4 describes the functions of the front panel annunciator LEDs.

**Table 1-4. Front Annunciator LEDs**

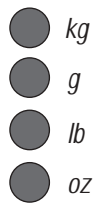
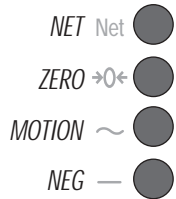

<b>NET, ZERO, MOTION, NEG</b>	
<p><b>NET LED</b> When illuminated, this LED indicates that the displayed weight is the NET Weight, or that the CW-80 is in the NET weight display mode, and that a Tare value is being applied to the current Gross weight reading.</p> <p><b>ZERO (Center of Zero) LED</b> When illuminated, while in the Gross weight display mode, this LED indicates that the current displayed weight reading is within +/- 0.25 display division (dd) of the acquired Zero, or is within the Center of Zero Band. When in the Net weight display mode, it indicates that the current Net weight reading is within +/- 0.25 dd of the Center of Net Zero. A display division (dd) is the resolution of the displayed weight value, or the smallest incremental increase or decrease that can be displayed or printed.</p> <p><b>MOTION LED</b> When illuminated, this LED indicates that the scale's weight reading is unsettled, or unstable. For the MOTION LED to remain in the OFF state, scale motion must not have occurred within the last second. A scale is "In Motion" when the current weight reading varies from the previous weight reading by more than the value of the Motion Band (STABLE).</p> <p><b>NEG (Minus) LED</b> When illuminated, this LED indicates that the six displayed digits represent a negative value when UNITS is set to "lb/oz" mode. It allows the full 6-digit display to be used for weight display, eliminating the need to display the minus sign. Normally, a minus sign is displayed on the 6-digit display.</p>	<p><b>kg, g, lb, oz</b></p> <p><b>lb LED</b> When illuminated, this LED indicates the unit of measure is pounds (lb). This setting affects the serial data output unit of measure.</p> <p><b>kg LED</b> When illuminated, this LED indicates the unit of measure is "kilograms" (kg). This setting affects the serial data output unit of measure.</p> <p><b>oz LED</b> When illuminated, this LED indicates the unit of measure is "ounces" (oz). This setting affects the serial data output unit of measure.</p> <p><b>g LED</b> When illuminated, this LED indicates the unit of measure is "grams" (g). This setting affects the serial data output unit of measure.</p> <p><b>lb/oz LED</b> When both the "lb" and "oz" LEDs are illuminated, these LEDs indicate that the unit of measure is pounds and ounces (lb oz). This setting affects the serial data output unit of measure as well as the display.</p>

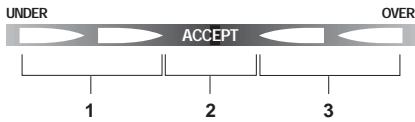

Bar Graph Segment Key
1 .. Red Segments
2 .. Green Segment
3 .. Amber Segments

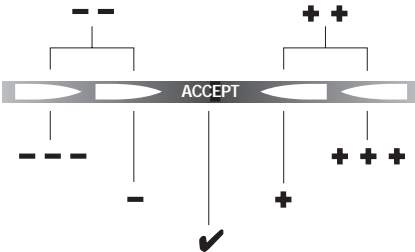

Bar Graph LED Key
--- .... greatly under when this one is lit
-- ..... moderately under when both are lit
- ..... slightly under when this one is lit
✓..... (target) acceptable weight when lit
+ ..... slightly over when this one is lit
++ ..... moderately over when both are lit
+++ .. greatly over when this one is lit

**Table 1-4. (continued)**

**Bar Graph LEDs: Red, Green, and Amber**

The Bar Graph LEDs provide you with a fast way of determining if a container is too heavy (Over), too light (Under), or is within an acceptable weight range (ACCEPT). It consists of 5 LEDs (or segments):

**Red Segments (2 of these)**

Indicates an underweight condition. When lit, the red segment(s) indicates that the container weighs less than the *lowest* acceptable value. There are three levels of Under weight readings. The leftmost red segment is used to indicate that the container weight is far below the acceptable weight band (greatly under); the rightmost red segment is used to indicate that the container weight is almost in the acceptable weight band, but still under (slightly under). Illuminating both red segments indicates “middle ground”, or moderately under.

**Green Segment (1 of these)**

Indicates an Accept value. When lit, the green segment light indicates that the container weight is within the actual *acceptable* band of weight limits.

**Amber Segments (2 of these)**

Indicates an overweight value. When lit, the amber segment(s) indicate that the container weight is more than the *highest* acceptable weight value. There are three levels of Over weight readings. The leftmost amber segment is used to indicate that the container weight is almost in the acceptable weight band, but still over (slightly over ); the rightmost amber segment is used to indicate that the container weight is far above the acceptable weight band (greatly over). Illuminating both amber segments indicates a “middle ground”, or moderately over.

See Section 7, *Advanced Features*, for more information about the Bar Graph feature.

## 2. Installation

### In this section:

- Unpacking and Assembly
- Leveling
- Making Power Connections
- Load Cell Wiring
- Wiring Standard Serial Port
- Optional RS-485 Network Communications
- Wiring Optional Digital Outputs
- Optional Backup Battery Operation
- Board Diagrams
- Power-Up Sequence

### ⚠ Caution

Do not pick up the scale by the “spider” assembly which supports the platter. Lifting by the spider may damage the load cell. Lift the scale from under the base to move it.

### ⚠ Caution

If rear panel is removed, align rear panel gasket holes carefully to prevent driving a screw through the gasket and causing a leak. Tighten screws to 15 in/lbs in alternating pattern shown below.

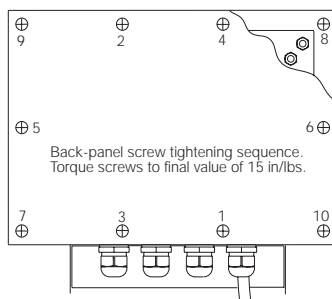

### Unpacking and Assembly

1. When opening the shipping carton, notice that the indicator head and support column or stand are shipped detached from the scale platform.
2. Remove all assemblies from the shipping carton. *Notice that the head and scale platform are joined by a load cell cable. This cable is correctly wired to the load cell terminal in the indicator head. Do not to pull with excessive force on the connections at either end of this cable.*
3. If mounting the head onto a column, remove the platter from the scale platform and set aside.
4. Invert the platform so you have access to the column mounting bolts on the rear and bottom of the platform. Remove the four bolts.
5. Position the column over the platform mounting holes. Install the four bolts and tighten them snugly. Install the two feet provided in the hardware kit onto the column.
6. Turn the CW-80 Checkweigher upright and replace the platter on the platform.
7. Attach the head to the column with the two bolts provided in the hardware kit.

If mounting the indicator head to the table/wall stand, simply attach the head with the two bolts provided in the hardware kit.

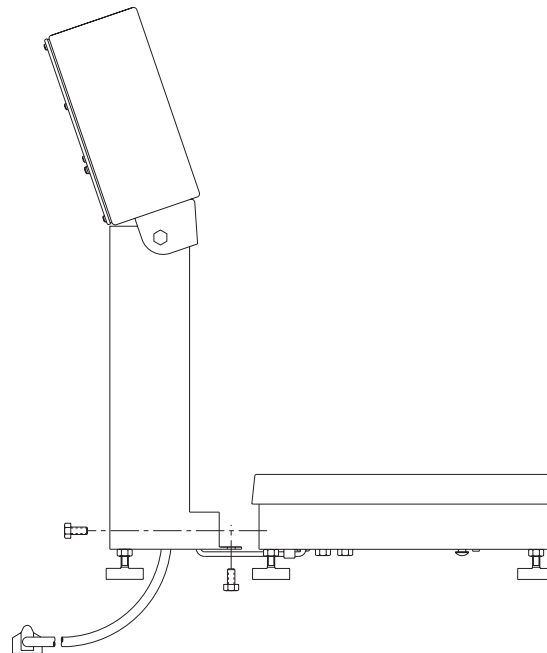

Figure 2-1 Mounting column to scale platform

## Leveling

Select a location for the CW-80 that is reasonably level and free of unnecessary vibrations and air currents.

Adjust the four corner feet on the base until the bubble level on the inside frame of the unit reads level. When level, the base should not rock and all four feet should have solid contact with the support surface. If using a column with your scale, adjust the two column feet until they make solid contact with the support surface.



Static electricity may cause loss of stored information if the Checkweigher chassis is not properly grounded.

## Making Power Connections

The power source used for AC models of the CW-80 must be properly grounded to an acceptable earth ground. When the indicator head is remotely mounted, the platform must be separately grounded from the chassis ground screw located on the bottom of the platform. Connect this screw with 18 gauge wire to the same earth ground system as the AC power source. Failure to ground the base may cause static buildup and incorrect weights.

**Note:** Because the CW-80 has no power on/off switch, the supply cord serves as the power disconnect. The power outlet used must be located close enough to the CW-80 so the operator can easily unplug the unit from power.

## Load Cell Wiring

On all units, the load cell has been wired to the indicator's CPU load cell terminal at the factory. On units supplied with a column, extra load cell cable is coiled inside the indicator head.

If a base and indicator head for remote mounting have been ordered, coil the extra load cell cable inside the head after installation is complete.

**Figure 2-2**  
**Load Cell**  
**Terminal**

**Note:**

Stainless steel load cells in scales with capacities from 6-60 lbs use the following wiring code:

Green	+EXC
Black	-EXC
Red	-SIG
White	+SIG
Yellow	SHLD

Aluminum load cells in scales with capacities from 100-1000 lb use the following wiring code:

Green	+EXC
Black	-EXC
Red	+SIG
White	-SIG
Blue	+SENSE
Brown	-SENSE
bare	SHLD

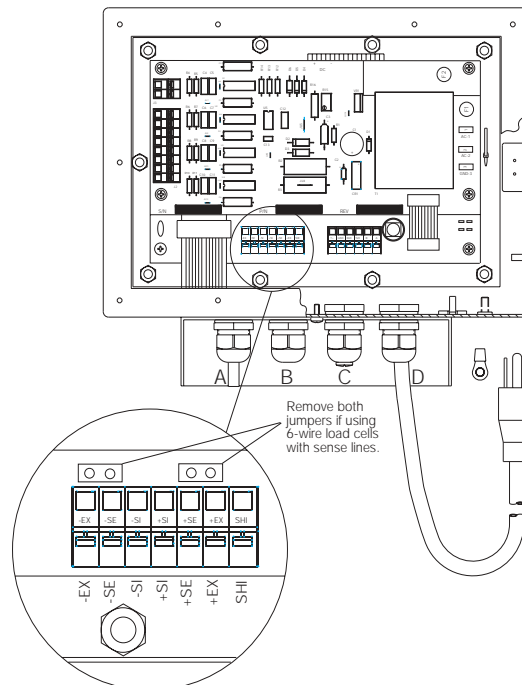

You can access all terminal blocks on the CPU Board and Power Board by removing the rear cover of the indicator case. The cover is held on by 10 screws.

If using 6-wire load cell cabling, remove the two jumpers above the load cell terminal strip.

## Wiring Standard Serial Communications Ports

**Note:**

The four cord grips on the bottom of the indicator head should be used for the cables listed below. Refer to Figure 2-3.

A — Backup Battery Cable

B — Load Cell Cable

C — Serial Communications Cable

D — AC Power Cable

Serial communications for the CW-80 is provided through a serial communications terminal block located on the CPU board next to the load cell terminal block. (See Figure 2-3).

This terminal block provides a port for both EDP (Electronic Data Processing) devices and printers or remote displays. You must configure this port for your specific application (see Section 3, *Configuration*, for more information). The CW-80 communicates with bidirectional RS-232C and/or output-only 20 mA Current Loop interfaces. For network applications with up to 32 devices, 2-wire, half duplex RS-485 is available as an option.

See Table 2-1 for serial terminal block wiring configurations.

**Table 2-1.**

Serial Communications Port			
Pin	EDP (RS-232) Bidirectional	EDP (20 mA) Out Only	Network (RS-485)* Half Duplex Bidirectional
T+	—	T+	—
GND	GND	GND	GND
RXD	RXD	—	—
TXD	TXD	—	—
B	—	—	485B
A	—	—	485A

\* Optional feature: See Section 7, *Advanced Features*, for more information.

**Figure 2-3.**  
Serial communication terminal

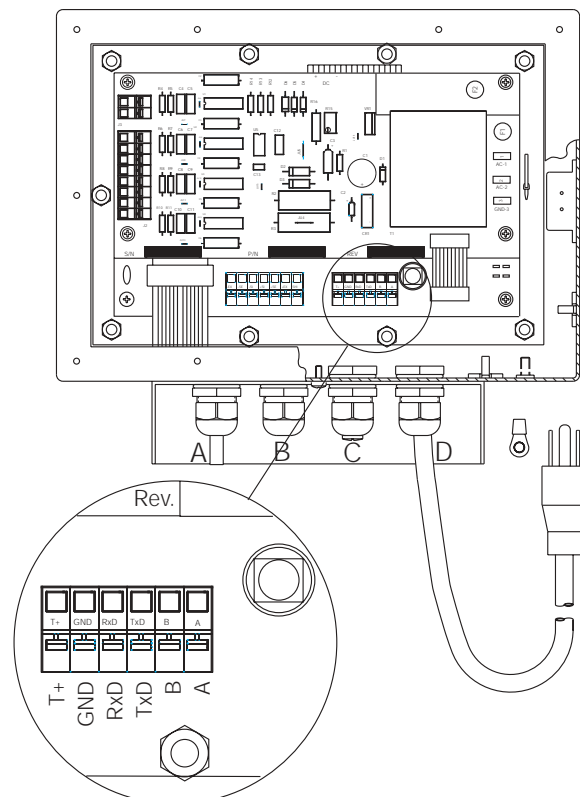

The following communications parameters (Table 2-2) apply to both the RS-232 and 20mA Current Loop interfaces.

**Table 2-2.**

Serial communications parameters
<ul style="list-style-type: none"> <li>• Continuous or Demand outputs</li> <li>• 150, 300, 600, 1200, 2400, 4800, 9600, or 19200 baud rate</li> <li>• 7 data bits (with parity) or 8 data bits (no parity); 1 start bit and 1 stop bit</li> <li>• None, odd, or even parity</li> <li>• Line termination: &lt;CR LF&gt; or &lt;CR&gt;</li> <li>• End of line delay up to 2.0 seconds in 200 mS increments</li> </ul>

## Using Optional RS-485 Network Communications

**Note:**

*RS-485 must be purchased at time of order and factory installed. No field installation of this option is available.*

You can configure multiple CW-80 Checkweigher to operate on a 2-wire RS-485 network serial communications line. The expanded serial communication option allows network applications.

To enable RS-485 communications, you must connect two communication wires to terminals A and B on the serial communications terminal. A ground wire is also required. See Figure 2-3 and Table 2-1 on the previous page for more information on expanded serial communications.

Consider the following guidelines for an RS-485 interface.

**Table 2-3.**

RS-485 hardware
<ul style="list-style-type: none"> <li>• Every piece of equipment must have a unique address.</li> <li>• Every piece of equipment must remain quiet while waiting for a command.</li> <li>• All interface wiring and RS-485 transceivers must be correctly installed as 2-wire implementations.</li> <li>• The ground terminals of all equipment in the network must be connected to minimize common mode voltage differences.</li> </ul>

**Table 2-4.**

RS-485 software
<ul style="list-style-type: none"> <li>• The controller software must be compatible with the CW-80's protocol. Some equipment may have its own, proprietary RS-485 protocol.</li> <li>• All equipment in the RS-485 network must follow the rules of half duplex communications: "Be quiet unless spoken to" and "Never echo back what you are receiving."</li> <li>• The controller must turn on its transmitter, send the commands, wait for the transmission, and finally, turn off its transmitter to listen.</li> <li>• The controller software must be able to handle the echo from its own transmission, since the transmit and receive lines are shared.</li> </ul>

You enable the optional RS-485 software protocol for the CW-80 by assigning an address to the EDP port in the Serial menu. The address assigned must be a 2-digit integer between 00 and 99.

Since the RS-485 protocol requires that each device has a unique address, all remote commands sent to a checkweigher must be initiated as shown below:

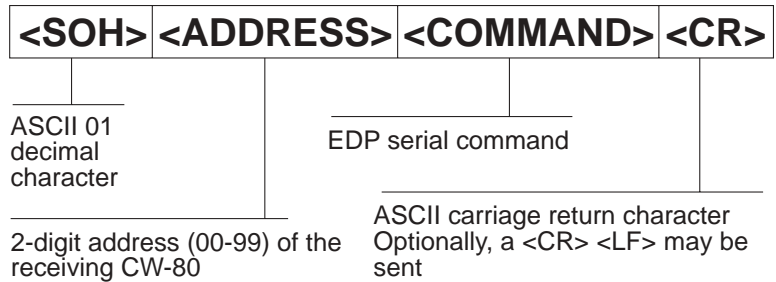

If the address of the incoming command matches the port address of a CW-80 listening on the RS-485 network, that CW-80 responds.

For demand outputs, the protocol is as shown below:

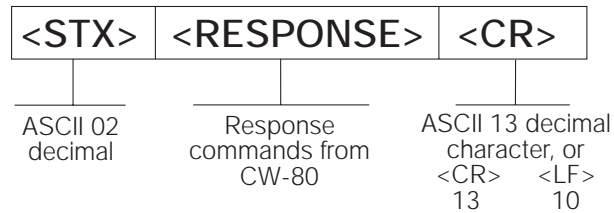

For example, suppose you wish to send a remote command from an ASCII terminal to call up the current target value of ID# 005 of a particular CW-80 on the RS-485 network. After checking the appropriate command reference table, you determine that **XTG** is the correct command to use. Assume the CW-80's address is 65.

After consulting an ASCII chart, you determine that the keyboard equivalent for the SOH character (02) is **CONTROL-A**, and the CR character is **ENTER**. Therefore, from the terminal you press:

**<CONTROL-A>,6,5,X,T,G,0,0,5,ENTER.**

The CW-80 responds with:

**<STX>G005 2.50KG<EOL>**

If the CW-80 is configured for continuous outputs, the protocol will be dependent upon the print format selected. See Section 7-3 through 7-6 for more information on selecting print formats.

## Wiring the Optional Digital Outputs

### NOTE:

Unless one of the Output Options (B–G) has been ordered, no terminal block (J2) or other relay components are included on the CW-80 board for wiring digital outputs.

Wiring for optional relays uses the same J2 terminal block as the TTL digital output option. Additionally, if a relay option has been ordered (Options C, D, F, or G) selected wire traces have been cut at the factory to enable relay use.

Note that because each relay has its own separate set of dry contacts, it is possible to have both AC and DC relays on the same terminal block.

### TTL Output Options

Wire selected digital outputs for Over, Accept, and Under to connector J2 on the power supply board (Figure 2-4). There is capacity for up to 3 TTL outputs. Table 2-5 provides J2 pin numbers and corresponding digital connections.

Each output is an open-collector circuit, capable of sinking 250 mA when “on” and withstanding +40 VDC when “off.” All logic levels are active-low. The circuits include +5 V pull-up resistors to drive TTL or 5 V CMOS logic without additional hardware.

### Relay Output Options

If equipment is to be driven that requires more than 5 V TTL levels, optional plug-in relays are available for relays sockets on the CW-80 power supply board. These on-board relays are necessarily small—rated for a maximum 0.5 Amp, 100 VDC. Maximum power draw is 10 Watts.

If equipment is to be driven requiring higher current draw, use the externally-mounted Opto 22 4-channel relay rack (PN 15973) with plug-in relay modules. These relays are rated up to 3 Amps and are available in a variety of AC or DC voltages in both normally-open and normally-closed models.

To operate equipment larger than 3-Amp draw, larger isolation relays may be externally-mounted and used in series with the on-board relays.

Table 2-5.

J2 – digital output connections			
J2 Pin	Signal	NO Relay	NC Relay
1	Ground for Over	Closes for Over	Opens for Over
2	Over		
3	Ground for Accept	Closes for Accept	Opens for Accept
4	Accept		
5	Ground for Under	Closes for Under	Opens for Under
6	Under		
7	Not used		
8	Not used		

Figure 2-4.  
Digital output connector J2 on power supply board

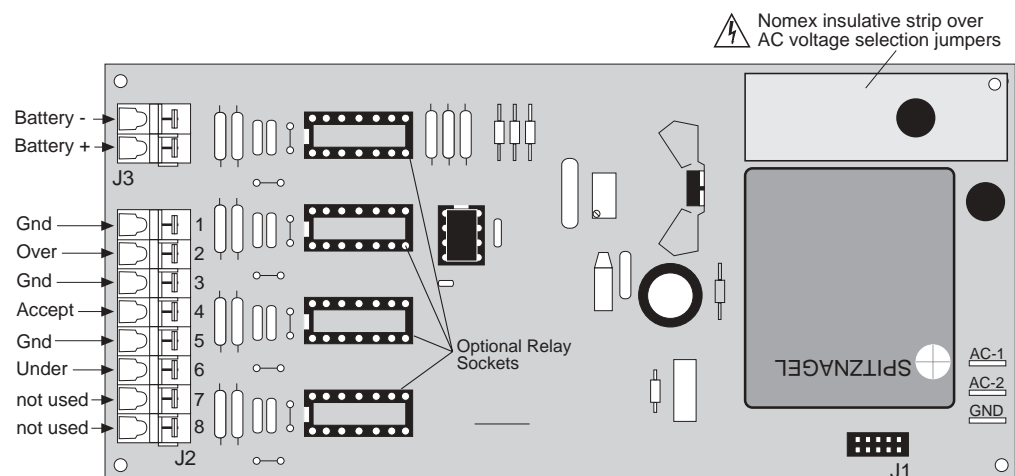



**Warning**

The optional DC battery is a lead/acid model which gives off flammable gases when charging. A vent hole in the bottom of the battery case allows these gases to escape. Do not obstruct the vent hole.

**NOTE:** The CW-80 is not UL listed for operation with the battery backup power supply.

## Optional Battery Backup Operation

A DC battery backup power supply is available on special order for factory-mounting in the checkweigher column. If AC power fails, this battery provides backup power until AC power resumes. The battery is for emergency use only, and is not designed to be the main power source used each day.

Whenever AC power to the checkweigher is ON, the battery receives a low-amperage charge to maintain its capacity. If completely discharged, the battery can be recharged in 36 hours by this method. For rapid charging in 8-12 hours, a separate AC recharging unit is available. Quick connectors allow easy disconnection of the indicator power cable and connecting the battery charger in its place. See Figure 2-5.

**Figure 2-5.**  
Backup battery and  
separate charger

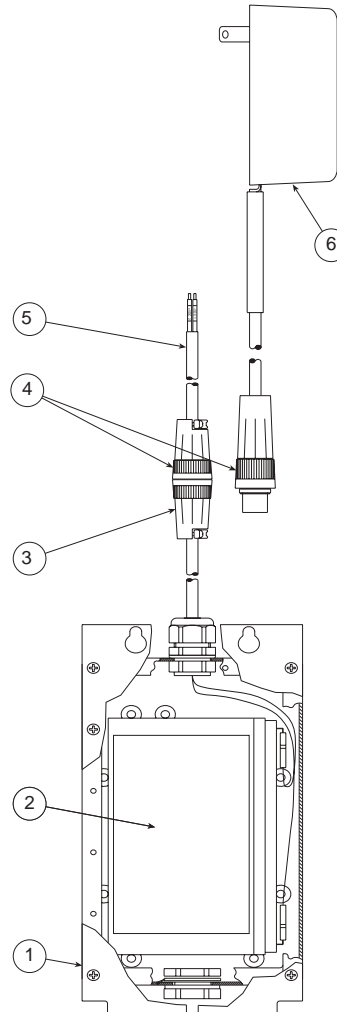

### Figure 2-5 Key

- 1 .... Battery Case and Mounting Plate
- 2 .... 6 V Battery
- 3 .... Battery Quick Connector
- 4 .... Power Cable and Charger Quick Connectors
- 5 .... Power Cable to Indicator (blue -, brown +)
- 6 .... 115 VAC to 6 VDC Battery Charger

## Board Diagrams

**Figure 2-6.**  
Power supply board  
(component side)

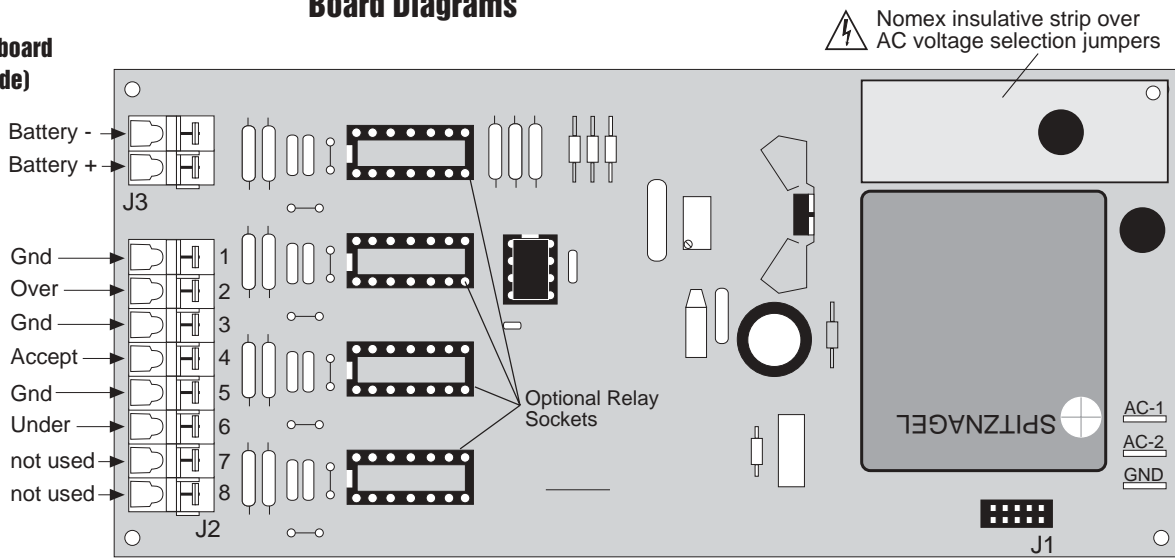

**Figure 2-7.**  
CPU board  
(component side)

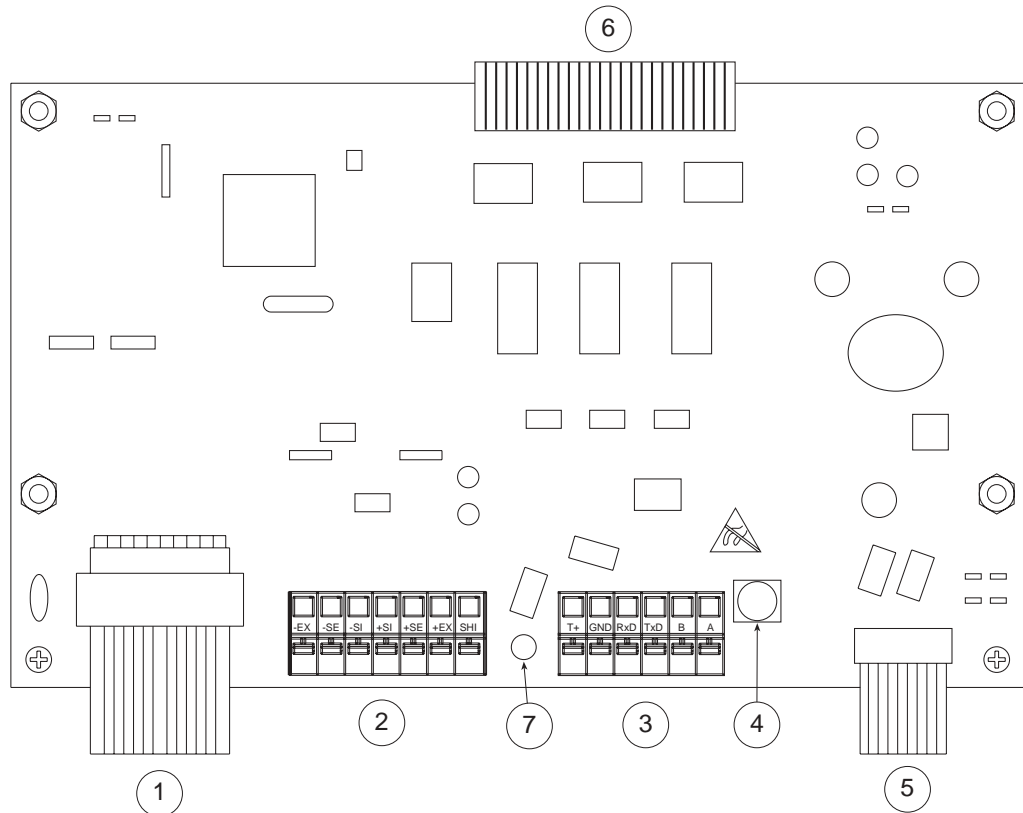

**Figure 2-7 Key**

- |   |
|---|
| 1 .... Ribbon Cable to Keypad             |
| 2 .... Load Cell Terminal                 |
| 3 .... Serial Communication Terminal      |
| 4 .... Configuration (Setup) Push Switch  |
| 5 .... Ribbon Cable to Power Supply Board |
| 6 .... Ribbon Cable to Display Board      |

## Power-Up Sequence

When the CW-80 is powered-up, the following displays appear in sequence:

1. *DISPLAY TEST* — All LED's and number segments light.
2. *SOFTWARE VERSION* — Software revision number is displayed.
3. *INITIALIZATION* — “Init” is displayed.
4. *0.0* — Scale zeros weight allowable in Auto Zero Range setting (if calibrated and in weighing mode),

*or*

*NO CAL* — “No calibration” message appears (if scale is not calibrated),

*or*

*SETUP* — “Setup” message appears (if scale is in Setup mode).

### **NOTE:**

After powering up the indicator, allow the unit to warm up at least 10 minutes before using in a legal-for-trade application.

# 3. Configuration

### In this section:

- Before You Begin
- Moving Around the Menus
- Setup Menu Chart
- Setup Menu Descriptions
- Serial Menu Chart
- Serial Menu Descriptions
- Calibration Menu Chart
- Calibration Menu Descriptions

## Before You Begin

The CW-80 Checkweigher has a push-switch on its main board to switch between the Configuration mode and Normal Operating mode. The switch is accessible through a hole in the rear panel normally closed off by a drilled-head fillister screw and water-tight washer (Fig. 3-1, #1). Removing the screw lets you operate the switch without opening the case.

To set up and calibrate the CW-80, you must be in the Configuration mode. Remove the fillister screw and washer (#1) over the set-up switch. To enter the Configuration mode, insert a small diameter object like a screwdriver or pen through the access hole until it touches the setup switch. Gently press the switch until the word "SETUP" is displayed on the front panel.

Once configuration and calibration are completed, press the switch again to return to Normal Operating mode. Access to the switch can be denied by threading a wire through fillister screws (1) and (2) shown in Fig. 3-1 below, then connecting the ends of the wire into a loop with an official regulatory seal.

**Figure 3-1.**  
Set-up switch  
behind rear panel

### Warning

*Established digital outputs may still be activated when changing parameters or calibrating. De-energize any external equipment controlled by the indicator's digital outputs while such changes are being made.*

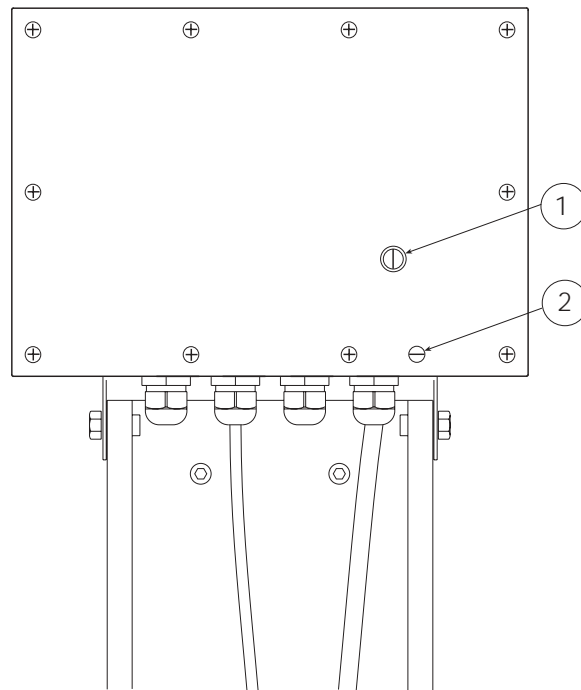

**Figure 3-1 Key**

- 1 .. Fillister screw over set-up switch
- 2 .. Fillister screw for sealing case

## Navigational keys



### UP Arrow Key:

Moves up to previous level.



### DOWN Arrow Key:

Moves down to next level.



### LEFT Arrow Key:

Moves left on same level.



### RIGHT Arrow Key:

Moves right on same level.



### ZERO Key:

Locks in numeric values.

## Moving Around in the Menus

After setting the mode switch to the Configuration mode, you have access to three menu choices that allow you to setup and calibrate the CW-80. The Configuration menus are: **SETUP**, **SERIAL**, and **CALIB**. A fourth menu item, **TEST**, is used only for factory diagnostic purposes.

To set up the CW-80, you navigate through the configuration menus with four front-panel keys that become directional keys while in the Configuration mode. Navigational keys are shown at left.

A fifth key, **ZERO** is used to lock in numerical entries.

Once the menu item to be modified is selected, you use the **UNDER** key to “drop down” to the next level to view all the possible parameter settings for that menu item. Use the **TARGET** or **ID** keys to scroll through all possible selections for that menu level.

For example, if you select **Z BAND** (Zero Band) at this level, use the **UNDER** key to move down one level to view all the possible parameters. If you wish to select **2 PC** (2%) as the parameter, use the **TARGET** or **ID** keys to scroll to **2 PC**. When **2 PC** is displayed, use the **OVER** key to lock in **2 PC** as the Zero Band setting. See Figure 3-2 below.

**Figure 3-2.**  
**Example: Setting Zero Band to 2%**

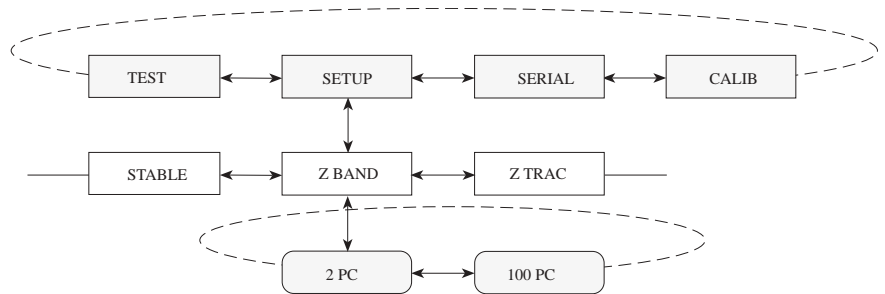

**NOTE:** When exploring the menu, be careful not to accidentally change parameter settings. Remember, the CW-80 locks in whatever is displayed when you move up a level; make sure the desired setting is on the display before you press **OVER** key to exit.

Always scroll back up to the first level **SETUP** menu when you have made changes in parameter settings. If you return to Normal Operating mode before scrolling completely up to **SETUP**, changes may be ignored.

Because the CW-80 automatically acquires Zero upon leaving Configuration mode, be certain the platter is clear when switching to Normal Operating mode.

See Figures 3-4 through 3-6 for the structure of the **SETUP**, **SERIAL**, and **CALIB** (Calibration) menus.

**Figure 3-3.**  
**Entering numeric values**

**Note:**

***Numeric Entry of Values:** Some menu items require a numeric entry. In such a case, you enter numeric values using the navigational keys as shown at right.*

*When a numeric value is displayed, one of the digits will be blinking. That digit is active and can be changed. Press the **OVER** or **UNDER** keys to make the blinking active digit larger or smaller.*



*To change which digit is blinking, press the **TARGET** or **ID** keys.*



*When you have changed the numerical display to the desired value, press the **ZERO** key to lock in that value.*



## SETUP Menu chart

The following figure provides a graphic representation of the CW-80 Checkweigher Setup menu structure. In the actual menu structure, the settings you can choose under each parameter are arranged horizontally. To save page space, menu choices are sometimes shown arranged vertically, with the factory default indicated by a check mark.

**Figure 3-4.**  
Setup menu

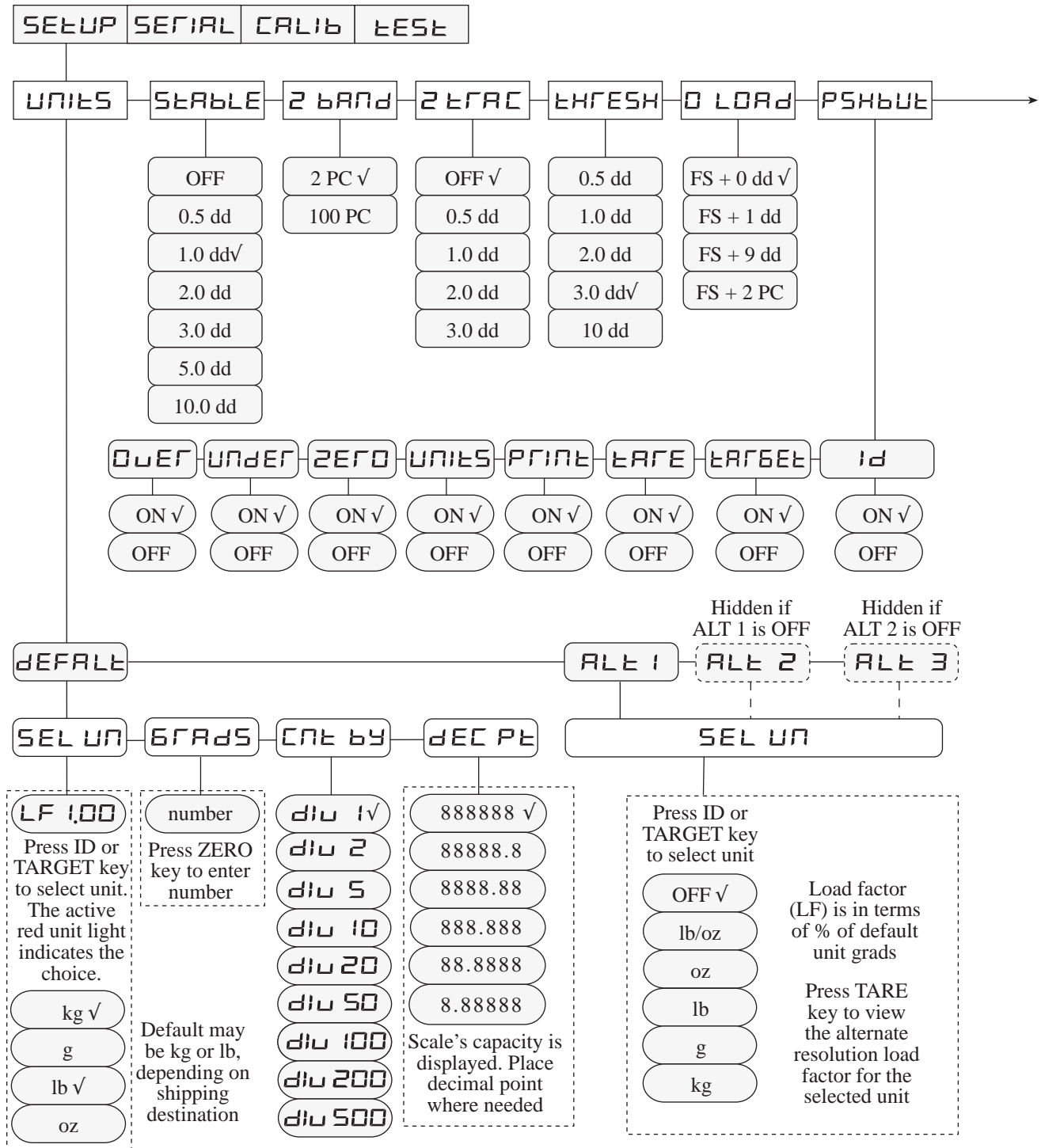

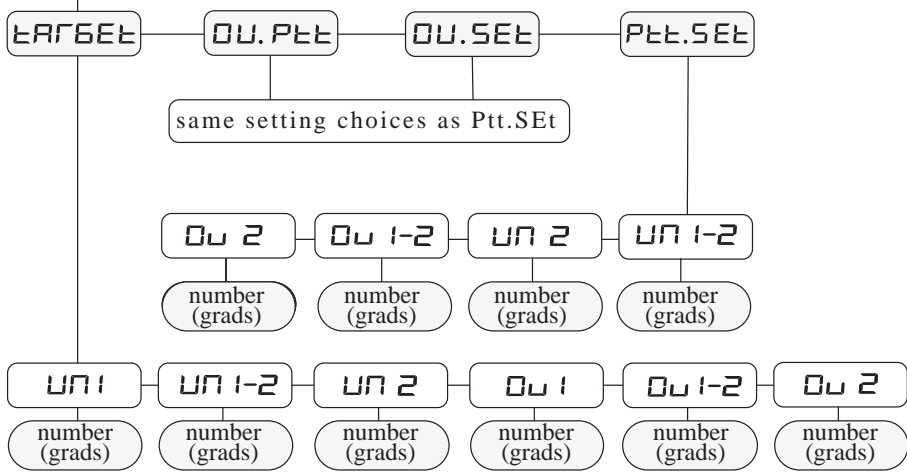
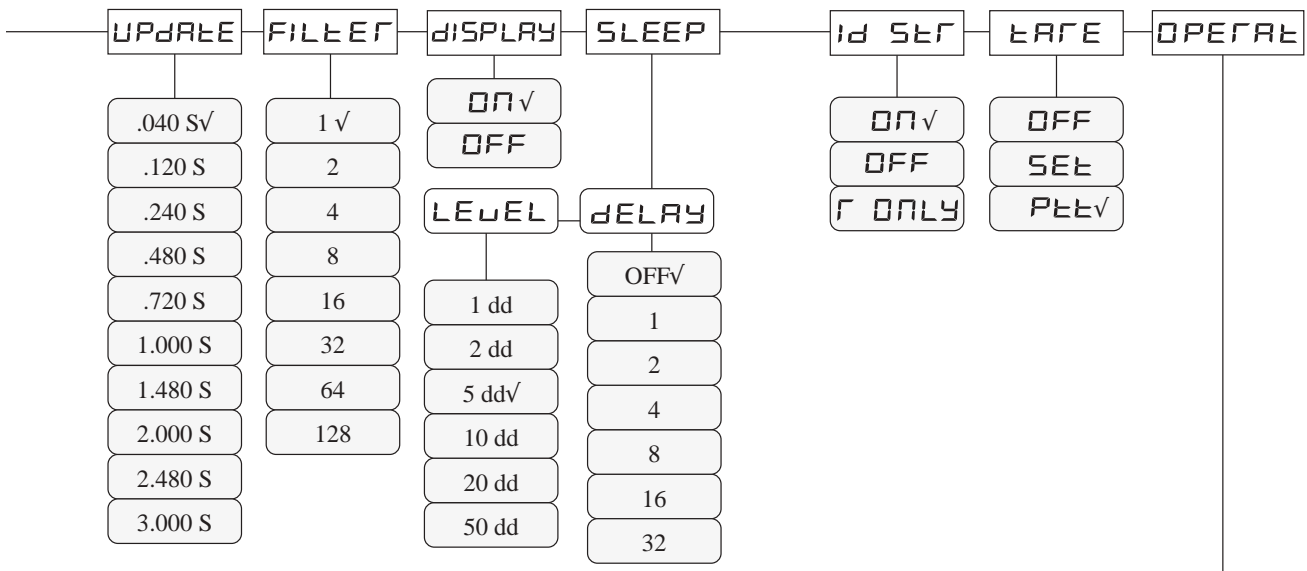





## Menu Descriptions





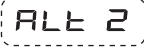
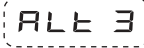

Tables 3-1 through 3-3 provide complete information about each of the main menu options. Each table describes all parameters associated with that particular menu option, the choices available for each parameter, and a general description of each parameter and related choices. The system defaults are indicated by a check mark (✓).

**Table 3-1.**

SETUP menu		
Menu Item...	Parameter...	Description...
UNITS 	DEFALT ALT-1 (ALT2)* (ALT3)*	<p><u>Units.</u> Sets up the CW-80 <i>start up</i> or <i>default</i> unit of measure (DEFALT), as well as any possible alternate units of measure (ALT 1, ALT2, and ALT3).</p> <p>Note that units selection is <b>not</b> indicated by letters on the numeric display, but by the illuminated Units LED's to the right of the numeric display. Press <b>ID</b> key or <b>TARGET</b> key to select the unit.</p> <p>From the DEFALT parameter, you can set up the default unit of measure. Alternate units of measure can be set up from the parameters ALT1, ALT2, and ALT3. The default unit of measure establishes the start up, or primary unit and determines the unit by which the scale will be calibrated. The possible choices are lb, oz, g, and kg. Units selection is indicated by the illuminated Units LED's to the right of the numeric display.</p> <p>When alternate units of measure are desired, you can use the UNITS key to set the weight display unit under ALT 1, ALT 2, or ALT 3. Note that ALT2 will be hidden unless ALT1 is active. Likewise, ALT3 will be hidden unless ALT2 is active. Each of the alternate units can be set up to be any of the possible units: lb/oz, oz, lb, g, and kg.</p>
DEFALT 	SEL UN GRADS CNT BY DEC PT	<p><u>Default.</u> Sets the default unit of measure. DEFALT establishes the primary unit of measure for the CW-80; it also determines the unit by which the scale will be calibrated.</p> <p>In addition to the units of measure, you can set the scale graduations, decimal point settings, and Count By display resolution from the DEFALT menu item.</p> <p>For the default unit of measure, the possible selections are oz, lb, g, and kg. The lb/oz unit is not allowed as a start up default unit, as the CW-80 will not calibrate with lb/oz as the default.</p>
ALT-X   	SEL UN	<p><u>ALT-X.</u> Allows you to set up any of the alternate units of measure. Note that ALT2 is hidden unless ALT1 is active (not set to OFF), and ALT3 is hidden unless ALT2 is active. To configure an alternate unit of measure, select the unit from the following list of parameter options: kg, g, lb, oz, lb/oz, and OFF. The default is OFF.</p> <p><b>LF (Load Factor)</b>            Next, select the desired load factor (LF). A load factor is a ratio of the number of graduations that an ALT-X unit has in relation to the DEFALT unit of measure.</p> <p>For example, if the CW-80 is configured so that the DEFALT unit of measure will use 2000 grads, then a load factor of (LF 0.90) will result in an alternate unit using 90% of that number of grads (0.90 x 2000 grads = 1800 grads). Similarly, a LF 1.10 will utilize 2200 grads (1.10 x 2000 grads).</p> <p>Note: The display shows the standard resolution load factor (LF) for the unit selected. You can press the <b>TARE</b> key to view an alternate resolution load factor for the unit selected. Select either the standard or alternate resolution load factor. Choosing a load factor ≤ 1.00 will result in the same or fewer graduations for the ALT-X unit of measure, maintaining Legal-For-Trade compatibility.</p>
<p><b>Note:</b>  <i>If alternate units are set up, do not change any parameters for the DEFALT unit which would affect calibration (graduations, count by display divisions, or decimal point position). Calibration will be lost and any settings established for ALT 1, ALT 2, or ALT 3 units will be lost.</i></p>		<p style="text-align: right;"><b>(continued)</b></p>

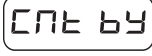





\* These alternate unit selections are visible *only* if the prior alternate unit has been activated (is not set to OFF).

Table 3-1. (continued)

SETUP menu (continued)		
Menu Item...	Parameter...	Description...
SEL UN 	<b>OFF</b> ✓ lb/oz oz lb g kg	<u>Select Units.</u> Select from the given list of units for DEFALT, ALT1, ALT2, or ALT3. The SEL UN parameter can be set to oz, lb, g, and kg for the DEFALT unit, while the SEL UN parameter can be set to OFF, lb/oz, oz, lb, g, and kg for any of the ALT-X units.  Note: Units selection is not indicated by letters on the numeric display, but by the illuminated Units LED's to the right of the numeric display. Press the <b>ID</b> or <b>TARGET</b> key to select the desired unit's red LED.
GRADS 	number	<u>Displayed Graduations.</u> Specifies the number of full scale graduations for the DEFALT unit only. Press the <b>ZERO</b> key to enter the desired number.  The graduations are selectable from 1 to 50,000 using the navigational keys. The default is 3000 graduations. See page 3-3 for the procedure for altering and entering numeric values into the CW-80.
CNT BY 	<b>DIV 1</b> ✓ DIV 100 DIV 2 DIV 200 DIV 5 DIV 500 DIV 10 DIV 20 DIV 50	<u>Count By Resolution.</u> Selects the count-by resolution (display divisions), and works in conjunction with the DEC PT parameter.  Note that choosing a selection with "dummy zeros" (10, 20, 50, 100, 200, or 500) will result in a condition where the decimal point selection in the DEC PT menu item will not appear. Instead, a "nO dP" message will be displayed.
DEC PT 	<b>888888</b> ✓ 88888.8 8888.88 888.888 88.8888 8.88888	<u>Decimal Point Position.</u> Allows you to place the decimal point position. The CW-80 combines the settings of GRADS and CNT BY to display the default scale capacity with no decimal point.  Use the Left Arrow or Right Arrow keys to place the decimal point where needed. This allows you to immediately see the current scale capacity without leaving the Setup mode to find out how the CW-80 was configured.
STABLE 	OFF 0.5 dd <b>1.0 dd</b> ✓ 2.0 dd 3.0 dd 5.0 dd 10.0 dd	<u>Stable.</u> Sets the level at which scale motion is detected by comparing the present display update with the previous update. If motion is detected, the MOTION LED is turned ON.  A setting of OFF indicates that the motion band is infinitely wide. Therefore, the MOTION LED will not turn ON. All serial port output indicates "Not in-Motion" status when transmitted. In addition, print modes, zeroing, and taring that require a stable scale before transmission will always have this condition satisfied.
Z BAND 	<b>2 PC</b> ✓ 100 PC	<u>Zero Band.</u> Selects the range of weight which may be "zeroed" off the scale. This is done by either pressing the <b>ZERO</b> key or by using automatic Zero Tracking (Z TRAC). See the Z TRAC menu for a description of the automatic Zero Tracking function.  Z BAND selections are either ±2% of full scale or 100% of full scale. The reference point at which the Zero Range is centered is the Start Up Zero acquired at power-up.





(continued)

**Table 3-1. (continued)**

<b>SETUP menu</b>			
<b>Menu Item...</b>	<b>Parameter...</b>	<b>Description...</b>	
Z TRAC 	<b>OFF</b> ✓ 0.5 dd 1.0 dd 2.0 dd 3.0 dd	<u>Zero Track</u> . Sets the condition for the CW-80 to perform automatic adjustments of the Acquired Zero. When the condition is satisfied, the adjustments are made simultaneously. The following conditions must be met for Zero Tracking to occur. <ul style="list-style-type: none"><li>• Standstill for more than 1 second</li><li>• Current gross weight within Z TRAC grads of center of zero</li></ul> If satisfied, the CW-80 makes the current weight reading the new Acquired Zero. The parameter choices indicate how many displayed graduations may be “Zeroed” OFF the scale. Selecting OFF disables Zero Tracking. Maintenance of Gross Zero is allowable only up to the limits set by Z BAND (See Z BAND definition).	
THRESH 	OFF 0.5 dd 1.0 dd 2.0 dd <b>3.0 dd</b> ✓ 10.0 dd	<u>Zero Threshold</u> . Allows you to select a threshold or reset point where automatic printing functions reset themselves to be retriggered. In some cases, it is not practical to have the CW-80 return to 0 to reset its auto print functions. See PFUNCT for more information concerning the auto-print modes supported by the CW-80. The THRS parameter is also used to give you a band greater than 0 (where the UNDER LEDs are OFF and the UNDER digital outputs remain inactive). Retriggering does not occur until an equivalent weight in excess of the THRESH value is placed on the CW-80 platter.	
O LOAD 	<b>FS + 0 dd</b> ✓ FS + 1 dd FS + 9 dd FS + 2 PC	<u>Overload</u> . Indicates where Gross Overload/Underload Blanking of the CW-80 display should occur due to a scale overload condition. The default settings is Full Scale (FS + 0 dd).	
PSHBUT 	ID TARGET TARE PRINT UNITS <b>ZERO</b> ✓ UNDER OVER	<u>Pushbutton</u> . Allows disabling any key’s primary function during normal operating mode. Secondary function of keys are not affected. Any key can be enabled or disabled within this menu (either ON or OFF). The default for each individual key is ON. The default setting (ZERO) enables all keys.	
UPDATE 	<b>.040 S</b> ✓ 1.000 S .120 S 1.480 S .240 S 2.000 S .480 S 2.480 S .720 S 3.000 S	<u>Display Update Rate</u> . Sets the time desired for updating the display (in seconds). Even though the A/D acquires new weight information at a faster rate, it may be desirable to update the display at a slower and more stable rate.	
FILTER 	<b>1</b> ✓ 4 32 2 8 64 3 16 128	<u>Digital Filter</u> . Sets the amount of mathematical averaging to be applied to the incoming weight reading. The more vibration in the area, the higher the filtering should be set. A setting of 1 indicates <i>no filtering</i> , while a setting of 128 indicates the <i>most filtering</i> .	



**(continued)**

**Table 3-1. (continued)**

SETUP menu		
Menu Item...	Parameter...	Description...
DISPLAY 	ON√ OFF	<u>Display</u> . Defines whether the numeric display will be on, or merely the bar graph. The default is ON. To disable the numeric display, select OFF.
SLEEP 	DELAY LEVEL OFF√ 1 dd 1 2 dd 2 5 dd√ 4 10 dd 8 20 dd 16 50 dd 32	<u>Sleep Mode</u> . Defines when and if the CW-80 should change to a low power state to conserve power.  DELAY is the number of minutes the CW-80 will remain at full power without seeing any activity.  The LEVEL parameter sets the amount of weight change the CW-80 must read before powering back up to full power.  <b>NOTE:</b> Sleep mode must be set to OFF for any legal-for-trade application.
ID STR 	ON√ OFF R-ONLY	<u>ID Storage</u> . Defines whether multiple nonvolatile Over/Under/Tare/Units storage registers sets are available, or whether a single set of Over/Under/Tare/Units registers are used. Choices are ON, OFF, and R-ONLY (read only).  <ul style="list-style-type: none"> <li>• ON enables multiple Over/Under/Tare/Units storage of ID numbers from 001 to 299</li> <li>• OFF disables this storage.</li> <li>• R-ONLY (read only) enables multiple Over/Under/Tare/Units storage, but protects them from accidental overwrite.</li> </ul>
TARE 	OFF√ SET PTT	<u>Tare Function</u> . Allows or disallows keyed or push-button tares. Tares can be entered either by keypad entry (SET), or by push-button acquisition from weight on the platter (PTT).  <ul style="list-style-type: none"> <li>• OFF disables the Tare function. No entry of Tare values is permitted.</li> <li>• SET enables Tare value entry with front keypad “Up” and “Down” arrow keys, incrementing or decrementing the number until desired Tare value is displayed. After a 3-second timeout with no key presses, the Tare value on the display is stored.</li> <li>• PTT enables Tare value acquisition by pressing front panel <b>TARE</b> key. Weight on platter at time of <b>TARE</b> key press is put into the current Tare register.</li> </ul>
OPERAT 	TARGET√ OU.PTT OU.SET PTT.SET	<u>Operate</u> . Allows choosing one of four different operating modes that determines how the CW-80 will establish the ACCEPT band in Normal Operating mode. The ACCEPT band falls between the settings for the first Under light (UN 1) and the first Over light (OV 1). The four modes below are explained in more detail on the following page:  <ul style="list-style-type: none"> <li>• TARGET: Target mode (installer sets OV 1 and UN 1 band width in Set Up mode)</li> <li>• OU.PTT: Over/Under Push to Tolerance mode (operator’s keypresses command the CW-80 to acquire UN 1 and OV 1 from actual weights on platter)</li> <li>• OU.SET: Over/Under Set mode (operator keys in digital UN 1 and OV 1 values)</li> <li>• PTT.SET: Push to Tolerance and Over/Under Set mode (combination of PTT and SET. Values acquired from platter can be modified digitally)</li> </ul>

(continued)

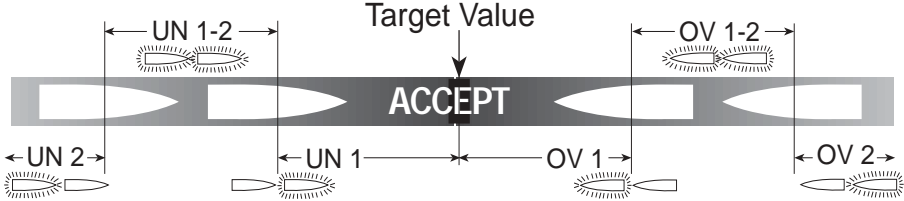
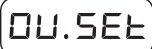
**Table 3-1. (continued)**

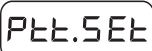
SETUP menu		
Menu Item...	Parameter...	Description...
OPERAT		
		
TARGET	UN 1 UN 1-2 UN 2 OV 1 OV 1-2 OV 2	<p><u>Target mode.</u> Pressing the TARGET key allows the CW-80 to acquire the current weight on the platter as a Target value. The Target Value is an “ideal weight” or reference value around which the over (OV 1) and under (UN 1) tolerance values are automatically adjusted during operation. All weights between UN 1 and OV 1 will be in the ACCEPT range. All UN and OV values are set in <b>grams (dd)</b> and function as follows:</p> <p>UN 1: Lower limit of ACCEPT band. Number of grads from Target value until ACCEPT goes off and first (innermost) Under light comes on.</p> <p>UN 1-2: Number of grads from UN 1 until both Under lights come on.</p> <p>UN 2: Number of grads from UN 1-2 until last (outermost) Under lights comes on.</p> <p>OV 1 Upper limit of ACCEPT band. Number of grads from Target value until ACCEPT goes off and first (innermost) Over light comes on.</p> <p>OV 1-2: Number of grads from UN 1 until both Over lights come on.</p> <p>OV 2: Number of grads from UN 1-2 until last (outermost) Under lights comes on.</p>
		
OU.SET	UN 1-2 UN 2 OV 1-2 OV 2	<p><u>Over/Under Set mode.</u> Allows operator to set the ACCEPT band by digitally entering the Over 1 and Under 1 values. Once the current Over 1 or Under 1 value is displayed, the operator uses the “Up” and “Down” keys to increment or decrement the displayed value. Once a 3-second keypad inactivity interval has passed, the CW-80 locks in the current displayed value as the Over 1 or Under 1 value. Rather than wait for the 3-second timeout, you can also press <b>TARGET</b> or <b>ID</b> to store the value. The word “STORED” appears on the display for 1 second. This mode disables the <b>TARGET</b> key.</p>
		
OU.PTT	UN 1-2 UN 2 OV 1-2 OV 2	<p><u>Over/Under Push to Tolerance mode.</u> Pressing the <b>OVER</b> or <b>UNDER</b> key instructs the CW-80 to acquire the current weight reading as the Over 1 value or Under 1 value. It displays the word “STORED” and stores the acquired weight reading in the appropriate Over or Under value register. This mode disables the <b>TARGET</b> key.</p>
		
PTT.SET	UN 1-2 UN 2 OV 1-2 OV 2	<p><u>Push to Tolerance and Over/Under Set mode.</u> This mode combines features of the OU.Ptt mode and the OU.SET mode. Over 1 and Under 1 values are first acquired from weight on the platter, as in the OU.Ptt mode. the operator may then view those values by pressing the <b>OVER</b> or <b>UNDER</b> keys. Then, by direct keypad manipulation of the keys beneath the displayed digits, he may adjust the displayed Over/Under value, as in the OU.SET mode. Once a 3-second keypad inactivity interval has passed, the CW-80 locks in the current displayed value as the Over 1 or Under 1 value. Rather than wait for the 3-second timeout, you can also press <b>TARGET</b> or <b>ID</b> to store the value. The word “STORED” appears on the display for 1 second. This mode disables the <b>TARGET</b> key.</p>
		

**Figure 3-5.**  
**Serial menu**

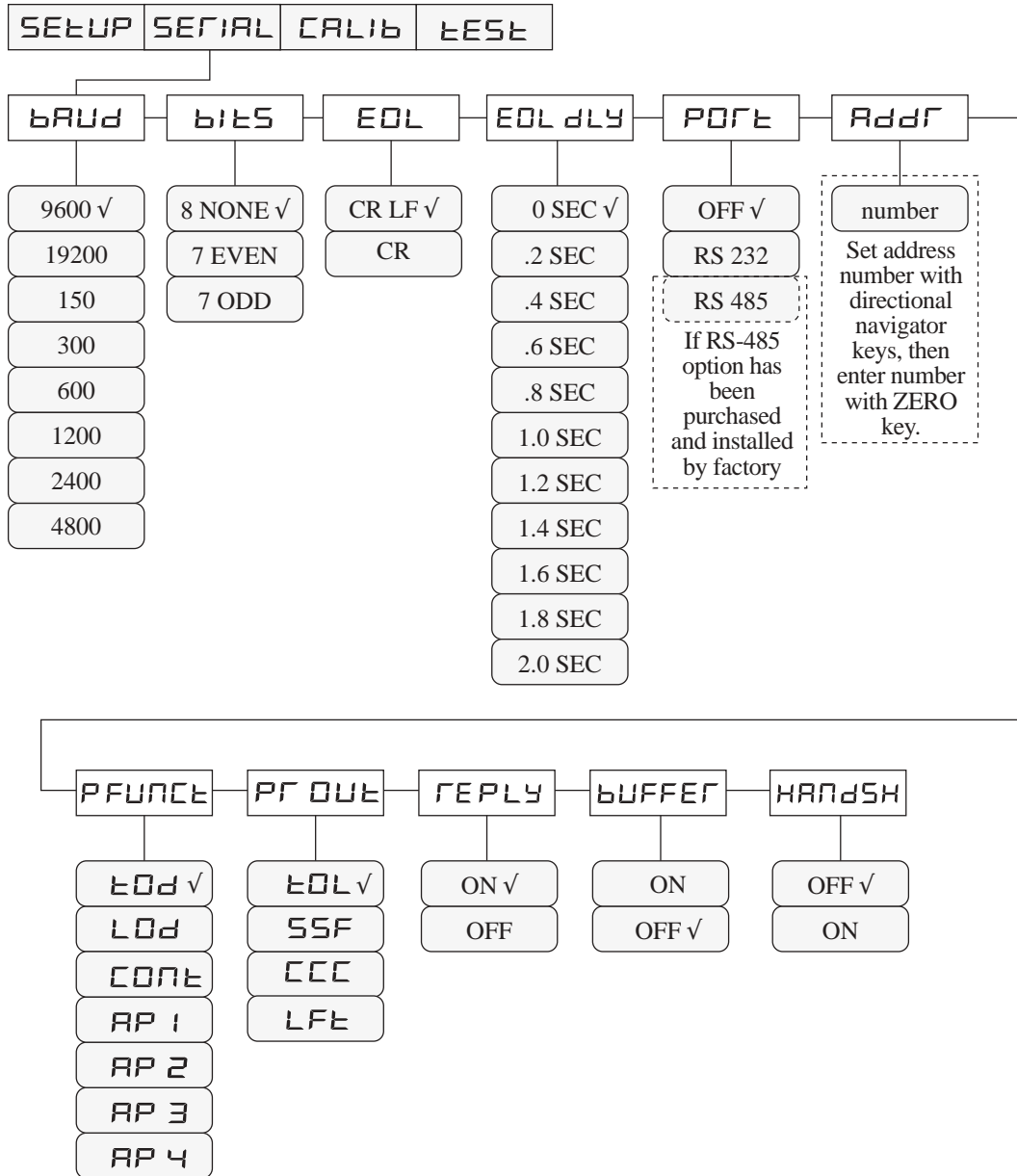

**Table 3-2.**

SERIAL menu		
Menu Item...	Parameter...	Description...
BAUD <span style="border: 1px solid black; padding: 2px;">bAud</span>	150 2400 300 4800 600 <b>9600</b> ✓ 1200 19200	<u>Baud Rate</u> . Selects the transmission speed for the serial port.
BITS <span style="border: 1px solid black; padding: 2px;">bits</span>	<b>8 NONE</b> ✓ 7 EVEN 7 ODD	<u>Bits and Parity</u> . Selects the number of data bits and parity for the serial port.
PORT <span style="border: 1px solid black; padding: 2px;">PORt</span>	<b>OFF</b> ✓ RS-232 RS-485	<u>Port for EDP Communications</u> . Selects either RS-232 or RS-485 serial communications protocol. RS-485 appears only if it has been purchased and factory-installed..
EOL <span style="border: 1px solid black; padding: 2px;">EOL</span>	<b>CR</b> ✓ CR LF	<u>End of Line Characters</u> . Selects how a line of data transmitted through the serial port ends. It does <b>not</b> indicate which EOL termination to expect with incoming transmissions.
EOL DLY <span style="border: 1px solid black; padding: 2px;">EOL dLY</span>	<b>0 SEC</b> ✓ .2 SEC .4 SEC .6 SEC .8 SEC 1.0 SEC 1.2 SEC 1.4 SEC 1.6 SEC 1.8 SEC 2.0 SEC	<u>End-of-Line Delay</u> . Sets the delay period (in seconds) from when a formatted line is terminated to the beginning of the next serial output. This allows the CW-80 to communicate with peripheral equipment with little or no receive buffers.
ADDR <span style="border: 1px solid black; padding: 2px;">Addr</span>	<i>number</i>	<u>Address</u> . Sets the address of the CW-80 for bidirectional serial communications within a network. Set the address number with the navigational keys, and then enter the number with the ZERO key. When a nonzero address is assigned, the CW-80 interprets and executes serial commands intended solely for it. When the address is not 0 but the serial command is intended for CW-80 00 (broadcast), all CW-80s interpret and execute the serial commands, but they do <i>not</i> acknowledge receipt of the serial command. The default setting for ADDR is 00, but 00 should never be selected as the checkweigher's address.

**(continued)**





**Table 3-2. (continued)**

<b>SERIAL menu</b>		
<b>Menu Item...</b>	<b>Parameter...</b>	<b>Description...</b>
PFUNCT	TOD ✓	• TOD Transmit on Demand. Transmits weigh data when <b>PRINT</b> key is pressed. Printout only occurs if scale is not in motion or out of range (Overrange or Underrange condition). If either of these conditions is not met, the print request is ignored.
<div style="border: 1px solid black; padding: 2px; display: inline-block;"> <b>P F U N C T</b> </div>	LOD	• LOD: Configures the CW-80 to remember (LATCH) to Transmit on Demand any weight data (once the <b>PRINT</b> key is pressed and the two criteria are met). The scale must not be in motion (at standstill) and must be within the scale's weighing range (NOT Over/Under range). If either of these two criteria is not met, then the PRINT request is stored until the criteria is met; the printout will occur at that time.
	CONT	• CONT: Configures the CW-80 to automatically transmit current weight data with each A/D update, (25 Hz) at 9600 baud rate or higher. The transmission rate is lower for lower baud rates. You specify the printing from the PRTOUT parameter. For the PRTOUT=CCC, the format is slightly modified by adding motion status when PMODE=CONT versus PMODE=TOD, LOD, etc.
	AP1	• AP1: Configures the CW-80 to perform automatic transmission of serial data each time the scale settles out of motion at a value that is within the scale's weighing range. This transmission happens only one time per weighment. When the scale reading goes into motion again, data output is again enabled and transmission occurs when the scale comes to a standstill again.
	AP2	• AP2: Configures the CW-80 to perform automatic transmission of serial data each time the scale settles out of motion on its transition from Start Up Zero. When an object is placed on the scale platform and the weight display stabilizes, an Auto Print occurs. The data output is then disabled until the object is removed from the scale platform, the scale returns to Start Up Zero, and the weight display settles after another object is placed on the scale platform (transmission occurs upon settling of weight transactions in the direction away from Start Up Zero). This differs from AP1 in that while in AP1 mode, the scale did not have to return to Start Up Zero in order to enable data output (it simply had to go into motion and stabilize again).
	AP3	• AP3: Similar to AP2, except that the data enable Zero point is the current system Acquired Zero rather than the Start Up Zero.
	AP4	• AP4 Configures the CW-80 to perform automatic transmission of serial data of the last stable weight reading before the scale starts back down to Acquired Zero. Once an object is placed on the scale platform, and the weight display stabilizes, the CW-80 begins recording stable readings until the object is removed from the scale platform. The last stable weight reading is the desired transaction weight, (an Auto Print will occur, reflecting the last stable weight reading). The data output is then disabled until the weight reading drops back to Acquired Zero and returns to a nonzero stable weight reading. Note that this differs from AP1 through AP3 in that AP4 records the last nonzero stable reading rather than the first nonzero stable reading.

**(continued)**



**Table 3-2. (continued)**

SERIAL menu		
Menu Item...	Parameter...	Description...
PR OUT 	<b>TOL</b> ✓ SSF CCC LFT	<p><u>Printout</u>. Selects the type of print data format to be used when transmitting through the serial port. The four possible selections are listed below. See Section 7 for more detail on print formats.</p> <p>TOL: tolerance format            SSF: simple short format            CCC: Consolidated Controls format            LFT: legal-for-trade format</p> <p>The default is TOL.</p>
REPLY 	<b>ON</b> ✓ OFF	<p><u>Reply</u>. Determines whether the CW-80 will respond with an acknowledgment when issued a EDP port command (other than one intended for CW-80, 00 broadcast). The selections are either ON or OFF, with ON being the default selection. This setting does not affect requests for status, weight data, tolerance values, etc. The Acknowledgment is defined as the following ASCII character sequence:</p> <p>[ "*" ] [ EOL ]</p> <p>where</p> <p>[ "*" ] is ASCII 2A Hex            [ EOL ] is the End of Line termination as set in the EOL menu item.</p>
BUFFER 	ON <b>OFF</b> ✓	<p><u>Buffer</u>. Determines whether the CW-80 will power up buffering all printout transactions. OFF is the default setting. When set to ON, all transactions are buffered until a serial port command requests the transaction buffer be transmitted. When set to OFF, all transactions are sent when available. However, serial port commands may be used to temporarily override this function. The initial setting is remembered as "the Power Up default".</p>
HANDSH 	<b>OFF</b> ✓ ON	<p><u>Handshake</u>. Selects the XON/XOFF software handshaking method of serial communications whereby data is transmitted only when the device (such as a printer) is ready to receive.</p>

**Figure 3-6.**  
Calibrate menu

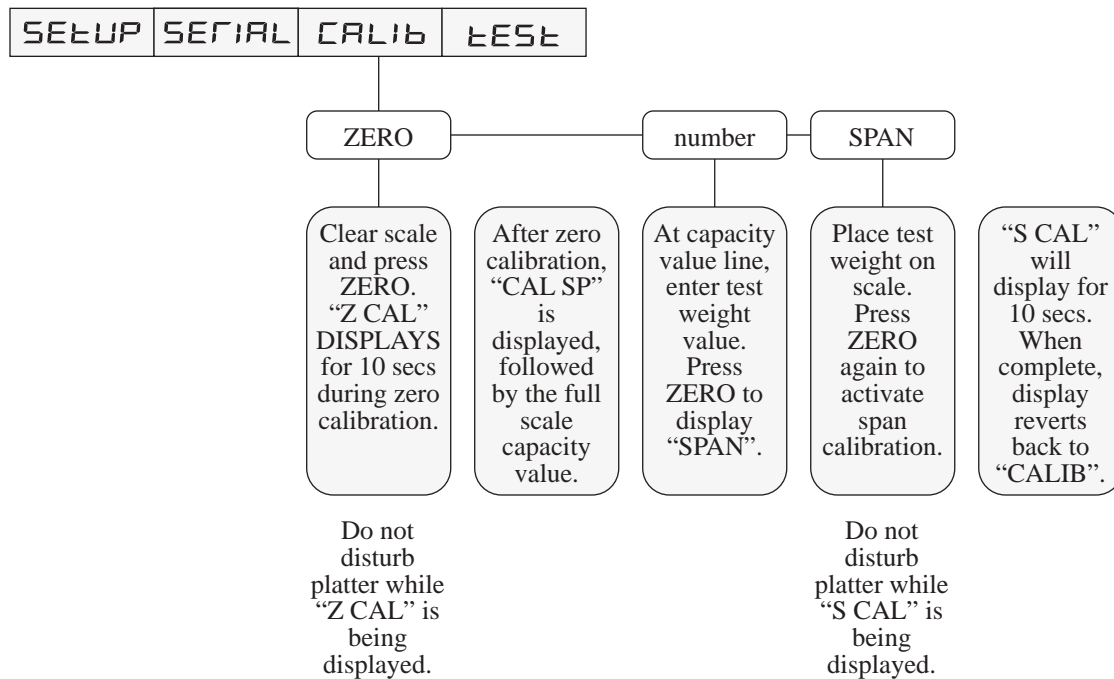

**Table 3-3.**

CALIB menu		
Menu Item...	Parameter...	Description...
ZERO	Use for zero calibration.	Clear scale and press ENTER key to display "Z CAL" to activate zero calibration. The display lasts for 10 seconds while Checkweigher makes a reading of the deadload or ZERO signal from the load cell. After zero calibration, "CAL SP" is displayed briefly, followed by display of the full scale capacity value.
number	Use to enter test value.	If you plan to use a test weight equal to the capacity value displayed, press ENTER. The display prompt "SPAN" appears. If you plan to use a less-than-capacity test weight, enter that test weight value and press ZERO to display "SPAN". You may change the test weight value by using the navigational keys for numeric entry of the desired test weight.
SPAN	Use for span calibration.	While "SPAN" is displayed, place test weight on scale and press ZERO key to activate span calibration. The working display "S CAL" lasts for 10 seconds. When complete, the display reverts back to "CALIB".

## 4. Calibration

### In this section:

- Overview
- Calibration Procedure

### Overview

The CW-80 Checkweigher is calibrated from the CALIB menu and stores the results in nonvolatile memory on the CPU board. Calibration is done through the CALIB setup menu shown below, which includes screen displays seen during the process.

### Calibration Procedure

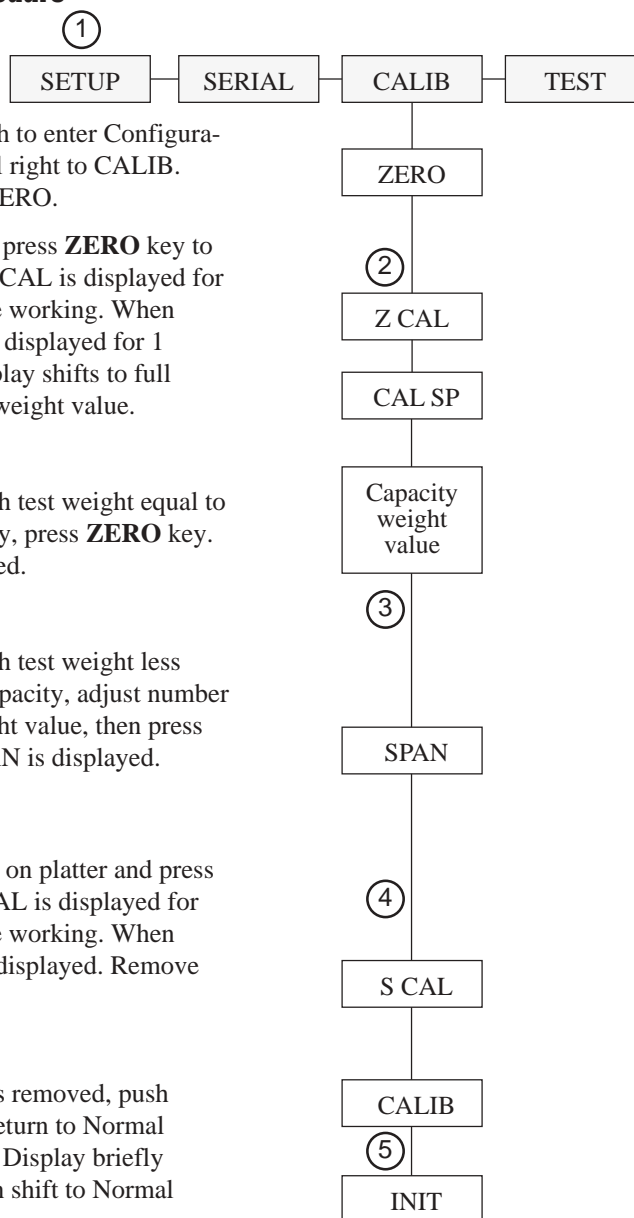

- ① Push setup switch to enter Configuration mode. Scroll right to CALIB. Scroll down to ZERO.



- ② Clear platter and press **ZERO** key to calibrate zero. Z CAL is displayed for 10 seconds while working. When done, CAL SP is displayed for 1 second, then display shifts to full scale (capacity) weight value.



- ③ If calibrating with test weight equal to full scale capacity, press **ZERO** key. SPAN is displayed.

If calibrating with test weight less than full scale capacity, adjust number to your test weight value, then press **ZERO** key. SPAN is displayed.



- ④ Place test weight on platter and press **ZERO** key. S CAL is displayed for 10 seconds while working. When done, CALIB is displayed. Remove test weights.



- ⑤ With test weights removed, push setup switch to return to Normal Weighing mode. Display briefly shows INIT, then shift to Normal Weighing Mode.

### Note:

Because the CW-80 automatically acquires Zero upon leaving Configuration mode, be certain the platter is clear when switching to Normal Operating mode.

## 5. Operating Modes

---

### In this section:

- Before You Begin
- Overview of Operating Modes
- TARGET Mode
- OU PTT Mode
- OU SET Mode
- PTT/SET Mode
- Setting Over and Under Tolerance Values
- Setting Tare Values
- Using ID Storage Registers
- Zeroing Scale
- Test Mode

### Before You Begin

The CW-80 has four separate operating modes to accommodate different applications. The major difference between these four operating modes is the manner in which Under/Accept/Over tolerance values are established, and the manner in which they can be changed once set.

**TARGET** (Target)—Allows the installer to pre-set all tolerance values while in the Configuration mode. In Normal Weighing mode, the operator then simply places a sample weight on the scale and presses the **TARGET** key to acquire the target weight. The lower and upper limits of the Accept band automatically shift in relation to the target weight, based on previous settings of all tolerance values entered at **SETUP**.

**OU PTT** (Over/Under Push To Tolerance)—Prohibits the operator from digitally entering values with the keypad. Requires the operator to place actual weights on the scale then press keypad buttons that instruct the CW-80 to acquire lower and upper Accept band tolerance values from the actual weights on the scale.

**OU SET** (Over/Under Set)—Allows the operator to digitally set the Accept band tolerance values using keypad buttons while in Normal Weighing mode.

**PTT/SET** (Push To Tolerance and Set)—Combination mode that allows the operator to have the CW-80 acquire Accept band tolerances from actual weights on the scale, but then gives the operator an opportunity to digitally modify those values directly afterward.

If your application requires using one of the four modes which allows the operator to modify the Accept band tolerances, and you don't want the operator to have this power, the installer can disable the **OVER** and **UNDER** keys in the Configuration mode. As these are the keys used to alter tolerances, disabling them has the effect of shutting the operator out from altering settings made by the installer.

With any of these four operating modes, the installer also can choose between two methods for establishing tare values: (1) He can choose a selection that requires the operator to acquire tare values only from actual weights placed on the scale (**TARE — PTT**), or (2) He can choose to allow the operator to enter tare values digitally (**TARE — SET**). See description for **TARE** menu item in Table 3-1.

Even though the **ACCEPT** band tolerance limits can be set and/or changed by the operator in certain modes, please note that the settings controlling the outer LED arrowheads on the Under/Accept/Over display bar can only be set or changed by the installer in Configuration mode.

## Overview of Operating Modes

The following pages use graphics to summarize how each operating mode functions. This page provides a key (using the two figures below) for reading those graphics on the following pages. Note that all graphics assume you are using a scale with 30 lb capacity, set up for 3,000 grads (20 x .01), a Count By of 1, and 2 decimal places.

An **OVER** or **UNDER** button icon with numbers below indicates *Un 1* or *Ov 1* weight values digitally entered using the keypad.

All settings above the **UNDER/ACCEPT/OVER** display bar are made by the operator in normal weighing mode, and are in the default unit of **weight**.

All settings below the **UNDER/ACCEPT/OVER** display bar are made by the installer in Configuration mode, and are in **graduations**.

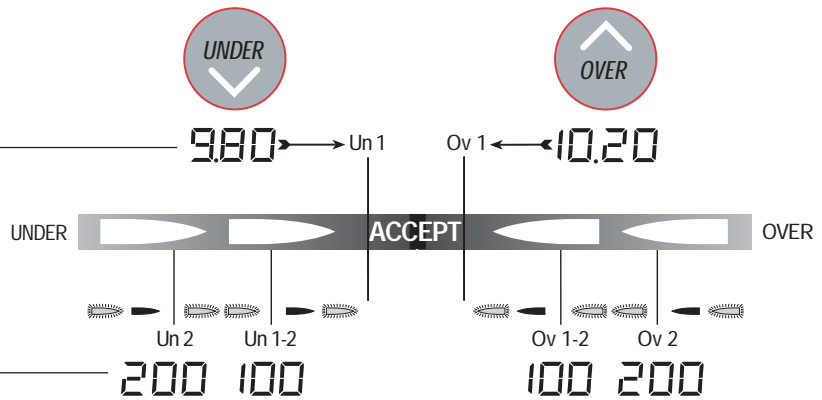

### NOTE:

Grad settings are successively cumulative to **Ov 1** and **Un 1** settings. For instance, the LED light furthest left (*Un 2*) comes on when the cumulative grad settings for **Un 1** and **Un 1-2** have been surpassed.

A scale and container icon indicates the operator has set **Ov 1** or **Un 1** by placing an actual weight on the scale, then pushing either the **OVER** or **UNDER** button.

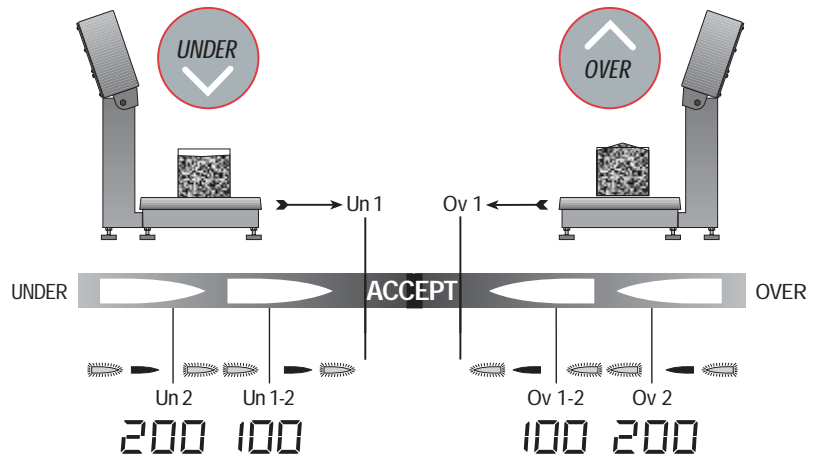

In **TARGET** mode, all tolerances (Un 1, Un 1-2, Un 2, Ov 1, Ov 1-2, Ov 2) are pre-set by the installer. The operator places a sample weight of the product on the scale and presses the **TARGET** key. This target weight is acquired by the CW-80. In this example, the lower ACCEPT point (Un 1) is set for 20 grads below, and the upper ACCEPT point (Ov 1) is set for 20 grads above this acquired target weight. All other tolerance values controlling the Under/Accept/Over LED display lights are pre-set by the installer as follows:

Un 1-2 = 100 dd    Ov 1-2 = 100 dd  
 Un 2 = 200 dd    Ov 2 = 200 dd

**NOTE:** The operator can temporarily override the established settings for the lower (Un 1) and upper (Ov 1) limits of the ACCEPT band by pressing the **UNDER** key to display the Un 1 weight setting, then digitally altering the value with keypad buttons. The Ov 1 weight setting can be altered in a similar manner with the **OVER** key. These altered Un 1 and Ov 1 values remain active until either the **TARGET** key is pressed again, or the CW-80 is powered down.

## TARGET Mode

Checkweigher-Acquired Weight Value by Pressing TARGET Key

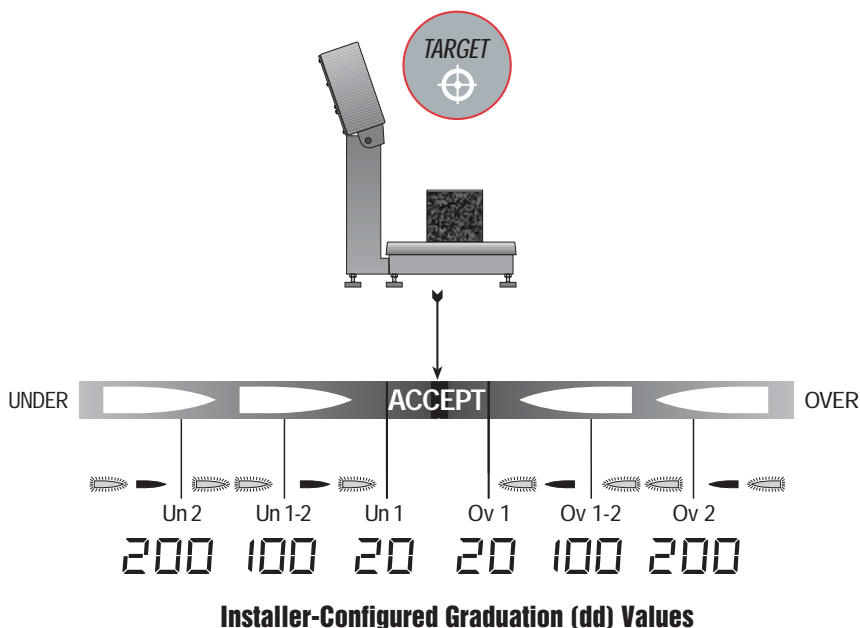

In **OVER/UNDER PUSH TO TOLERANCE** mode, the operator sets the ACCEPT band by placing an unacceptably-low weight on the scale and pressing **UNDER** to set Un 1. He then places an unacceptably-high weight on the scale and presses **OVER** to set Ov 1. Any weights between those limits will fall into the ACCEPT band.

All other tolerance values (Un 1-2, Un 2, Ov 1-2, Ov 2) controlling the Under/Accept/Over LED display lights are pre-set by the installer at **SETUP** time.

## OU PTT Mode

Checkweigher-Acquired Weight Values by Pressing OVER or UNDER keys

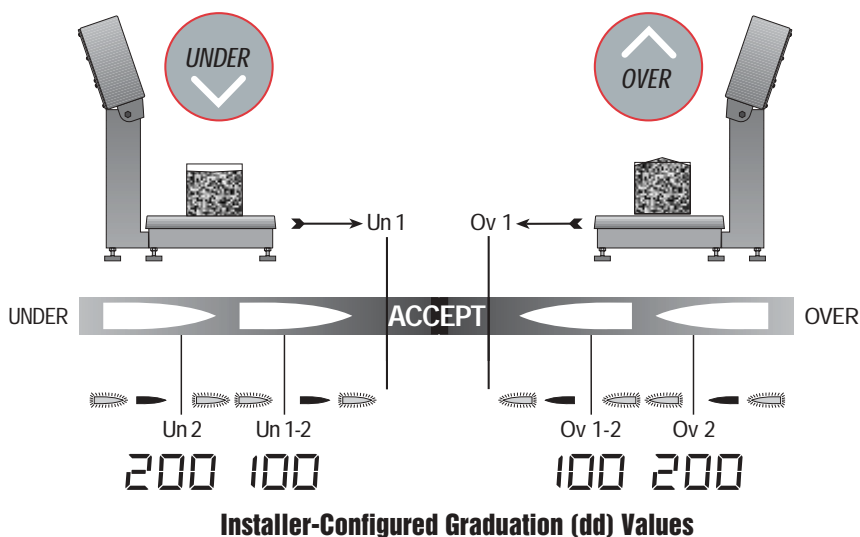

In **OVER UNDER SET** mode, the lower (Un 1) and upper (Ov 1) limits of the **ACCEPT** band are entered digitally through the keyboard by the operator. The operator presses the **UNDER** key, then enters the Un 1 value. He then presses the **OVER** key and enters the Ov 1 value. Weights falling between these limits will be in the **ACCEPT** range.

All other tolerance values (Un 1-2, Un 2, Ov 1-2, Ov 2) controlling the Under/Accept/Over LED display lights are pre-set by the installer at **SETUP** time.

### OU SET Mode

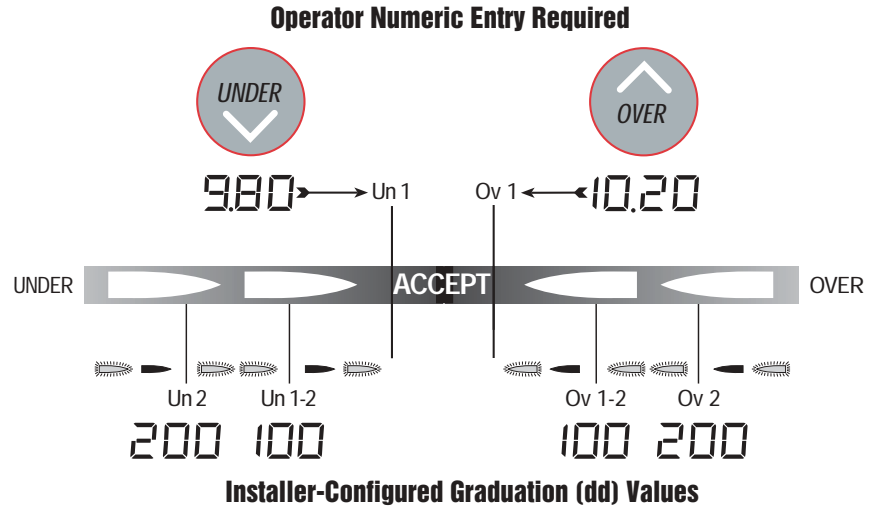

**PUSH TO TOLERANCE/SET** mode combines both methods (acquired and digitally set) for establishing the **ACCEPT** band. The Un 1 value is first acquired as in **PTT** mode on previous page. This acquired value can then be altered by pressing **UNDER** again and digitally modifying the value. Ov 1 operates in a similar fashion.

All other tolerance values (Un 1-2, Un 2, Ov 1-2, Ov 2) controlling the Under/Accept/Over LED display lights are pre-set by the installer at **SETUP** time.

### PTT/SET Mode

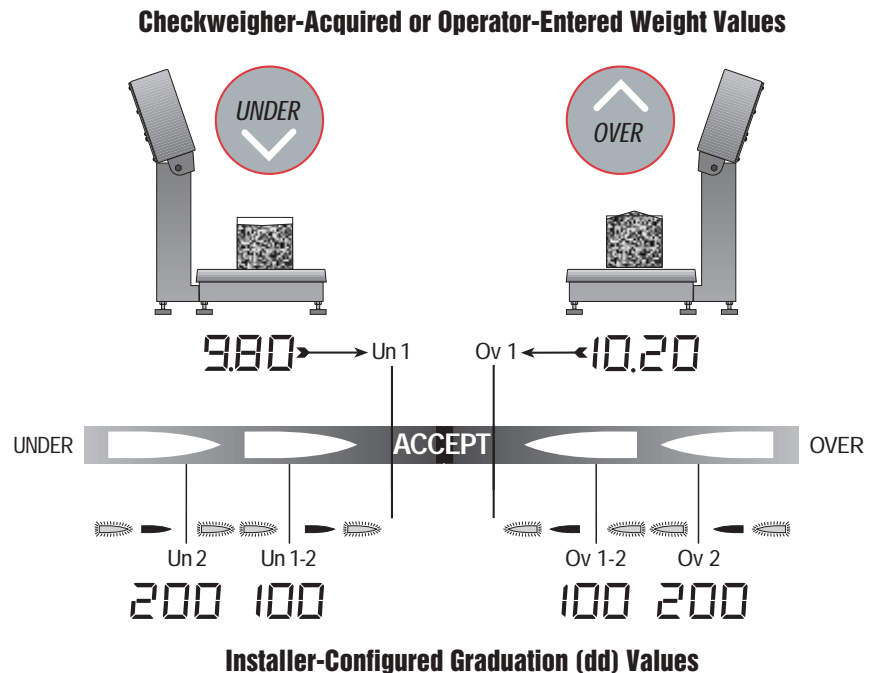



## Displaying and Setting Over and Under Tolerance Values

This section explains how to set or alter the values that define the ACCEPT band.

When in OU SET mode, the operator uses keypad buttons to digitally set or alter Over (Ov 1) and Under (Un 1) values around the ACCEPT band.

When in TARGET or PTT/SET mode, these Ov 1 and Un 1 values defining the ACCEPT band are initially acquired from weights on the platter, but can then be altered by the operator using keypad buttons.

Setting or altering the Over (or Under) value involves four main steps. The **OVER** and **UNDER** keys must not have been disabled by the installer. The following explains how to set or alter the Over value. The Under value functions in the same manner by using the **UNDER** key.

1. Press the **OVER** key to display the current Over value.
2. Set the direction you wish to modify the value by pressing the **OVER** key to make the value larger, or the **UNDER** key to make it smaller.
3. Digitally alter the displayed value using the **ZERO**, **UNITS**, **PRINT** and **TARE** keys. Remember that these keys will alter the display only in the direction you established in Step 2. If you accidentally go beyond your new desired value, you must return to Step 2 to reverse the direction. Once the direction has been reversed, you may then alter the value in the opposite direction toward your new desired value.
4. Allow the CW-80 store away the new value. The CW-80 automatically stores the displayed value if no keys are pressed for 3 seconds.

The following example illustrates changing the Under (Un 1) value from 9.80 lbs to 9.75 lbs.

### STEP 1:

Press the **UNDER** key. The Under value (Un 1) displays, and both Under LED's flash—indicating you are now in an Under Display/Set mode

#### Note:

This Under Display/Set mode timesout after 3 seconds without a key press. If any key is pressed, the 3-second interval resets. The Over Display/Set mode operates in similar fashion.





## STEP 2:

Establish the direction (smaller or larger) in which you want to alter the displayed value by pressing the appropriate **OVER** or **UNDER** key. In this example, we will make the value smaller, so press **UNDER**.

### Note:

Now that the direction has been established, the keys shown at right change the indicated digits in that direction while in the Display/Set mode. In this example, each press of a key (except the **TARE** key) reduces the value of the digit above it by 1. The least-significant digit (controlled by the **TARE** key) is reduced by 5, which is the size of the display division (Count By setting). When a digit is reduced below zero, that value borrows from the next-significant digit.

If a time-out occurs before your setting is done, repeat steps 1 & 2 again.

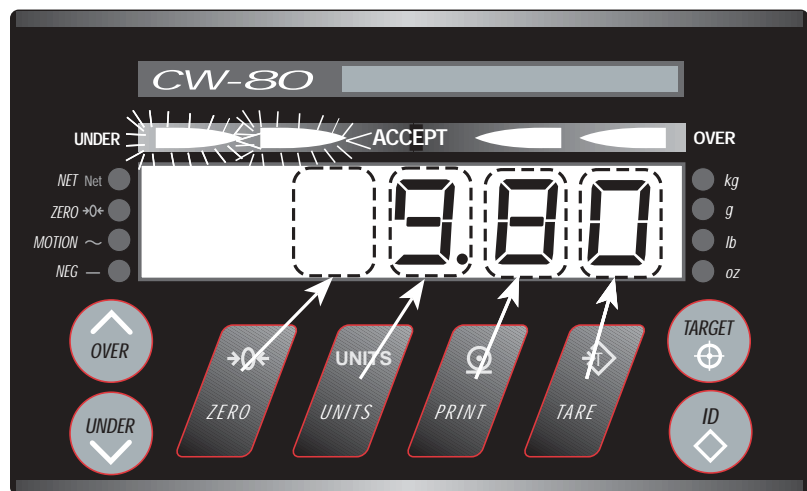

## STEP 3:

Press the **TARE** key beneath the 0 digit to reduce that digit by 5 (1 display division). Notice that when the 0 digit is reduced by five, the effect carries over to the next digit (9.80 becomes 9.75).



#### STEP 4:

Allow the CW-80 to store the new 9.75 value. The CW-80 does this automatically if no keys are pressed for 3 seconds.

#### Note:

If any key is pressed other than those previously mentioned, the CW-80 aborts the display of the Under value and retains the currently displayed value as the new Under value. The CW-80 display goes blank for 1/2 second and returns to the previous weight display mode.



#### Alternate Method for Changing Over or Under Values

An alternate method for changing values is useful when the amount to be changed is small. This method, called Auto Rolling, puts the display into a constantly increasing (or decreasing) mode which you can easily stop when your new desired value is reached. The display rolls at a speed of 2 display divisions per second for the first three seconds. If no stop has been signalled within that time, the rolling speed increases to 10 display divisions per second. If your desired value is exceeded, the direction can be reversed to roll the displayed value back to your target.

To use Auto Rolling:

1. Press either **OVER** or **UNDER** to display the Ov-1 or UN-1 value.
2. Press **OVER** or **UNDER** to establish the direction of movement.
3. Press that same button again to begin Auto Rolling.

To reverse direction, press the opposite button as pressed in step 2. Press that button again to begin Auto Rolling in the opposite direction.

4. To stop the display rolling, press either the **OVER** or **UNDER** button.

## Setting Tare Values

The CW-80 allows two methods for establishing tares. The most common method involves placing the actual tare weight on the scale, then pressing **TARE** to allow the scale to acquire that value. If this is the method of choice, the **TARE** menu must be set to PTT (Push To Tare) in Configuration mode.

The second method allows tares to be entered digitally by using keyboard buttons. With this method, the tare value is entered using a keypad procedure similar to the one for setting Over or Under values. If this is the method of choice, the **TARE** menu must be set to SET in Configuration mode.

### Note:

If the setup menu item **TARE** is set to the **PTT** parameter, pressing the **TARE** key will not display the tare value, but will acquire a new Tare value from the current weight on the scale platter. See the **TARE** description in Section 3, Configuration, for more information.

Press **TARE** to display the tare value. All Over and Under lights come on.



### To Display the Current Tare Value

If **TARE** is set to the **SET** parameter, then pressing the **TARE** key will instruct the CW-80 to display the current Tare value and to flash all Over and Under LEDs indicating the Tare Display/Set mode. The Units LED corresponding to the current unit of measure will also be lit, but not flashing. This Tare Display/Set mode lasts for 3 seconds unless a key is pressed, which resets the 3-second time interval.

The CW-80 response is dependent on which key is pressed:



Press **OVER** or **UNDER** to set the direction of adjustment.



### The OVER or UNDER keys

Pressing either of these keys while the Tare value is displayed will establish the direction of adjustment. You *must* set the direction of adjustment with the **OVER** or **UNDER** keys before trying to modify the displayed tare value. Pressing this key again will activate an Auto Rolling sequence in the adjustment direction. Pressing either the **OVER** or **UNDER** key again will stop Auto Rolling, and pressing the opposite key will reverse the Auto Rolling direction.

**Note:**

If you don't prefer the Auto Rolling method of adjusting tare values, you may use the Digit Adjustment method.

**Digit Adjustment Keys**

Pressing any of the keys (**ZERO**, **UNITS**, **PRINT**, **TARE**) beneath the display digits while the Tare value is displayed will increment or decrement the digit above the key by 1 each time the key is pressed.

**Any Other Key**

If any other key is pressed other than those previously mentioned, the CW-80 will abort the display.

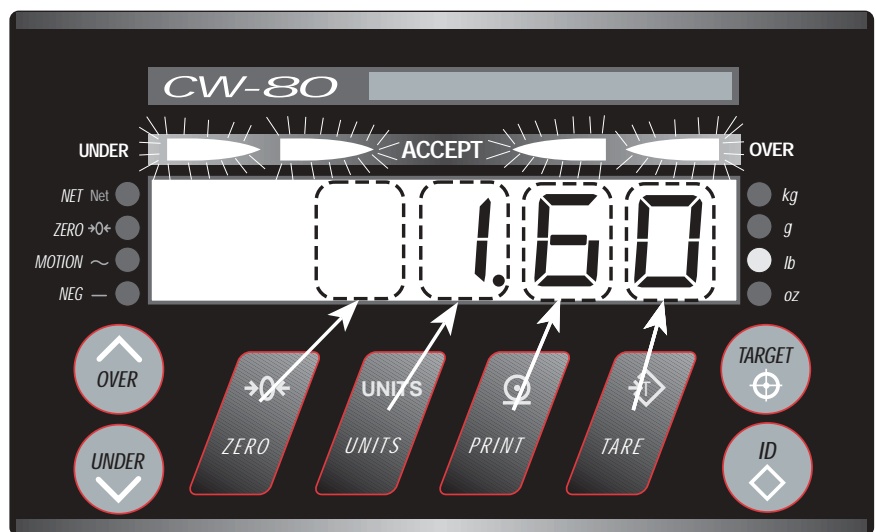

In this example, the CW-80 has the tare value displayed in Tare Display/Set mode.

The **OVER** key has already been pressed to establish the adjustment direction as increasing.

Pressing the **UNITS** key once as shown at right increments the digit "1" to "2".



### 3-Second Timeout to Store Tare Value

If no key is pressed for 3 seconds, the tare value on the display is stored into memory, and the word “STORED” appears on the display for 1/2 second. Note that this stored value overwrites any value which might currently be in memory. The display then returns to Normal Weighing mode.

If a timeout occurs before your final desired tare value was displayed, you can get back into the Tare Display/Set mode by repeating the process of: 1) Tare display, 2) Set adjustment direction, 3) Adjust value, and 4) Timeout to overwrite existing tare and store new tare in memory.

The following example illustrates setting a tare value of 1.60 lbs.

#### STEP 1:

*Press TARE to display the current tare value. This places the CW-80 in Tare Display/Set mode.*



#### STEP 2:

*Set the direction (smaller or larger) in which you want to alter the displayed value by pressing the appropriate OVER or UNDER key. In this example, we will make the value larger, so press OVER.*



**STEP 3:**

Press the **PRINT** key 6 times to increment the digit above the key from 0 to 6.

**Note:**

If a digit is incremented beyond 9, the effect will carry over to the next column.



**STEP 4:**

Press the **UNITS** key once to increment the digit above the key from 0 to 1.



**STEP 5:**

Allow 3 seconds for the unit to timeout and store 1.60 as the new tare value. After displaying the "STORED" message, the CW-80 automatically shifts back into Normal Weighing mode.



## Using ID Storage Registers

When the Configuration menu item ID STR is set to either ON or R ONLY, the multiple ID storage feature is activated. Any of 299 available ID registers can be selected. Each ID number must have four distinct categories of information:

- Over tolerance value (Ov 1)
- Under tolerance value (Un 1)
- Tare value
- Unit of measure

For any given ID, the unit of measure field determines the units for all of the other fields, Over, Under, and Tare. Examples of the structure of the ID storage table are shown in Table 5-1. ID register sets can be entered using either the keypad or the serial port.

### Note:

*ID's can have any of the predetermined valid units of measure associated with them.*

**Table 5-1.**

ID Storage Table Structure				
ID #	Over Tol Value	Under Tol Value	Tare Value	Unit of Measure
1	12.65	12.50	0.50	lb
2	15.65	15.00	0.75	lb
3	10.10	10.00	0.25	kg
4	xx.xx	yy.yy	0.zz	oz

## Keyed ID Selection

### Note:

*You may also establish or store registers manually.*

*To use the manual method:*

1. *Set or acquire Accept band tolerances.*
2. *Set or acquire tare value.*
3. *Press **ID** key.*
4. *Use navigational keys to display the ID number desired.*
5. *Press **ID** key to store the current Over/Under/Tare/Units settings in the ID register. "STORED" will appear on the display.*

In order to select and work with a set of Over/Under/Tare/Units registers, you can key in the ID number associated with the desired information stored in the table. To accomplish this, you press the **ID** Key followed by any of several navigational keys until the desired ID number appears on the display. The special ID selection navigational keys that you may use are shown in Table 5-2.

**Table 5-2.**

ID Select Navigational Keys	
Key Function	Keypad Position
Set Direction Upwards	OVER
Set Direction Downwards	UNDER
Adjust ID by 1	TARE
Adjust ID by 10	PRINT
Adjust ID by 100	UNITS
Set ID to 0	ZERO



To illustrate how you can select an ID register set and make its contents the current operating parameters, see the following example.

Assume that the current ID number selected is 34, and you want to select ID number 50. The following key sequence allows you to select the register set assigned to ID 50, and make its contents the current operating parameters.

Example 1:

Step	Operator Action	Table Structure
1	Press <b>ID</b> key.	CW-80 displays ID 34.
2	Press <b>OVER</b> key to set direction upwards.	
3	Adjust the numerical digits with the <b>UNITS</b> , <b>PRINT</b> , or <b>TARE</b> keys beneath them (as shown below) until 50 is displayed. If you go too far, press the <b>UNDER</b> key to reverse direction.	Display changes from ID 34 to ID 50.
4	Wait 3 seconds without a keypress.	The CW-80 recalls the Over/Under/Tare/Unit information associated with ID 50. These values become the current Over/Under/Tare values. The display units change to the unit of measure recalled for ID 50 register. Display shows "RECALL" then returns to Normal Weighing mode.

**Note:**

The **ZERO** key is a special shortcut key that, when pressed while an ID number is displayed, will immediately make the current ID number ID 0.

**Note:**

Whenever you establish a new ID register, or write over an existing one, "STORED" is displayed.

Whenever you read an ID register, "RECALL" is displayed. The contents of that ID number become the new operating parameters (Over/Under/Tare/Units) for all subsequent weighments.

**Note:**

Pressing any of the keys (**UNITS**, **PRINT**, **TARE**) beneath the display digits while the ID number is displayed increments or decrements the digit above the key by 1 each time the key is pressed.

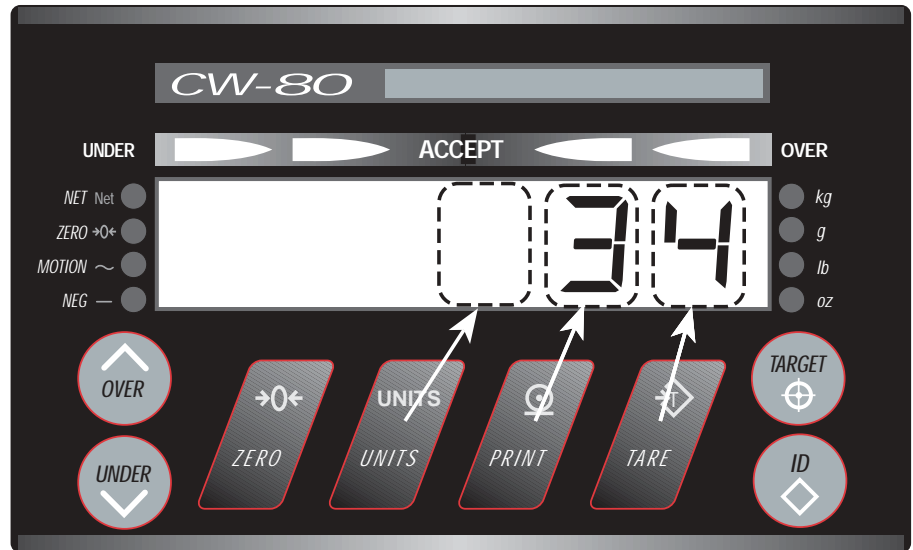



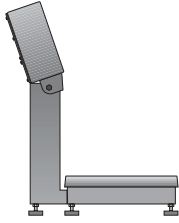

## Zeroing the Scale

Upon power up, or upon exiting the Setup menu, the CW-80 will automatically zero off weight on the platter up to the amount established in the Zero Band setting. To prevent unwanted zero shifts, be certain platter is empty when powering up the indicator and when exiting the Setup mode.



In weighing mode, the CW-80 will also zero off any gross weight on the scale and display zero when the ZERO key is pressed. The amount of weight the CW-80 will zero off in this manner is limited by the zero band (ZbANd) setting in the Setup menu. Choices are 2% of full scale (2PC) or 100% of full scale (100PC).

## Test Mode



The Test mode is a first-level menu item used only for diagnostic purposes by the factory. It is accessible only when in Setup, and displays a number of display divisions which has a resolution 10 times higher (0.1dd) than normal weighing mode.

For example:

In weighing mode, a fully-loaded 15 kg capacity scale (GRADS = 3000, CNT BY = 5) would show 15.000 kg with a minimum display division of 0.005 kg.

In Test mode, the same fully-loaded scale would show 3000 with a minimum display division of 0.1.

## 6. Using the EDP Port

---

### In this section:

- Overview
- Simple Commands (No Response)
- Inquiry Commands (Requesting Status/Data)
- ID Reference Commands
- Commands to Read and Write to IDs

### Note:

*Commands intended for CW-80 Checkweigher address 0 are broadcast commands. All CW-80s are to interpret and act upon a particular command. No REPLY acknowledge character string is to be transmitted to indicate receipt of a command, since serial port bus contention will likely occur.*

### Overview

The EDP (electronic data processing) port allows you to transfer important weigh-process data to printers or computers.

The CW-80 Checkweigher uses either bidirectional RS-232 or simplex (output only) 20 mA current loop communications as its standard communications interface. All characters are standard ASCII characters.

Optionally, an RS-485 communications package is available to provide networking capability of up to 32 devices (i.e., CW-80s, printers, and computers). Each can be individually addressed.

By using special commands from either a terminal keyboard or a specially-designed computer program, you can manipulate Over/Under/Tare and Units values, call up current settings for Tare/Tolerance sets, and perform reporting functions. Also, you can use special commands to transmit weight data directly from the EDP port on demand.

When you send a command via the EDP port, the command must be in a specific format. Generally, you type the command on the remote keyboard and press **ENTER** or **RETURN** to send it (in the formats shown, [ ], etc.).

This section describes four different command categories for implementing CW-80 EDP (or serial) communications:

- Simple Commands (No Response)
- Inquiry Commands (Response)
- ID Reference Commands
- Read and Write Commands

With each command category in this chapter is a description of the related format.

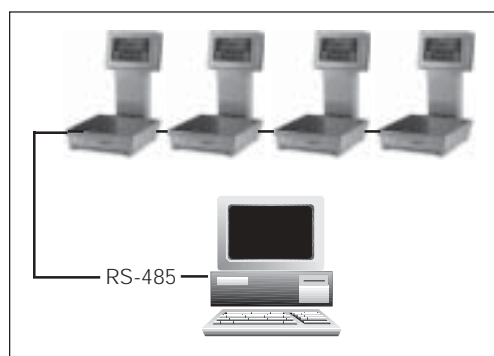

## Simple Commands (No Response)

### Note:

After the CW-80 receives a simple command, it responds with the character sequence [“\*”] [EOL], which means “OK”. This response verifies that the command was received. However, this response does not indicate that a requested action was completed. For example, the indicator will respond with [“\*”] [EOL] even if it disallows a ZERO function.

### Command Format Key:

[ ]	represents a separate field of information.
“ ”	represents literals which will appear as shown.

Simple Commands instruct the CW-80 to perform various functions. When you enter this type of EDP command, the CW-80 will **not** respond with data, but rather with an acknowledgement sequence (“\*[CR]”).

All available *simple commands*, response formats, and related syntax parameters are described in Table 6-1.

**Table 6-1.**

SIMPLE COMMANDS (NO RESPONSE—ACKNOWLEDGE ONLY)	
<i>Command Format:</i>	
[SOH][ADDR HIGH][ADDR LOW][COMMAND][CR]	
<i>Where:</i>	
[SOH]	is a single ASCII character (01 Hex) “Start of Header” that is a preamble to all bidirectional serial commands.
[ADDR HIGH]	is a single ASCII character for the most significant digit of the two digit Checkweigher Address.
[ADDR LOW]	is a single ASCII character for the least significant digit of the two digit Checkweigher Address.
[COMMAND]	is a command represented by one or more characters that instructs the CW-80 to perform a certain function. The list of available commands is detailed below.
[CR]	is a single ASCII character (1D Hex) “Carriage Return” used to signify the end of a complete serial command.
“Z”	(ZERO COMMAND)
“B”	(BUFFER ENABLE COMMAND)
“U”	(BUFFER DISABLE COMMAND)
“D”	(DATA BUFFER XMIT / NO CLEAR COMMAND)
“Y”	(DATA BUFFER XMIT AND CLEAR COMMAND)
“H”	(CLEAR BUFFER COMMAND)
“CT”	(CLEAR TARE COMMAND)
“CTG”	(CLEAR TARGET COMMAND)
“CO”	(CLEAR OVER COMMAND)
“CU”	(CLEAR UNDER COMMAND)
“Z”	(ZERO COMMAND)
	Requests that the CW-80 perform a Push-Button Zero function, if able. It must meet the criteria for Zero Band and Motion status to work. This is active when in the Gross or Net Weight display mode. The CW-80 acknowledges upon receipt of command with the Acknowledgment Character sequence, [“*”] [EOL], if enabled.

*continued...*

**Note:**

*The buffer is able to store in excess of 500 transactions in any of the Prt Out formats. A "BUFFER" error message will appear on the display for one second once the buffer has been filled to 90% of capacity. A "FULL" error message will appear on the display for one second once the buffer has been filled completely, and the next transaction will cause a loss of data. Data is discarded in a first-in first-out fashion.*

**Table 6-1. (continued)**

<b>SIMPLE COMMANDS</b>	
<b>"B"</b>	<p><b>(BUFFER ENABLE COMMAND)</b></p> <p>Requests that the CW-80 enable the transaction buffer. Once enabled, all data normally transmitted upon PRINT Key activation or Auto Print functions will be buffered. Data can then be made available from the buffer via serial command. This command will most often be used in multi-drop applications. The CW-80 acknowledges when successful with the Acknowledgement Character sequence, ["*"] [EOL], if enabled. This does not affect CW-80 "Power up" buffer status as defined in the Configuration Menus.</p>
<b>"U"</b>	<p><b>(BUFFER DISABLE COMMAND)</b></p> <p>Requests that the CW-80 disable the transaction buffer. Once disabled, all data normally transmitted upon PRINT Key activation or Auto Print functions will be sent out the serial port. The CW-80 acknowledges when successful with the Acknowledgement Character sequence, ["*"] [EOL] if enabled. This does not affect CW-80 "Power up" buffer status as defined in the Configuration Menus, however.</p>
<b>"D"</b>	<p><b>(DATA BUFFER XMIT / NO CLEAR COMMAND)</b></p> <p>Requests that the CW-80 transmit the contents of the transaction buffer. It, however, leaves the data in the transmit buffer intact, until cleared by either a "Y" or "H" command. No acknowledgement is made if transactions are in the buffer. Only the transactions are transmitted. If the transaction buffer is empty, the CW-80 acknowledges the command with a ["*"] [EOL] Acknowledgement Character sequence, if enabled.</p>
<b>"Y"</b>	<p><b>(DATA BUFFER XMIT AND CLEAR COMMAND)</b></p> <p>Requests that the CW-80 transmit the contents of the transaction buffer, and to clear the transaction buffer. No acknowledgement is made if transactions are in the buffer. Only the transactions are transmitted. If the transaction buffer is empty, the CW-80 acknowledges the command with a ["*"] [EOL] Acknowledgement Character sequence, if enabled. Only complete transactions are transmitted.</p>
<b>"H"</b>	<p><b>(CLEAR BUFFER COMMAND)</b></p> <p>Requests that the CW-80 clears the contents of its transaction buffer without transmitting the contents of the buffer. The CW-80 acknowledges when successful with the Acknowledgement Character sequence, ["*"] [EOL], if enabled.</p>

*continued...*

**Table 6-1. (continued)**

<b>SIMPLE COMMANDS</b>	
<b>“CT”</b>	<b>(CLEAR TARE COMMAND)</b>  This sequence requests the CW-80 to clear the current Tare value. The CW-80 acknowledges when successful with the Acknowledgement Character sequence, [“*”][EOL], if enabled. Note that the contents of the Tare register of the current ID are unaffected by this command.
<b>“CTG”</b>	<b>(CLEAR TARGET COMMAND)</b>  This sequence requests the CW-80 to clear the current Target value. The CW-80 acknowledges when successful with the Acknowledgement Character sequence, [“*”][EOL], if enabled. Note that the contents of the Target value of the current ID are unaffected by this command.
<b>“CO”</b>	<b>(CLEAR OVER COMMAND)</b>  This sequence requests the CW-80 to clear the current Over value. The CW-80 acknowledges when successful with the Acknowledgement Character sequence, [“*”][EOL], if enabled. Note that the contents of the Over value of the current ID are unaffected by this command.
<b>“CU”</b>	<b>(CLEAR UNDER COMMAND)</b>  This sequence requests the CW-80 to clear the current Under value. The CW-80 acknowledges when successful with the Acknowledgement Character sequence, [“*”][EOL], if enabled. Note that the contents of the Under value of the current ID are unaffected by this command.

## Inquiry Commands (Requesting Status/Data)

Inquiry Commands instruct the selected CW-80 to transmit weight data or the status of various current parameter values. When you enter this type of EDP command, the CW-80 will respond.

All available *inquiry commands*, response formats, and related syntax parameters are described in Table 6-2.

**Table 6-2.**

<b>INQUIRY COMMANDS (REQUESTING STATUS)</b>	
“XS”	(XMIT STATUS COMMAND)
“RT”	(RECALL TARE COMMAND)
“XTG”	(XMIT TARGET COMMAND)
“XO”	(XMIT OVER COMMAND)
“XU”	(XMIT UNDER COMMAND)
“XT”	(XMIT TARE COMMAND)
“X”	(XMIT DATA COMMAND)
“XW”	(XMIT WEIGHT DATA COMMAND)
“XC”	(XMIT CURRENT TOLERANCE STATUS)
“XTA”	(XMIT ALL TARES COMMAND)
“XTGA”	(XMIT ALL TARGETS COMMAND)
“XOA”	(XMIT ALL OVERS COMMAND)
“XUA”	(XMIT ALL UNDERS COMMAND)
 “XS” (XMIT STATUS COMMAND)  	
The “XS” command requests the CW-80 to transmit the current status.	
<i>CW-80 Response Format:</i>	
[STX][G/N][T][L/K/O/Z/G][M/S][O][O/A/U][EOL]	
<i>Where:</i>	
[STX]	is the one-ASCII character (02 Hex) for Start of Text.
[G/N]	is the one-character indication of current weight display mode, G for Gross Weight, N for Net Weight.
[T]	is the one-character indication of whether the scale is at or above a 1% of full scale threshold. A “T” for greater than or equal to 1% of full scale, and a space for less than 1% of full scale will be inserted at this position in the status response.
[L/K/O/Z/G]	is the one-character indication of the current displayed unit of measure:
	K for kilograms
	G for grams
	L for pounds
	O for ounces
	Z for pounds and ounces
<i>continued...</i>	

### Command Format Key:

[ ] represents a separate field of information.

“ ” represents literals which will appear as shown.

**Table 6-2. (continued)**

<b>INQUIRY COMMANDS (REQUESTING STATUS)</b>	
<b>[M/S]</b>	is one-character of status information: M for Motion, or scale is not in standstill S for in range, stable reading
<b>[O]</b>	is one-character of overload status information: O for scale overloaded.
<b>[SP]</b>	for scale in range.
<b>[O/A/U]</b>	is the one-character indication of OVER/ACCEPT/UNDER status for weight greater than or equal to the Over value: O for weight above or equal to the Over value. A for weight within the Accept range. U for weight below or equal to the Under value.
<b>[EOL]</b>	is either [CR] or [CR][LF], depending on serial port setting for End of Line Termination.
<b>“RT” (RECALL TARE COMMAND)</b>	
This sequence requests the CW-80 to transmit the current ID register number. The valid values are 0 – 299. There are 299 individual OVER/UNDER/TARE/UNITS register sets that can be randomly accessed.	
<i>Response Format:</i>	
<b>[STX][“T:”][nnn][EOL]</b>	
<i>Where:</i>	
<b>[STX]</b>	is the one-ASCII character (02 Hex) for Start of Text.
<b>[“T:”]</b>	is ASCII literal text for 54h, 3Ah.
<b>[nnn]</b>	is the three-ASCII character for the ID number. Example: [nnn] would be “025” for the 25th ID register.
<b>[EOL]</b>	is either [CR] or [CR][LF], depending on serial port setting for End of Line Termination.
<b>“XTG” (XMIT TARGET COMMAND)</b>	
This sequence requests the CW-80 to transmit the current target value associated with the current ID number.	
<i>Response Format:</i>	
<b>[STX][“G”][nnn][“:”][POL][DATA][SP][UNITS][EOL]</b>	
or	
<b>[STX][“G”][nn][“:”][POL][LBDATA][SP][lb][SP][OZDATA][oz][EOL]</b>	
<i>Where:</i>	
<b>[STX]</b>	is the one-ASCII character (02 Hex) for Start of Text.
<b>[“G”]</b>	is ASCII literal text (47 Hex).

*continued...*

**Command Format Key:**

- [ ] represents a separate field of information.
- “ ” represents literals which will appear as shown.

**Table 6-2. (continued)**

<b>INQUIRY COMMANDS (REQUESTING STATUS)</b>	
<b>[nnn]</b>	is the three-ASCII character for the ID number. Example: [nnn] would be "025" for the 25th ID register.
<b>[":"]</b>	is ASCII literal text (3A Hex).
<b>[POL]</b>	is the polarity or sign of the Target value space (20 Hex) for positive values. “-” (2D Hex) for negative values.
<b>[DATA]</b>	is a seven-character field with (including) decimal point for Target value data. Data is right justified, with leading zeros padded left with spaces (20 Hex).
<b>[LBDATA]</b>	is a one–three character field (dependent on scale capacity) with (including) decimal point for Target value data when used in lb and oz mode. Data is right justified, with leading zeros padded left with spaces (20 Hex).
<b>[OZDATA]</b>	is a two–five character field (dependent on scale capacity) with (including) decimal point for Target value data when used in lb and oz mode. Data is right justified, with leading zeros padded left with spaces (20 Hex).
<b>[SP]</b>	is the ASCII character for space (20 Hex).
<b>[UNITS]</b>	is the one–two character indication of the current unit of measure: kg for kilograms g for grams lb for pounds oz for ounces lb/oz use special format (See [LBDATA] and [OZDATA] above).
<b>[EOL]</b>	is either [CR] or [CR][LF], depending on serial port setting for End of Line Termination.
<b>“XO” (XMIT OVER COMMAND)</b>	
This sequence requests the CW-80 to transmit the current Over value associated with the current ID number.	
<i>Response Format:</i>	
<b>[STX][“O”][nnn][“:”][POL][DATA][SP][UNITS][EOL]</b>	
<i>continued...</i>	

**Command Format Key:**

- |     |   |
|-----|---|
| [ ] | represents a separate field of information.     |
| “ ” | represents literals which will appear as shown. |



**Table 6-2. (continued)**

<b>INQUIRY COMMANDS (REQUESTING STATUS)</b>	
<i>Where:</i>	
<b>[STX]</b>	is the one ASCII character (02 Hex) for Start of Text.
<b>[“O”]</b>	is ASCII literal text (4F Hex).
<b>[nnn]</b>	is three ASCII character for the ID number. Example: [nnn] would be “025” for the 25th ID register.
<b>[“:”]</b>	is ASCII literal text (3A Hex).
<b>[POL]</b>	is the polarity or sign of the Over value. space (20 Hex) for positive values. “-” (2D Hex) for negative values.
<b>[DATA]</b>	is a seven-character field with (including) decimal point for Over value data. Data is right justified, with leading zeros padded left with spaces (20 HEX).
<b>[SP]</b>	is the ASCII character for space (20 Hex).
<b>[UNITS]</b>	is the one–two character indication of the current unit of measure. kg for kilograms g for grams lb for pounds oz for ounces lb/oz use special format. See XTG command for full details.
<b>[EOL]</b>	is either [CR] or [CR][LF], depending on serial port setting for End of Line Termination.
<b>“XU” (XMIT UNDER COMMAND)</b>	
This sequence requests the CW-80 to transmit the current Under value associated with the current ID number.	
<i>Response Format:</i>	
<b>[STX][“U”][nnn][“:”][POL][DATA][SP][UNITS][EOL]</b>	
<i>Where:</i>	
<b>[STX]</b>	is the one-ASCII character (02 Hex) for Start of Text.
<b>[“U”]</b>	is ASCII literal text (55 Hex).
<b>[nnn]</b>	is the three-ASCII character for the ID number. Example: [nnn] would be “025” for the 25th ID register.
<i>continued...</i>	

**Command Format Key:**

[ ] represents a separate field of information.

“ ” represents literals which will appear as shown.

**Table 6-2. (continued)**

<b>INQUIRY COMMANDS (REQUESTING STATUS)</b>	
<b>[“:”]</b>	is ASCII literal text (3A Hex).
<b>[POL]</b>	is the polarity or sign of the Under value: space (20 Hex) for positive values. “-” (2D Hex) for negative values.
<b>[DATA]</b>	is a seven-character field with (including) decimal point for Under value data. Data is right justified, with leading zeros padded left with spaces (20 Hex).
<b>[UNITS]</b>	is the one–two character indication of the current unit of measure: kg for kilograms g for grams lb for pounds oz for ounces lb/oz use special format. See XTG command for full details.
<b>[EOL]</b>	is either [CR] or [CR][LF], depending on serial port setting for End of Line Termination.
<b>“XT” (XMIT TARE COMMAND)</b>	
This sequence requests the CW-80 to transmit the current Tare value associated with the current ID number.	
<i>Response Format:</i>	
<b>[STX][“T”][nnn][“:”][POL][DATA][SP][UNITS][EOL]</b>	
<i>Where:</i>	
<b>[STX]</b>	is the one-ASCII character (02 Hex) for Start of Text.
<b>[“T”]</b>	is ASCII literal text (54 Hex).
<b>[nnn]</b>	is the three-ASCII character for the ID number. Example: [nnn] would be “025” for the 25th ID register.
<b>[“:”]</b>	is ASCII literal text (3A Hex).
<b>[POL]</b>	is the polarity or sign of the Tare value: space (20 Hex) for positive values. “-” (2D Hex) for negative values.
<b>[DATA]</b>	is a seven-character field with (including) decimal point for Tare value data. Data is right justified, with leading zeros padded left with spaces (20 Hex).
<b>[SP]</b>	is the ASCII character for space (20 Hex).
<b>[UNITS]</b>	is the one–two character indication of the current unit of measure: kg for kilograms g for grams lb for pounds oz for ounces lb/oz use special format. See XTG command for full details.
<i>continued...</i>	

**Command Format Key:**

[ ] represents a separate field of information.

“ ” represents literals which will appear as shown.

**Table 6-2. (continued)**

<b>INQUIRY COMMANDS (REQUESTING STATUS)</b>	
<b>[EOL]</b>	is either [CR] or [CR][LF], depending on serial port setting for End of Line Termination.
<b>“X” (XMIT DATA COMMAND)</b>	
Requests that the CW-80 perform a simple XMIT out the serial port in the selected Prt Out format. No acknowledgement takes place, but the transmission is made, if possible.	
<b>“XW” (XMIT WEIGHT DATA COMMAND)</b>	
This sequence requests the CW-80 to transmit the current displayed weight reading only in the following format.	
<i>Response Format:</i>	
<b>[STX][POL][DATA][SP][UNITS][EOL]</b>	
<i>Where:</i>	
<b>[STX]</b>	is the one-ASCII character (02 Hex) for Start of Text.
<b>[POL]</b>	is the polarity or sign of the current displayed weight: space (20 Hex) for positive values. “-” (2D Hex) for negative values.
<b>[DATA]</b>	is a seven-character field with (including) decimal point for current displayed weight reading. Data is right justified, with leading zeros padded left with spaces (20 Hex).
<b>[SP]</b>	is the ASCII “SPACE” character (20 Hex).
<b>[UNITS]</b>	is the one–two character indication of the current unit of measure: kg for kilograms g for grams lb for pounds oz for ounces lb/oz use special format. See XTG command for full details.
<b>[EOL]</b>	is either [CR] or [CR][LF], depending on serial port setting for End of Line Termination.
<i>continued..</i>	

**Command Format Key:**

- [ ] represents a separate field of information.
- “ ” represents literals which will appear as shown.

**Table 6-2. (continued)**

<b>INQUIRY COMMANDS (REQUESTING STATUS)</b>	
<b>“XC” (XMIT CURRENT TOLERANCE STATUS)</b>	
This sequence requests the CW-80 to transmit the current tolerance annunciator activated in the following format.	
<i>Response Format:</i>	
<b>[STX][SP][O/A/U][EOL]</b>	
<i>Where:</i>	
<b>[STX]</b>	is the one-ASCII character (02 Hex) for Start of Text.
<b>[SP]</b>	is the ASCII “SPACE” character (20 Hex).
<b>[O/A/U]</b>	is a four-character field indicating current Tolerance annunciator activation status: “OVER” for OVER Tolerance annunciator activated “UNDR” for UNDER Tolerance annunciator activated “ACPT” for ACCEPT Tolerance annunciator activated
<b>[EOL]</b>	is either [CR] or [CR][LF], depending on serial port setting for End of Line Termination.
<b>“XTA” (XMIT ALL TARES COMMAND)</b>	
This sequence requests the CW-80 to transmit a list of all stored Tare values by ID number. Only the valid Tare values will be transmitted.	
<i>Response Format:</i>	
<b>[STX][“T”][001][“:”][POL][DATA][UNITS][EOL]</b>	
<b>[STX][“T”][002][“:”][POL][DATA][UNITS][EOL]</b>	
.	
.	
.	
<b>[STX][“T”][nnn][“:”][POL][DATA][SP][UNITS][EOL]</b>	
<i>Where:</i>	
<b>[STX]</b>	is the one-ASCII character (02 Hex) for Start of Text.
<b>[“T”]</b>	is ASCII literal text (54 Hex).
<b>[nnn]</b>	is the three-ASCII character for the ID number. Example: [nnn] would be “025” for the 25th ID register.
<i>continued..</i>	

**Command Format Key:**

[ ]	represents a separate field of information.
“ ”	represents literals which will appear as shown.

**Table 6-2. (continued)**

<b>INQUIRY COMMANDS (REQUESTING STATUS)</b>	
<b>[“:”]</b>	is ASCII literal text (3A Hex)
<b>[POL]</b>	is the polarity or sign of the Tare value: space (20 Hex) for positive values. “-” (2D Hex) for negative values.
<b>[DATA]</b>	is a seven-character field with (including) decimal point for Tare value data. Data is right justified, with leading zeros padded left with spaces (20 Hex).
<b>[SP]</b>	is the ASCII character for space (20 Hex).
<b>[UNITS]</b>	is the one–two character indication of the current unit of measure: kg for kilograms g for grams lb for pounds oz for ounces lb/oz use special format. See XTG command for full details.
<b>[EOL]</b>	is either [CR] or [CR][LF], depending on serial port setting for End of Line Termination.
<b>“XTGA” (XMIT ALL TARGETS COMMAND)</b>	
This sequence requests the CW-80 to transmit a list of all stored Target values by ID number. Only valid Targets will be transmitted.	
<i>Response Format:</i>	
	[STX][“G”][001][“:”][POL][DATA][UNITS][EOL] [STX][“G”][002][“:”][POL][DATA][UNITS][EOL] . . . [STX][“G”][nnn][“:”][POL][DATA][SP][UNITS][EOL]
<i>Where:</i>	
<b>[STX]</b>	is the one-ASCII character (02 Hex) for Start of Text.
<b>[“G”]</b>	is ASCII literal text (47 Hex).
<b>[nnn]</b>	is the three-ASCII character for the ID number. Examp1r: [nnn] would be “025” for the 25th ID register.
<i>continued..</i>	

**Command Format Key:**

[ ]	represents a separate field of information.
“ ”	represents literals which will appear as shown.

**Table 6-2. (continued)**

<b>INQUIRY COMMANDS (REQUESTING STATUS)</b>	
<b>[“:”]</b>	is ASCII literal text (3A Hex)
<b>[POL]</b>	is the polarity or sign of the Target value: space (20 Hex) for positive values. “-” (2D Hex) for negative values.
<b>[DATA]</b>	is a seven-character field with (including) decimal point for Target value data. Data is right justified, with leading zeros padded left with spaces (20 Hex).
<b>[SP]</b>	is the ASCII character for space (20 Hex).
<b>[UNITS]</b>	is the one–two character indication of the current unit of measure: kg for kilograms g for grams lb for pounds oz for ounces lb/oz use special format. See XTG command for full details.
<b>[EOL]</b>	is either [CR] or [CR][LF], depending on serial port setting for End of Line Termination.
<b>“XOA” (XMIT ALL OVERS COMMAND)</b>	
This sequence requests the CW-80 to transmit a list of all stored Over values by ID number. Only valid over values will be transmitted.	
<i>Response Format:</i>	
	[STX][“O”][001][“:”][POL][DATA][UNITS][EOL]
	[STX][“O”][002][“:”][POL][DATA][UNITS][EOL]
	.
	.
	.
	[STX][“O”][nnn][“:”][POL][DATA][SP][UNITS][EOL]
<i>Where:</i>	
<b>[STX]</b>	is the one-ASCII character (02 Hex) for Start of Text.
<b>[“O”]</b>	is ASCII literal text (4F Hex).
<b>[nnn]</b>	is the three-ASCII character for the ID number. Example: [nnn] would be “025” for the 25th ID register.
<b>[“:”]</b>	is ASCII literal text (3A Hex).
<b>[POL]</b>	is the polarity or sign of the Over value: space (20 Hex) for positive values. “-” (2D Hex) for negative values.
<b>[DATA]</b>	is a seven-character field with (including) decimal point for Over value data. Data is right justified, with leading zeros padded left with spaces (20 Hex).
<i>continued..</i>	

**Command Format Key:**

- |     |   |
|-----|---|
| [ ] | represents a separate field of information.     |
| “ ” | represents literals which will appear as shown. |



## ID Reference Commands

ID Reference Commands instruct the CW-80 to transmit various values associated with a particular ID number specified in the location field. Upon receipt of this type of EDP command, the CW-80 will respond with the requested information in a specific format. In some cases, it may respond with the sequence [“\*”][EOL] when the operation is completed.

All available *ID reference commands*, response formats, and related syntax parameters are described in Table 6-3.

**Table 6-3.**

### Command Format Key:

[ ]	represents a separate field of information.
“ ”	represents literals which will appear as shown.

ID REFERENCE COMMANDS	
<i>Format:</i>	
[SOH][ ADDR HIGH][ ADDR LOW][COMMAND][LOCATION][CR]	
<i>Where:</i>	
[SOH]	This is a single ASCII character (01 Hex) “Start of Header” that is a preamble to all bidirectional serial commands.
[ADDR HIGH]	This is a single ASCII character for the most significant digit of the two-digit CW-80 Address.
[ADDR LOW]	This is a single ASCII character for the least significant digit of the two-digit CW-80 Address.
[COMMAND]	This is a two character sequence for the command that instructs the CW-80 to perform a certain function. The list of available commands is detailed below.
[LOCATION]	This is a three-character field that specifies the location or ID number of the Over/Under/Tare/Units data to be inspected or altered.
[CR]	This is a single ASCII character (1D Hex) “Carriage Return” used to signify the end of a complete serial command.
“RT”	(RECALL TARE REGISTER COMMAND)
“XT”	(XMIT TARE COMMAND)
“XTG”	(XMIT TARGET COMMAND)
“XO”	(XMIT OVER COMMAND)
“XU”	(XMIT UNDER COMMAND)
“CT”	(CLEAR TARE COMMAND)
“CTG”	(CLEAR TARGET COMMAND)
“CO”	(CLEAR OVER COMMAND)
“CU”	(CLEAR UNDER COMMAND)
<i>continued...</i>	



**Table 6-3. (continued)**

<b>ID REFERENCE COMMANDS</b>	
<b>“RT” (RECALL TARE REGISTER COMMAND)</b>	
<p>This sequence requests the CW-80 to Recall the Over/Under/Tare/Units values associated with the ID number located in the Location character field, and make these new values the current operating Over/Under/Tare/Units values. The CW-80 acknowledges with a “*” (ASCII 2A Hex), when successful.</p>	
<b>“XT” (XMIT TARE COMMAND)</b>	
<p>This sequence requests the CW-80 to Transmit the tare value associated with the ID number located in the Location character field. It does not make this Tare value the current tare value. It is simply used for inspection. The CW-80 responds with the following format:</p>	
<i>Response Format:</i>	
<b>[STX][“T”][nnn][“:”][POL][DATA][SP][UNITS][EOL]</b>	
<i>Where:</i>	
<b>[STX]</b>	is the 1-ASCII character (02 Hex) for Start of Text.
<b>“T”</b>	is ASCII literal text (54 Hex).
<b>[nnn]</b>	is the 3-ASCII character for the ID number. ex.[nnn] would be “025” for the 25th ID register.
<b>“:”</b>	is ASCII literal text (3A Hex).
<b>[POL]</b>	is the polarity or sign of the Tare value: space (20 Hex) for positive values. “-” (2D Hex) for negative values.
<b>[DATA]</b>	is a 7-character field with (including) decimal point for Tare value data. Data is right justified, with leading zeros padded left with spaces (20 Hex).
<b>[SP]</b>	is the ASCII character for space (20 Hex).
<b>[UNITS]</b>	is the 1–2 character indication of the current unit of measure: <ul style="list-style-type: none"> <li>kg for kilograms</li> <li>g for grams</li> <li>lb for pounds</li> <li>oz for ounces</li> <li>lb/oz use special format</li> </ul>
<b>[EOL]</b>	is either [CR] or [CR][LF], depending on serial port setting for End of Line Termination.
<i>continued...</i>	

**Command Format Key:**

- [ ] represents a separate field of information.
- “ ” represents literals which will appear as shown.

**Table 6-3. (continued)**

**Command Format Key:**

- |     |   |
|-----|---|
| [ ] | represents a separate field of information.     |
| “ ” | represents literals which will appear as shown. |

<b>ID REFERENCE COMMANDS</b>	
<b>“XTG” (XMIT TARGET COMMAND)</b>	
<p>This sequence requests the CW-80 to Transmit the Target value associated with the ID number located in the Location character field. It does not make this Target value the current Target value. It is simply used for inspection. The CW-80 responds with the following format:</p> <p><i>Response Format:</i></p> <p style="text-align: center;">[STX][“G”][nnn][“:”][POL][DATA][SP][UNITS][EOL]</p> <p><i>Where:</i></p> <p><b>[STX]</b> is the 1 ASCII character (02 Hex) for Start of Text.</p> <p><b>[“G”]</b> is ASCII literal text (47 Hex).</p> <p><b>[nnn]</b> is the 3-ASCII character for the ID number. ex.[nnn] would be “025” for the 25th ID register.</p> <p><b>[“:”]</b> is ASCII literal text (3A Hex).</p> <p><b>[POL]</b> is the polarity or sign of the Target value: space (20 Hex) for positive values. “-” (2D Hex) for negative values.</p> <p><b>[DATA]</b> is a 7-character field with (including) decimal point for Target value data. Data is right justified, with leading zeros padded left with spaces (20 Hex).</p> <p><b>[SP]</b> is the ASCII character for space (20 Hex).</p> <p><b>[UNITS]</b> is the 1 – 2 character indication of the current unit of measure:</p> <ul style="list-style-type: none"> <li>kg for kilograms</li> <li>g for grams</li> <li>lb for pounds</li> <li>oz for ounces</li> <li>lb/oz use special format</li> </ul> <p><b>[EOL]</b> is either [CR] or [CR][LF], depending on serial port setting for End of Line Termination.</p>	
<b>“XO” (XMIT OVER COMMAND)</b>	
<p>This sequence requests the CW-80 to Transmit the Over value associated with the ID number located in the Location character field. It does not make this Over value the current Over value. It is simply used for inspection. The CW-80 responds with the following format:</p> <p><i>Response Format:</i></p> <p style="text-align: center;">[STX][“O”][nnn][“:”][POL][DATA][SP][UNITS][EOL]</p>	
<i>continued...</i>	

**Table 6-3. (continued)**

<b>ID REFERENCE COMMANDS</b>	
<i>Where:</i>	
<b>[STX]</b>	is the 1-ASCII character (02 Hex) for Start of Text.
<b>[“O”]</b>	is ASCII literal text (4F Hex).
<b>[nnn]</b>	is the 3-ASCII character for the ID number.ex.[nnn] would be “025” for the 25th ID register.
<b>[“:”]</b>	is ASCII literal text (3A Hex).
<b>[POL]</b>	is the polarity or sign of the Over value: space (20 Hex) for positive values. “-” (2D Hex) for negative values.
<b>[DATA]</b>	is a 7-character field with (including) decimal point for Over value data. Data is right justified, with leading zeros padded left with spaces (20 Hex).
<b>[SP]</b>	is the ASCII character for space (20 Hex).
<b>[UNITS]</b>	is the 1–2 character indication of the current unit of measure: kg for kilograms g for grams lb for pounds oz for ounces lb/oz use special format
<b>[EOL]</b>	is either [CR] or [CR][LF], depending on serial port setting for End of Line Termination.
<b>“XU” (XMIT UNDER COMMAND)</b>	
This sequence requests the CW-80 to Transmit the Under value associated with the ID number located in the Location character field. It does not make this Under value the current Under value. It is This sequence requests the CW-80 to Transmit the Under value associated with the ID number simply used for inspection. The CW-80 responds with the following format:	
<i>Response Format:</i>	
<b>[STX][“U”][nnn][“:”][POL][DATA][SP][UNITS][EOL]</b>	
<i>Where:</i>	
<b>[STX]</b>	is the 1 ASCII character (02 Hex) for Start of Text.
<b>[“U”]</b>	is ASCII literal text (55 Hex).
<b>[nnn]</b>	is 3-ASCII character for the ID number. ex. [nnn] would be “025” for the 25th ID register.
<b>[“:”]</b>	is ASCII literal text (3A Hex).
<b>[POL]</b>	is the polarity or sign of the Under value: space (20 Hex) for positive values. “-” (2D Hex) for negative values.
<b>[DATA]</b>	is a 7-character field with (including) decimal point for Under value data. Data is right justified, with leading zeros padded left with spaces (20 Hex).
<i>continued...</i>	

**Command Format Key:**

[ ] represents a separate field of information.
“ ” represents literals which will appear as shown.

**Table 6-3. (continued)**

<b>ID REFERENCE COMMANDS</b>	
<b>“RT”</b>	<b>(RECALL TARE REGISTER COMMAND)</b>
<b>“XT”</b>	<b>(XMIT TARE COMMAND)</b>
<b>“XTG”</b>	<b>(XMIT TARGET COMMAND)</b>
<b>“XO”</b>	<b>(XMIT OVER COMMAND)</b>
<b>[SP]</b>	is the ASCII character for space (20 Hex).
<b>[UNITS]</b>	is the 1–2 character indication of the current unit of measure: kg for kilograms g for grams lb for pounds oz for ounces lb/oz use special format
<b>[EOL]</b>	is either [CR] or [CR][LF], depending on serial port setting for End of Line Termination.
<b>“CT” (CLEAR TARE COMMAND)</b>	
This sequence requests the CW-80 to Clear the Tare value associated with the ID specified in the Location character field. The CW-80 acknowledges when successful with the Acknowledgement Character sequence [“*”][EOL] if enabled.	
<b>“CTG” (CLEAR TARGET COMMAND)</b>	
This sequence requests the CW-80 to Clear the Target value associated with the ID specified in the Location character field. The CW-80 acknowledges when successful with the Acknowledgement Character sequence [“*”][EOL] if enabled.	
<b>“CO” (CLEAR OVER COMMAND)</b>	
This sequence requests the CW-80 to Clear the Over value associated with the ID specified in the Location character field. The CW-80 acknowledges when successful with the Acknowledgement Character sequence [“*”][EOL] if enabled.	
<b>“CU” (CLEAR UNDER COMMAND)</b>	
This sequence requests the CW-80 to Clear the Under value associated with the ID specified in the Location character field. The CW-80 acknowledges when successful with the Acknowledgement Character sequence [“*”][EOL] if enabled.	

## Commands to Read and Write to IDs

One way the CW-80 is very different from the CW40 is in the area of ID Serial commands. The !I command is used to transmit a Tare/Tolerance set to a checkweigher, and have it store the contents in the desired ID# location. The ?I command is used to request that a checkweigher transmit the contents of a particular ID Register set from the serial port back to the host controller. All available read and write commands, response formats, and related syntax parameters are described in table 6-4.

**Table 6-4.**

### Command Format Key:

- [ ] represents a separate field of information.
- “ ” represents literals which will appear as shown.

<b>READ AND WRITE COMMANDS</b>	
<b>TO WRITE TO AN ID REGISTER SET:</b>	
<i>Response Format:</i>	
	<b>[SOH][Addr][!“!P”][ID#][“,”][Under Data][,][Over Data][,][Tare Data][,][Unit][CR]</b>
<i>Where:</i>	
<b>[SOH]</b>	This is a single ASCII character (01 Hex) “Start of Header” that is a preamble to all bidirectional serial commands.
<b>[Addr]</b>	This is a two character ASCII sequence 00-99 for the address of the Checkweigher that reads and reacts to the next command.
<b>[!“!P”]</b>	This is a two character sequence that instructs the checkweigher to store the associated Tare/Tolerance data in the designated ID#.
<b>[“,”]</b>	This is the ASCII Character 2C Hex.
<b>[ID#]</b>	This is a 3 character field that specifies the record number or location of the ID where the OVER/UNDER/TARE/UNITS data is to be stored.
<b>[Under Data]</b>	This is a 7 character field including a decimal point that represents the Under Value to be associated with this ID. The field must be in the same format as the displayed format for the Unit of measure associated with the ID record. All 7 characters must be sent and spaces may be substituted for leading zeros.
<b>[Over Data]</b>	This is a 7 character field including a decimal point that represents the Over Value to be associated with this ID. The field must be in the same format as the displayed format for the Unit of measure associated with the ID record. All 7 characters must be sent and spaces may be substituted for leading zeros.
<b>[Tare Data]</b>	This is a 7 character field including decimal point that represents the Tare Value to be associated with this ID. The field must be in the same format as the displayed format for the Unit of measure associated with the ID record. All 7 characters must be sent and spaces may be substituted for leading zeros.
<i>continued...</i>	

**Table 6-4. (continued)**

<b>READ AND WRITE COMMANDS</b>	
<b>[UNITS]</b>	<p>This is a single character field indicating the units of measure to be associated with all OVER/UNDER/TARE/UNITS values for the given ID number.</p> <p style="margin-left: 40px;">L     for pounds</p> <p style="margin-left: 40px;">K     for kilograms</p> <p style="margin-left: 40px;">G     for grams</p> <p style="margin-left: 40px;">O     for ounces</p> <p style="margin-left: 40px;">Z     for pounds and ounces</p>
<b>[CR]</b>	<p>This is a single ASCII character (1D Hex) “Carriage Return” used to signify the end of a complete serial command..</p>
<b>Note:</b>	
<p><i>The !I sequence requests that the checkweigher “STORE” the attached DATA to the desired ID record associated with the ID specified in the ID# field. An ID# must always be specified. Note: The entry of Tare/Tolerance parameters into IDs other than 000 do not immediately change the Checkweigher’s operational parameters. A subsequent RT command must be sent in order to make the newly entered parameters the current checkweigher parameters. The entry of Tare/Tolerance parameters into ID#000 immediately changes the Checkweigher’s current operational parameters, but ID#000 is not overwritten. It still contains the Default settings. A subsequent RT command to ID#000 would reset the Tare/Tolerance/Units settings back to the default parameters. The Checkweigher acknowledges with a [“*”][EOL] (ASCII 2A Hex), when successful, and a [“?”][EOL] (ASCII 3F Hex) if unsuccessful.</i></p>	
<b>Example:</b>	
<p><i>To enter the the following Tare/Tolerance values (Tare value=1.3 kg, Over value= 20.05 kg, Under value of 20.00 kg) into the register set of ID#45 of a Checkweigher with an Address of 36, which has been previously configured to have a 30kg x .01 kg capacity, send the following:</i></p>	
<p><b>[SOH]36!I045,0020.00,0020.05,0001.30,K[CR]</b></p>	
<b>TO READ THE CONTENTS OF AN ID REGISTER SET:</b>	
<i>Response Format:</i>	
<p><b>[SOH][Addr][“?P”][ID#][CR]</b></p>	
<i>Where:</i>	
<b>[SOH]</b>	<p>This is a single ASCII character (01 Hex) “Start of Header” that is a preamble to all bidirectional serial commands.</p> <p style="text-align: right;"><i>continued...</i></p>

**Table 6-4. (Continued)**

<b>READ AND WRITE COMMANDS</b>	
<b>[Addr]</b>	This is a two-character ASCII sequence 00-99 for the address of the Checkweigher that reads and reacts to the next command.
<b>[“?I”]</b>	This is a two-character sequence for the command that instructs the checkweigher to store the associated Tare/Tolerance data in the designated ID# .
<b>[ID#]</b>	This is a three-character field that specifies the record number or location of the ID where the OVER/UNDER/TARE/UNITS data is to be stored.
<b>[CR]</b>	This is a single ASCII character (1D Hex) “Carriage Return” used to signify the end of a complete serial command.
<p>The Checkweigher’s response to the ?I command is dependent on several things, but if the ID Register set addressed with the ?I command, then the Checkweigher will respond with the following format:</p> <p><i>Response Format:</i></p> <p style="text-align: center;"><b>[STX][ID#[“,”][Under Data][“,”][Over Data][“,”][Tare Data][“,”][Unit][EOL]</b></p> <p><i>Where:</i></p>	
<b>[STX]</b>	This is a single ASCII character (02 Hex) “Start of Text” that is a preamble to all bidirectional serial command responses
<b>[ID#]</b>	This is a three-character field that specifies the record number or location of the ID where the OVER/UNDER/TARE/UNITS data is to be stored.
<b>[“,”]</b>	This is the ASCII Character 2C Hex.
<b>[Under Data]</b>	This is an eight-character field including sign and decimal point that represents the Under Value associated with this ID. The field is in the same format as the displayed format for the Unit of measure associated with the ID record. All 8 characters are sent and spaces are substituted for leading zeros . A positive sign is transmitted as a space.
<b>[Over Data]</b>	This is an eight-character field including sign and decimal point that represents the Over Value associated with this ID. The field is in the same format as the displayed format for the Unit of measure associated with the ID record. All eight-characters are sent and spaces are substituted for leading zeros. A positive sign is transmitted as a space.
<b>[Tare Data]</b>	This is an eight-character field including sign and decimal point that represents the Tare Value associated with this ID. The field is in the same format as the displayed format for the Unit of measure associated with the ID record. All eight-characters are sent and spaces are substituted for leading zeros. A positive sign is transmitted as a space.
<i>continued...</i>	

**Command Format Key:**

- [ ] represents a separate field of information.
- “ ” represents literals which will appear as shown.

**Table 6-4. (continued)**

<b>READ AND WRITE COMMANDS</b>	
<b>[ UNITS ]</b>	<p>This is a single character field indicating the units of measure to be associated with all OVER/UNDER/TARE/UNITS values for the given ID number.</p> <p style="margin-left: 40px;">L     for pounds</p> <p style="margin-left: 40px;">K     for kilograms</p> <p style="margin-left: 40px;">G     for grams</p> <p style="margin-left: 40px;">O     for ounces</p> <p style="margin-left: 40px;">Z     for pounds and ounces</p>
<b>[EOL]</b>	<p>This is a ASCII End of Line character sequence “CR” or “CR/LF” as determined in the Serial Menu at Setup.</p>
<b>Note:</b>	
<p><i>The ?I sequence requests that the checkweigher “READ” the contents of the desired ID record associated with the ID specified in the ID# field, and transmit the content of the record out the serial port. The Checkweigher responds with the appropriate data if available otherwise it will send back the “Empty” response to indicate that the ID has not been previously stored.</i></p>	
<b>THE “EMPTY” RESPONSE IS IN THE FOLLOWING FORMAT:</b>	
<p><i>Response Format:</i></p> <p style="text-align: center;"><b>[STX][ID#][:][sp][“empty”][EOL]</b></p>	
<i>Where:</i>	
<b>[STX]</b>	<p>This is a single ASCII character (02 Hex) “Start of Text” that is a preamble to all bidirectional serial command responses.</p>
<b>[ID#]</b>	<p>This is a 3 character field that specifies the record number or location of the ID where the OVER/UNDER/TARE/UNITS data is to be stored.</p>
<b>[“:”]</b>	<p>This is the ASCII Character 3A Hex.</p>
<b>[sp]</b>	<p>This is the ASCII Character 20 Hex.</p>
<b>[“empty”]</b>	<p>This is an the ASCII literal string, excluding the “” marks.</p>
<b>[EOL]</b>	<p>This is a ASCII End of Line character sequence “CR” or “CR/LF” as determined in the Serial Menu at Setup.</p>
<b>Example:</b>	
<p><i>To request the Tare/Tolerance values from the register set of ID#16 of a Checkweigher with an Address of 85, which has been previously configured to have a 30kg x .01 kg capacity, send the following:</i></p>	
<p><b>[SOH]85?I016[CR]</b></p>	

**Command Format Key:**

- [ ] represents a separate field of information.
- “ ” represents literals which will appear as shown.



# 7. Advanced Features

**In this section:**

- Bar Graph
- Print Formats

## Bar Graph

The Bar Graph is a programmable 5-segment, 7-range LED that gives you a quick visual method of determining if a container is too heavy (Over), too light (Under), or in a correct range (ACCEPT). The functions of the 5 LEDs (or segments) are described in the following paragraphs.

### Red Segments (2)

The *red* segments (Figure 7-1) indicates an Under weight value. Any illuminated red segment(s) indicate that the container weighs less than the *lowest* acceptable value. There are three levels of Under weight readings. The outer red segment lit indicates that the weight is greatly below the acceptable weight band (see Figure 7-2). Both red segments lit indicates moderately under. The inner red segment lit indicates that the container weight is slightly under.

**Figure 7-1.**  
Bar graph segments

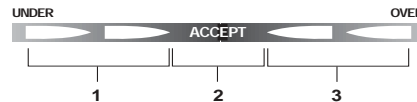

**Figure 7-1 Key**

- 1 .. Red Segments — under
- 2 .. Green Segment — accept
- 3 .. Amber Segments — over

**Figure 7-2.**  
Interpreting bar graph LED ranges

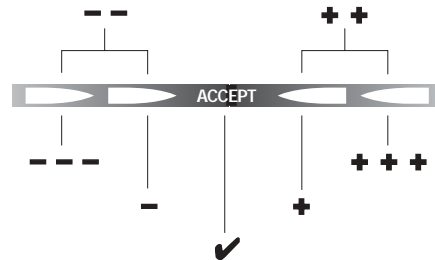

**Figure 7-2 Key**

- ... greatly under when outer arrow is lit
- .... moderately under when both are lit
- ..... slightly under when inner arrow is lit
- ✓..... (target) acceptable weight when lit
- + ..... slightly over when inner arrow is lit
- ++ .. moderately over when both are lit
- +++ greatly over when outer arrow is lit

### **Green Segment (1)**

The *green* segment (Figure 7-1) indicates an Accept value. When illuminated, the green segment light indicates that the container weight is within the actual *acceptable* band of weight limits (Figure 7-2).

### **Amber Segments (2)**

The *amber* segment (Figure 7-1) indicates an Over weight value. When illuminated, the amber segment(s) indicate that the container weight is more than the *highest* acceptable weight value. There are 3 levels of Over weight readings. The leftmost amber segment is used to indicate that the container weight is slightly over the acceptable weight band (Figure 7-2); the rightmost amber segment is used to indicate that the container weight is greatly above the acceptable weight band. Illuminating both amber segments indicates moderately overweight.

### **Setting Bar Graph Segments**

#### **Setting Weight Bar Graph Values: Ov 1, Un 1**

The ACCEPT band tolerances are set using weight values. Depending on the operating mode chosen, these values can be set by the installer in the Configuration mode, or can be set by the operator in Normal Weighing mode. When the weight on the scale just exceeds the ACCEPT band by 1 display division, the first amber segment lights. This level is set as Ov 1, or slightly over. When the weight on the scale is under the ACCEPT band by 1 display division, the first red segment lights. This level is set as UN 1, or slightly under. See Section 5, *Operating Modes*, for information on setting Ov 1 and UN 1 values.

#### **Setting Graduation Bar Graph Values: Ov 1-2, Ov 2, Un 1-2, Un 2**

The other bar graph settings can be set only in the Configuration mode, and are set using graduation (dd) values.

Moderately under (both red segments) is set as UN 1-2.

Greatly under (leftmost red segment) is set as UN 2.

Moderately over (both amber segments) is set as Ov 1-2.

Greatly over (rightmost amber segment) is set as Ov 2.

#### **Calculating Tolerance Values in Graduations**

To find the graduation value for a desired tolerance (where tolerance is a weight value), use the following formula:

$$\text{Tolerance} \div \text{dd} = \text{graduation}$$

Example: CW-80 with 6 lb x .002 display divisions in TARGET mode

Assume the desired tolerance for the product will be .01 lb

To find .01 lb expressed in graduations, divide .01 lb by .002 lb/grad

$$.01 \text{ lb} \div .002 \text{ lb/grad} = 5 \text{ graduations}$$

Therefore, to set the CW-80 so that Un 1, Un1-2, and Un 2 light at .01 intervals, parameters should be set to 5.

Because these values are cumulative, the first red segment (Un 1) will light at .01 lb under target, both red segments (Un 1-2) at .02 lb, and the leftmost red segment (Un 2) at .03 lb.

## Print Formats

When the **PRINT** key is pressed or when an Auto-Print occurs, the printout parameter (PR OUT) allows you to select a specific print format. There are four possible print formats available: TOL, SSF, CCC, and LFT.

You can also use the EDP port to send a print command in a selected format. Each command is represented by a specific serial format. Tables 7-1 through 7-4 describe the syntax and related parameters for each of the possible print formats. Sample printouts are shown in the left margin by each table.

**Table 7-1.**

### TOL Sample Print Outs

*TOL Gross Accept (lb):*  
5.230 LB GRA

*TOL Net Over (lb):*  
5.885 LB NTO

<b>TOL (tolerance) output format</b>	
<b>Units = kg, g, lb, oz</b> (see following page for <b>lb and oz</b> units print format)	
<i>Print Format:</i>	
<b>&lt;STX&gt;[POL][DATA]&lt;SP&gt;[KG/G/LB/OZ]&lt;SP&gt;[GR/NT][O/U][ST]&lt;EOL&gt;</b>	
<i>Where:</i>	
<b>&lt;STX&gt;</b>	is the ASCII "START OF TEXT" character (02 Hex).
<b>[POL]</b>	is the polarity indicator, 1 single character: ASCII 20 Hex (space) if a positive weight reading ASCII 2D Hex (minus sign) if negative weight
<b>[DATA]</b>	is a 7-character field with (including) decimal point for weight data. Data is right justified, with leading zeros padded left with spaces (20 Hex).
<b>&lt;SP&gt;</b>	is the ASCII "SPACE" character (20 Hex).
<b>[KG/G/LB/OZ]</b>	is the 1 – 2 character indication of the current unit of measure: KG for kilograms G for grams LB for pounds OZ for ounces
<b>[GR/NT]</b>	is the 2-character indication of current weighing mode: GR for gross weights NT for net weights
<b>[O/A/U]</b>	is the 1-character indication of Over/Accept/Under status: O if Over LED is illuminated. A if Accept LED is illuminated. U if Under LED is illuminated.
<i>continued</i>	

**Table 7-1. (continued)**

<b>TOL (tolerance) output format</b>	
<b>[ST]</b>	is a 1-character field for CW-80 status transmitted during continuous (PFUNCT=CONT) transmit mode only: M for Motion status, scale is not at standstill. R for Overload, out of range indication. <sp> ASCII (20 Hex) for Standstill, in range reading.
<b>&lt;EOL&gt;</b>	is either <CR> or <CR><LF>, depending on serial port setting for End of Line Termination.
<b>Units = lb and oz</b>	
<i>Print Format:</i>	
<b>&lt;STX&gt;[POL][DATALB]&lt;SP&gt;[LB]&lt;SP&gt;[DATAOZ]&lt;SP&gt;[OZ]&lt;SP&gt;  [GR/NT][O/A/U][ST]&lt;EOL&gt;</b>	
<i>Where:</i>	
<b>&lt;STX&gt;</b>	is the ASCII "START OF TEXT" character (02 Hex).
<b>[POL]</b>	is the polarity indicator, 1 single character: ASCII 20H (space) if positive weight reading ASCII 2DH (minus sign) if negative weight reading
<b>[DATALB]</b>	1- to 3-character field (dependent on scale capacity) for pound weight in lb and oz mode. Leading 0's to be transmitted as spaces (20 Hex).
<b>[DATAOZ]</b>	2- to 5-character field (dependent on scale capacity) including decimal point for ounce weight in lb and oz weighing mode. Data is right justified, with leading zeros padded with spaces.
<b>&lt;SP&gt;</b>	is the ASCII "SPACE" character (20 Hex).
<b>[GR/NT]</b>	is the 2-character indication of current weighing mode: GR for gross weights NT for net weights
<b>[O/A/U]</b>	is the 1-character indication of Over/Accept/Under status: O if Over LED is illuminated. A if Accept LED is illuminated. U if Under LED is illuminated.
<b>[ST]</b>	is a 1-character field for CW-80 status transmitted during continuous (PFUNCT=CONT) transmit mode only: M for Motion status, scale is not at standstill R for Overload, out of range indication <sp> ASCII (20 Hex) for Standstill, in range reading
<b>&lt;EOL&gt;</b>	is either <CR> or <CR><LF>, depending on serial port setting for End of Line Termination

**TOL Sample Print Outs**

*TOL Gross Accept (lb and oz):*

5 LB 2.10 OZ GRA

*TOL Net Over (lb and oz):*

5 LB 4.18 OZ NTO

**Table 7-2.**

**SSF Sample Print Outs**

*SSF Gross Accept:*

1.690LA

*SSF Net Accept:*

1.490LA

*SSF Gross Over:*

1.690LO

*SSF Net Over:*

1.490LO

<b>SSF (short standard format) output format</b>	
<b>Short Standard Format (not for lb and oz units of measure)</b>	
<i>Print Format:</i>	
<b>[POL][DATA][L/K/O/G][O/A/U]&lt;EOL&gt;</b>	
<i>Where:</i>	
<b>[POL]</b>	is the 1-character polarity indicator ASCII 20H (space) if positive weight reading. ASCII 2DH (minus sign) if negative weight reading.
<b>[DATA]</b>	is a 7-character field with (including) decimal point for weight data. Data is right justified, with leading zeros padded left with spaces (20 Hex).
<b>[L/K/O/G]</b>	is the 1-character indication of the current unit of measure: K for kilograms G for grams L for pounds O for ounces
<b>[O/A/U]</b>	is the 1-character indication of Over/Accept/Under status: O if Over LED is illuminated. A if Accept LED is illuminated. U if Under LED is illuminated.
<b>&lt;EOL&gt;</b>	is either <CR> or <CR><LF>, depending on serial port setting for End of Line Termination.

## CCC Sample Print Outs

CCC Non-continuous Gross:

1.690 LB GR

CCC Non-continuous Net:

1.490 LB NT

CCC Continuous Gross:

1.690LG

CCC Continuous Net:

1.490LN

**Table 7-3.**

CCC (consolidated controls) output format	
<b>Non-continuous or continuous transmission</b>	
<i>Print Formats:</i>	
<b>Non-continuous</b> —[STX][POL][DATA]<SP>[LB/KG/OZ]<SP>[GR/NT]<EOL>	
<b>Continuous</b> — [STX][POL][DATA][L/K/O][G/N][ST]<EOL>	
<i>Where:</i>	
<STX>	is the ASCII “START OF TEXT” character (02 Hex).
[POL]	is the polarity indicator, 1 single character: ASCII 20H (space) if positive weight reading. ASCII 2DH (minus sign) if negative weight reading.
[DATA]	is a 7-character field including decimal point for weight data. Data is right justified, with leading zeros padded left with spaces (20 Hex).
[LB/KG/OZ/G]	is the 1- to 2-character indication of the current unit of measure (for any PMODE setting except CNT): KG            for kilograms G             for grams LB            for pounds OZ            for ounces <SP>         for lb and oz
[L/K/O/G]	is the 1-character indication of the current unit of measure (for PMODE setting of CNT): K            for kilograms L            for pounds O            for ounces G            for grams <SP>        for lb and oz
[GR/NT]	is the 2-character indication of weight type (for any PMODE setting except CNT): GR    for Gross Weight information. NT    for Net Weight information.
[G/N]	is the 1-character indication of weight type (for PMODE setting of CNT): G    for Gross Weight information. N    for Net Weight information.
[ST]	is 1-character of status information: M    for Motion, or scale is not in Standstill. O    for scale Out of range, overloaded or underloaded. <SP> for in range, stable reading.
<EOL>	is either <CR> or <CR><LF>, depending on serial port setting for End of Line Termination.

## LFT/OIML Sample Print Outs

*LFT or OIML PTT tare mode with tare entered:*

4.690 LB G  
1.000 LB T  
3.690 LB N

*LFT or OIML PTT tare mode with no tare entered:*

4.690 LB G

*OIML SET tare mode with tare entered:*

4.690 LB G  
1.000 LB PT  
3.690 LB N

*OIML SET tare mode with no tare entered:*

4.690 LB G

### NOTE:

*Sleep mode must be set to OFF for any legal-for-trade application.*

**Table 7-4.**

LFT (Legal For Trade) and OIML output formats	
<b>Legal For Trade Format</b>	
<i>Print Formats:</i>	
[STX][POL][DATA]<SP>[LB/KG/OZ/G]<SP>[G]<EOL>	
[STX][POL][DATA]<SP>[LB/KG/OZ/G]<SP>[T/PT]<EOL>	
[STX][POL][DATA]<SP>[LB/KG/OZ/G]<SP>[N]<EOL>	
<i>Where:</i>	
<STX>	is the ASCII "START OF TEXT" character (02 Hex).
[POL]	is the polarity indicator, 1 single character: ASCII 20H (space) if positive weight reading. ASCII 2DH (minus sign) if negative weight reading.
[DATA]	is a 7-character field including decimal point for weight data. Data is right justified, with leading zeros padded left with spaces (20 Hex).
<SP>	is the ASCII "SPACE" character (20 Hex).
[LB/KG/OZ/G]	is the 1- to 2-character indication of the current unit of measure:
	KG            for kilograms
	G             for grams
	LB            for pounds
	OZ            for ounces
	<SP>         for lb and oz
[G]	is the indication for Gross Weight information.
[T/PT]	is the indication for Tare Weight information: T     for LFT and OIML PTT tare mode PT    for OIML SET tare mode
[N]	is the indication for Net Weight information.
<EOL>	is either <CR> or <CR><LF>, depending on serial port setting for End of Line Termination.



















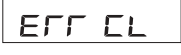

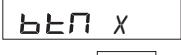
## 8. Maintenance and Troubleshooting

### Display Error Codes

#### In this section:

- Display Error Codes
- Troubleshooting Table
- Main Board/Display Replacement
- Load Cell Replacement

Table 8-1

Display error codes		
Display	Condition	Description
	OVERLOAD	Weight on scale is greater than calibrated capacity range.
	UNDERLOAD	Displayed weight is less than calibrated capacity range.
	ID ILLEGAL	ID number 0 cannot be stored. ID number must be a positive integer.
	NO CALIB.	Configuration settings relating to scale capacity, divisions, grads, or decimal pt. have been changed. Recalibrate scale using current settings.
	NO TOLERANCE	No tolerances have been entered for the displayed ID register.
	BUFFER FILLING.	Buffer 90% full.
	BUFFER FULL	Buffer 100% full.
	FAIL SIGNAL	No load cell signal present.
	DATA OUTPUT ERROR	Cannot display lb/oz data in 6 display digits.
	CALIBRATION ERROR	CAL SP value must be greater than 20% of full scale.
	LOW SIGNAL ERROR	Less than 0.3 $\mu$ V/grad signal is present.
	KEYPAD BUTTON ERROR	Keypad button X is not producing a signal.
		Keypad button 0 = target error.
		Keypad button 1 = print error.
		Keypad button 2 = zero error.
		Keypad button 3 = over error.
		Keypad button 4 = ID error.
		Keypad button 5 = tare error.
		Keypad button 6 = units error.
		Keypad button 7 = under error.
	NO UNITS	EEPROM checksum failure. CW-80 has defaulted to original units.
	ID ERROR	EEPROM write failure. Unable to write to ID selected.



## Troubleshooting Table

Table 8-2.

<b>Hardware troubleshooting</b>		
Symptom	Probable cause	Remedy
<i>No display</i>	Power disconnected	Connect power
	Cable cut or disconnected	Repair cable
	Signal leads incorrectly wired at indicator	Connect according to manual
<i>Display stays at zero</i>	Incorrect load cell cable connections	Connect according to manual
	Indicator faulty	Service indicator
<i>Erratic weight display</i>	Vibration near scale	Remove source of vibration, or adjust digital averaging of indicator to minimize erratic display
	Scale not level	Level scale
	Water damage to load cell or cable	Replace load cell
	Indicator faulty	Service indicator
	Loose load cell screws	Tighten to correct torque
	Faulty load cell	Test and replace if necessary
<i>Consistently low weight</i>	Indicator not properly adjusted to zero	Zero indicator correctly
	Scale deck cover binding	Obtain adequate clearance
	Overload stops set too high	Reset stops
	Indicator not calibrated for scale	Calibrate indicator
	Load cell faulty	Test and replace if necessary

 **Warning**

*Repair procedures requiring disassembly of the indicator enclosure carry the risk of electric shock to inexperienced personnel. Procedures requiring entry of the enclosure are to be performed by qualified service personnel only!*

## Main Board/Display Replacement

### Warning

There is no ON/OFF switch on the CW-80. Before beginning, be sure the CW-80 power cord is removed from the wall power receptacle. Disconnect battery if unit is so equipped.

### Caution

Static electricity may cause loss of stored information in the new main board, as well as physical damage to board components. Use a personal grounding device like a wrist strap to prevent static electricity charges jumping to the device and damaging the main board.

The steps below show you how to replace the CW-80 main board/display. The procedure involves removing the power board and main board/display to allow installation of the new board. Before you begin:

- Turn off the CW-80 power.
- Disconnect power cord from wall receptacle and battery backup.
- Establish a personal ground system, like a wrist strap, to prevent static electricity discharges to a device.
- At the rear of the CW-80 head, remove the 10 phillips-head screws that hold the back plate to the head.

### Removal

#### A. To remove the power board:

1. Disconnect ribbon cable that connects J1 (10-pin connector on the power supply board) to the main board. See Figure 8-1.
2. Remove AC power wires from main board studs. The hot wire to AC-1 is brown, and the neutral wire to AC-2 is blue. Grasp each wire's spade connector and pull up to remove from studs. Do not pull on the wires to disconnect, as the spade connectors will tear loose from the wires.
3. Remove the 4 phillips-head screws and washers from corners of power board and set aside.
4. Carefully lift power board from the main board/display standoffs and set aside.

**Figure 8-1.**  
**Power supply board**  
**(component side)**

### Caution

When changing fuse F1 or F2, replace only with the same type and rating of fuse to prevent risk of fire. See page 9-2 for fuse specifications.

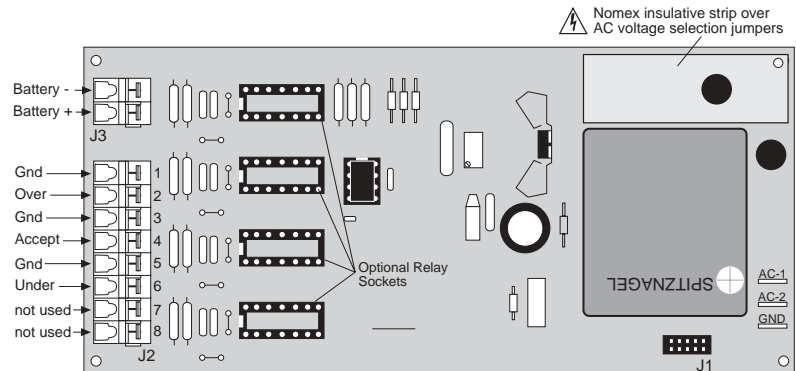

#### B. To remove the main board/display:

1. Remove the 10-pin display ribbon cable from the main board. See Figure 8-2 (1) on following page.
2. Remove the black, red, green, white, and yellow wires from the load cell terminal block (-EX, -S1, +S1, +EX, and SH1 respectively). See Figure 8-2 (2). To release each wire, use a small narrow-tip screwdriver to press the plastic lever down while pulling the wire up.

**Figure 8-2.**  
**Main CPU board**

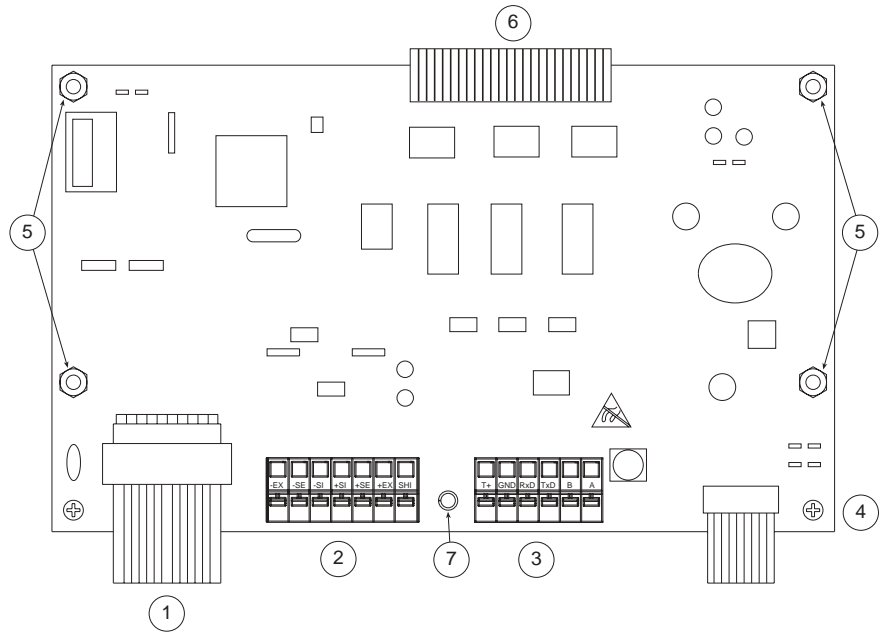

3. If serial communications are used, disconnect those wires from the serial communications terminal (3).
4. Using a hex-head socket wrench, remove the 4 standoffs (5).
5. Remove the two phillips screws (4) from the remaining corners.
6. As the main board and display are joined together by a soldered ribbon cable (6), gently lift both boards up away from the head and set aside.
7. Remove the white, plastic board support (7) from the edge of the main board. Keep nearby, as you will need it for the first installation step.

### Installation

To install the new main board:

1. Replace plastic board support at edge of main board.
2. Reverse the above steps used for removing the board.
3. Verify that all wire terminals correctly match the labeled connections.
4. Replace the back plate by tightening the 10 screws in the alternating pattern shown at left. Torque screws to a final value of 15 in/lbs.

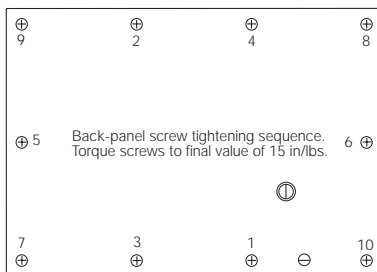

## Load Cell Replacement

### For 10"x10" and 12"x12" Scales (Capacities 6 - 60 lb.):

1. Unplug AC power from indicator, remove rear cover from indicator head (10 screws), and disconnect load cell cable from indicator's terminal connection strip.
2. Lift off scale top cover. Locate two upper load cell screws. Use 7/16" wrench to unscrew and remove those two load cell screws. Do not remove four spring-loaded screws that attach load plate to spider assembly. Lift off load plate/spider assembly as a unit. Remove spacer between load plate and load cell and set it aside.
3. Turn scale over and back off Overload Protection Screw one complete turn. Completely unscrew and remove the Lift up Protection Screw.
4. Use 7/16" wrench to unscrew and remove two lower load cell screws. The load cell and cable can now be removed from scale. Do not lose shim beneath load cell.

**Figure 8-3.**  
**10" and 12" Checkweigher base**  
**in 6-60 lb capacities**

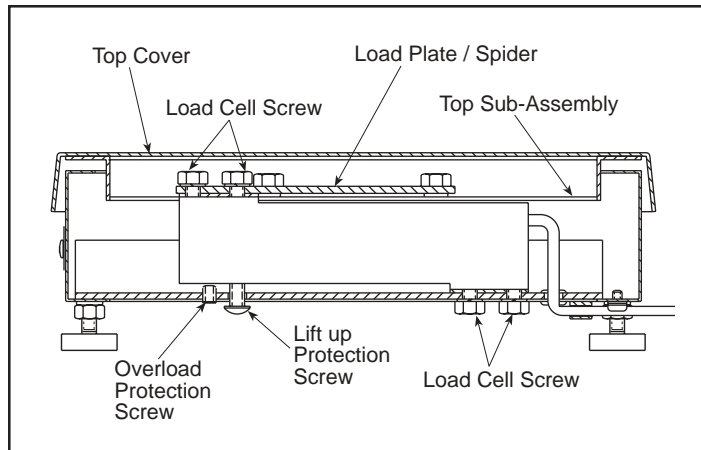

5. Thread cable of replacement load cell through rubber grommet. Position load cell on shim and screw in two lower load cell screws. Torque to 80 in. lbs.
6. Replace Lift up Protection Screw by screwing it in until it lightly bottoms, then back it off 1/4 turn.
7. Turn scale right side up. Position spacer on load cell, then place load plate/spider unit into position. Screw in two upper load cell screws. Torque to 80 in/lbs.
8. Using an accurate caliper, check compressed spring length on four overload springs shown in Figure 8-4. If necessary, adjust length to specifications in Table 8-3. Replace top cover and re-level scale.
9. Connect load cell cable to correct pins on indicator terminal strip. See Figure 2-2 in Installation section.
10. Tighten cord grip where cable enters indicator head.
11. Replace the back plate by tightening the 10 screws in the alternating pattern shown at left. Torque screws to a final value of 15 in/lbs.

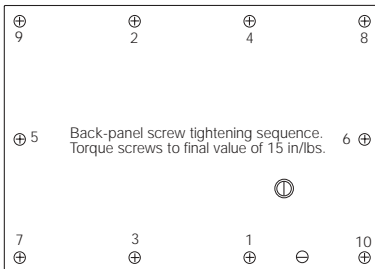

12. Recalibrate scale according to *Calibration* section of this manual.
13. Adjust Overload Protection Screw on bottom of scale by loading scale to 125% capacity. Place this weight on top cover, centered on platform. With appropriate size hex wrench, screw in Overload Protection Screw until it touches load cell, then back it off 1/6 turn. Recheck calibration.

**Table 8-3.**

SCALE MODEL	SPRING LENGTH "H"
Model 10 x 10 - 6 LB	1.00"
Model 10 x 10 - 10 LB	.94"
Model 10 x 10 - 15 LB	1.04"
Model 10 x 10 - 30 LB	1.43"
Model 12 x 12 - 30 LB	1.43"
Model 12 x 12 - 60 LB	.93"

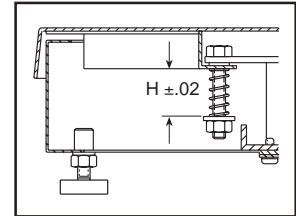
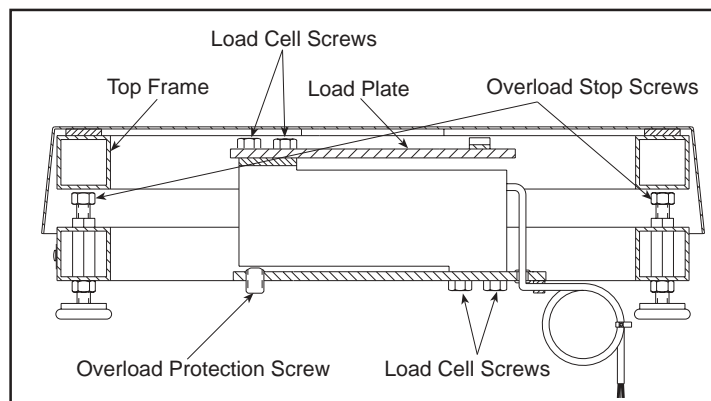

**Figure 8-4.**  
Adjusting spring height on 10"  
and 12" Checkweighers

**For 12"x12", 18"x18" and 24"x24" Scales (Capacities 100 - 1000 lb.):**

1. Unplug AC power from indicator, remove rear cover from indicator head (10 screws), and disconnect load cell cable from indicator's terminal strip.

**Figure 8-5**  
12", 18", and 24"  
Checkweigher base  
in 100 - 1,000 lb



2. Lift off scale top cover. Locate upper load cell screws. Depending on model of scale, there will be either two or four upper load cell screws. Unscrew and remove those load cell screws. Lift off top spider. Remove spacer plate and set it aside.
3. Loosen locking nuts on four Overload Stop Screws and turn each screw in one turn to provide ample clearance for new load cell when it is attached. Turn scale over and back off Overload Protection Screw one complete turn to provide clearance.
4. Unscrew and remove lower load cell screws. Depending on model of scale, there will be either two or four lower load cell screws. Remove bottom shim beneath load cell and set it aside. The load cell and cable can now be removed from scale.

5. Thread cable of replacement load cell through rubber grommet. Position bottom shim directly beneath load cell and screw in lower load cell screws. Torque to 120 in. lbs for 18" x 18" and 24" x 24" scales.
6. Turn scale right side up. Position spacer plate on load cell, then place the top spider into position. Screw in four upper load cell screws. Torque to 120 in. lbs for 18" x 18" and 24" x 24" scales.
7. Connect load cell cable to correct pins on indicator terminal strip. See Figure 2-2 in Installation section.
8. Tighten cord grip where cable enters indicator head.
9. Reattach rear cover by tightening screws in an alternating pattern to a final torque value of 15 in/lbs.
10. Recalibrate scale according to Calibration section of this manual.
11. Adjust Overload Protection Screw on bottom of scale by loading scale to 125% capacity. Place this weight on top cover, centered on platform. With appropriate size hex wrench, screw in Overload Protection Screw until it touches load cell, then back it off 1/6 turn. Recheck calibration.
12. To reset corner Overload Stop Screws, load top spider over one corner with 55%-60% of scale capacity. Adjust screw under that corner to just touch top frame, then tighten locking nut if one is used. Repeat for each corner. Replace top cover and re-level scale if necessary.

## 9. Appendix

### In this section:

- Specifications
- Assembly Drawings
- Replacement Parts List
- ASCII Character Set
- Software Revision History
- Limited Warranty

### Specifications





Analog Specifications	
Measurement Rate	25 updates/second
System Linearity	0.01% of F.S.
Zero Stability	100 nV/°C maximum
Span Stability	3 ppm/°C maximum
AZM (Zero Track)	Off, ± 0.5, 1, 2 or 3 dd
Zero Band	±2% or 100% F.S.
Motion Band	Off, 0.5, 1, 2, 3, 5, 10 dd
Calibration Method	Software
Excitation Voltage	10 ± 0.5 V DC, maximum 4 - 350 Ω load cells
Sense Amplifier	Differential amplifier with 6-wire sensing
RFI Protection	Signal, excitation and sense lines protection 3 V/m for 100 kHz to 1 GHz, ≤1 μV susceptibility
Digital Specifications	
Digital Filter	Software selectable: 1, 2, 4, 8, 16, 32, 64, 128
Digital Outputs	3 optional 5 VDC TTL-level digital outputs to indicate Over, Under, and Accept status. Optional relays available for outputs: <ul style="list-style-type: none"> <li>• 3 N/O relays (10 Watts, 0.5 Amp, 100 VDC)</li> <li>• 3 N/C relays (10 Watts, 0.5 Amp, 100 VDC)</li> </ul>
Serial Communication	
EDP Port	19200, 9600, 4800, 2400, 1200, 600, 300, and 150 baud. Full duplex RS-232 or simplex 20 mA current loop output; RS-485 optional
Operator Interface	
Display	0.8-inch 7-segment, 6-digit high-intensity red LED display; decimal point available at each digit
Status Annunciators	lb, kg, g, oz, net, motion, center of zero, neg
Keyboard	8-key touch control with international symbols
Bar Graph	5-segment, 7-range programmable multicolored array tracks Over, Under, Accept status in relation to target value
Display Resolution	Selectable up to 10,000 dd for NTEP, Class III

**Caution**

*For protection against risk of fire, replace fuses only with same type and rating as original equipment.*

<b>Power</b>	
<b>Line Voltages</b>	Available in 115 VAC, 230 VAC Optional 6 VDC battery backup
<b>Frequency</b>	50 or 60 Hz
<b>Fusing</b>	115 VAC: 2 x 250 mA TR5 subminiature fuses Wickmann Time-Lag 19374 series UL listed, CSA certified  230 VAC: 2 x 125 mA TR5 subminiature fuses Wickmann Time-Lag 19372 series UL and C-UL recognized, Semko and VDE approved
<b>Environmental</b>	
<b>Operating Temperature</b>	14° to 104°F (-10° to 40°C)
<b>Emissions/Immunity</b>	FCC Part 15 Class A, CISPR 22 Class A
<b>Enclosure Classification</b>	NEMA 4X/IP66 indicator enclosure
<b>Enclosure Materials</b>	304 stainless steel
<b>Mechanical</b>	
<b>Capacities Available</b>	
6 lb	6 x .002 lb / 96 x .05 oz / 3 x .001 kg / 3,000 x 1 g
10 lb	10 x .005 lb / 160 x .1 oz / 5 x .002 kg / 5,000 x 2 g
15 lb	15 x .005 lb / 240 x .1 oz / 7 x .002 kg / 7,500 x 5 g
30 lb	30 x .01 lb / 480 x .2 oz / 15 x .005 kg / 15,000 x 5 g
60 lb	60 x .02lb / 960 x .5 oz / 30 x .01 kg / 30,000 x 10 g
100 lb	100 x .02 lb / 1,600 x .5oz / 50 x .01 kg / 50,000 x 10 g
200 lb	200 x .05 lb / 3,200 x 1 oz / 100 x .02 kg / 100,000 x 20 g
300 lb	300 x .1lb / 4,800 x 1 oz / 150 x .05 kg / 150,000 x 50 g
500 lb	500 x .1 lb / 8,000 x 2 oz / 250 x .05 kg / 250,000 x 50 g
1000 lb	1000 x .2 lb / 16,000 x 5 oz / 500 x .1 kg / 500,000 x 100



<b>Indicator Dimensions</b>		9.5" W x 8.5" H x 3.25" D (241 mm x 216 mm x 83 mm)
<b>Platform/Column Dimensions</b>		
(6, 10, 15, 30) lb		<i>Platform:</i> 10" L x 10" W x 3" H (254.0 mm x 254.0 mm x 76.2 mm ) <i>Column:</i> 12" H (304.8 mm)
(30, 60, 100) lb		<i>Platform:</i> 12" L x 12" W x 3" H (304.8 mm x 304.8 mm x 76.2 mm) <i>Column:</i> 12" H (304.8 mm)
(100, 200, 300, 500, 1000) lb		<i>Platform:</i> 18" L x 18" W x 5.25" H (457.2 mm x 457.2 mm x 133.3 mm) <i>Column:</i> 18" H (457.2 mm)
(200, 300, 500, 1000) lb		<i>Platform:</i> 24" L x 18" W x 5.25" H (609.6 mm x 457.2 mm x 133.3 mm) <i>Column:</i> 18" H (457.2 mm)
(200, 300, 500, 1000) lb		<i>Platform:</i> 24" L x 24" W x 5.25" H (609.6 mm x 609.6 mm x 133.3 mm) <i>Column:</i> 18" H (457.2 mm)
<b>Weights</b>		
(6, 10, 15, 30) lb	20 lb (9.07 kg)	
(30, 60, 100) lb	23 lb (10.4 kg)	
(100, 200, 300, 500, 1000) lb	78 lb (35.4 kg)	
(200, 300, 500, 1000) lb	95 lb (43.1 kg)	
(200, 300, 500, 1000) lb	110 lb (49.9 kg)	
<b>NTEP</b>		
CW-80 indicator:	CC# 96-118 Certified for 10,000 divisions, Class III/IIIL	
CW-80 platform:	CC# 96-107 Certified for 3,000 divisions, Class III	
<b>Measurement Canada</b>		
CW-80 indicator:	AM-5146 Certified for 10,000 divisions, Class III/III HD	
CW-80 platform:	AM-5156 Certified for 3,000 divisions, Class III	
<b>OIML</b>		
CW-80 indicator and base:	OIML Certificate R76/1992-DE-97.02 EC Type Approval Certificate D97-09-033	
CW-80 indicator only (CW-80I):	Test certificate R76-1/EN45501, D09-97.16	
<b>UL/C-UL</b>		
Listed to UL 1950/CSA C22.2 No. 950 Standards		
		

## Assembly Drawings

Figures 9-1 through 9-6 are assembly drawings for the CW-80 head, column and base. Also included is the battery box and charger. Figure 9-6 shows dimensions for all available sizes.

**Figure 9-1. Head (rear and side view)**

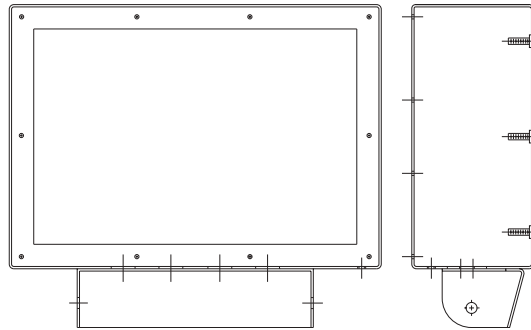

**Figure 9-2. Column (rear and side view)**

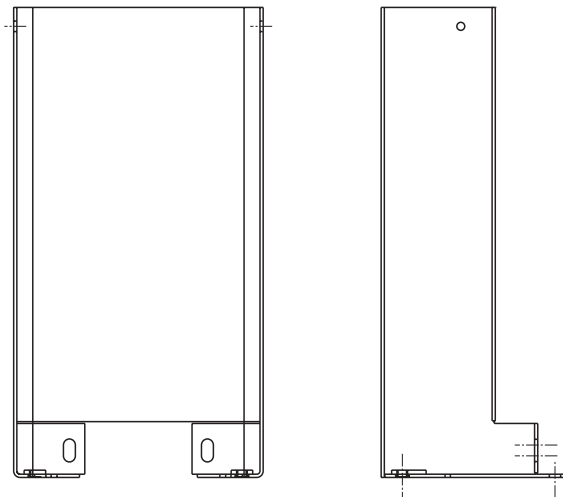

**Figure 9-3. Base (cutaway view)**

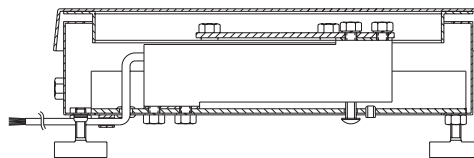

**Figure 9-4. Battery and box**

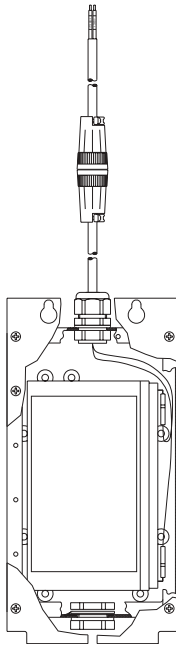

**Figure 9-5. Battery charger**

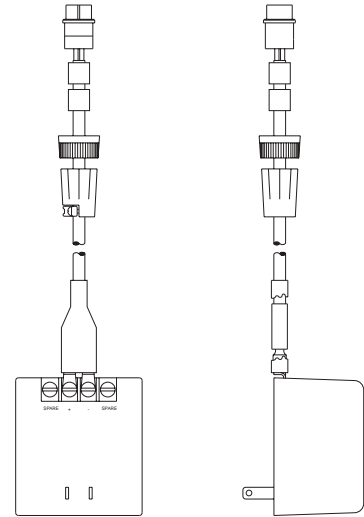

**Figure 9-6. CW-80 dimensions**

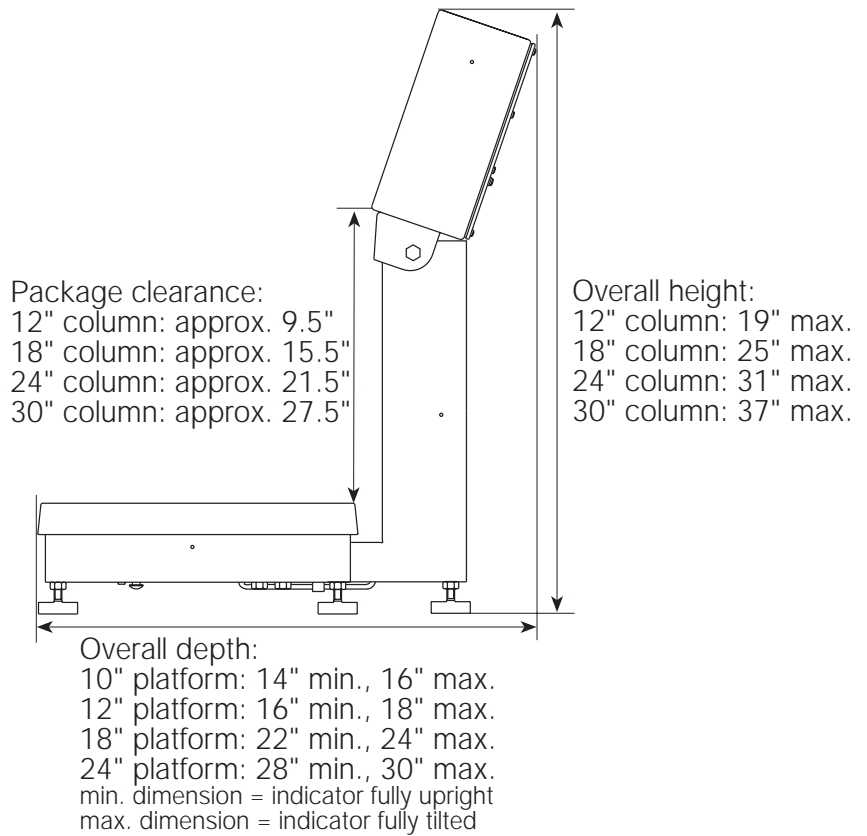

## Replacement Parts List

### Indicator and Column Assemblies

Ref .....	Part	Description
1 .....	30203	Backplate
2 .....	65888	Gasket, rear panel
3 .....	30341	Gasket, front panel
4 .....	30295	Indicator box
5 .....	22086	Screw, 6-32NC x 1/4 Phillips pan head, SS
6 .....	30625	Washer, plain #8 nylon
7 .....	14862	Screw, sealing 8-32NC x 3/8 Phillips pan head
8 .....	42640	Screw, 1/4-20NC x 1/4 drilled fillister
9 .....	44676	Washer, bonded sealing, #14
10 .....	15626	Cord grip assembly, PG9
11 .....	19538	Plug, post screw
12 .....	31294	Power supply board, 115VAC
12 .....	31295	Power supply board, 230VAC
12 .....	31701	Power supply board, 115VAC w/BBU charging circuit & TTL
12 .....	32141	Power supply board, 230VAC w/BBU charging circuit & TTL
12 .....	32142	Power supply board, 115VAC w/BBU charging circuit & N.O. relays
12 .....	32143	Power supply board, 230VAC w/BBU charging circuit & N.O. relays
12 .....	32144	Power supply board, 115VAC w/BBU charging circuit & N.C. relays
12 .....	32145	Power supply board, 230VAC w/BBU charging circuit & N.C. relays
.....	32149	Fuse, 3/4 A, 250 VAC (115 VAC models)
.....	32151	Fuse, 1/2A, 220 VAC (230 VAC models)
.....	32415	Relay, form A, N.O.
.....	32416	Relay, form B, N.C.
.....	32717	Transformer
13 .....	14831	Screw, MACH 4-40NC x 5/16 Phillips pan head, locking
14 .....	31597	Standoff, male-female, 4-40NC x 3/4 1/4 Hex, steel
15 .....	31421	Board, CPU/Display, Version 1.1
16 .....	14626	Nut, Kep 8-32 hex external tooth lockwasher
17 .....	29788	Keypad, piezo
18 .....	15388	Standoff, male-female 4-40NC x 3/8 1/4 Hex, steel
19 .....	31596	Standoff, male-female 4-40NC x 7/16 1/4 Hex, steel
20 .....	15650	Cable tie mount
.....	15631	3" nylon tie
21 .....	32184	Line filter assembly
22 .....	31595	Support, for circuit board
23 .....	41965	Power cord assembly, 115 VAC
23 .....	45254	Power cord assembly, 230 VAC
24 .....	14956	Bolt, 1/4-20 hex head
26 .....	30208	Column, 30"
26 .....	30207	Column, 24"
26 .....	30206	Column, 18"
26 .....	30205	Column, 12"
28 .....	30623	Screw, 8-32-NC x 7/16 slotted fillister, SS
29 .....	71349	Breather filter

See drawing on next page...

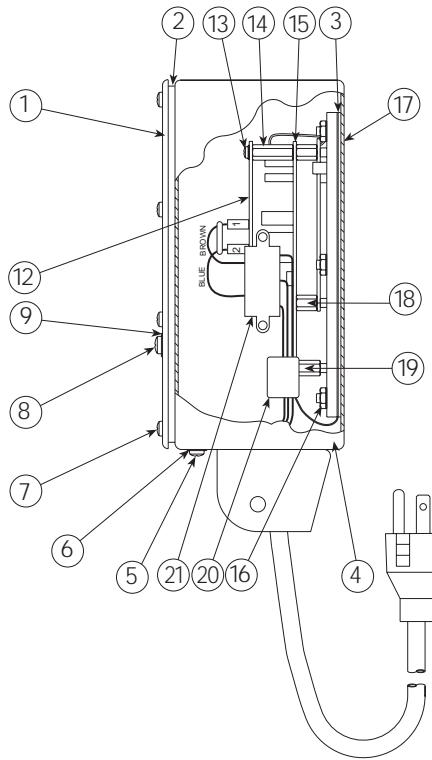

**Additional Replacement Parts**

- 47966 Shield, high-voltage
- 30907 Indicator stand/wall-mount bracket
- 32388 Battery back-up unit
- 32387 Cable assembly, battery backup box
- 15671 Cable grip, 1/4 NPT, battery backup box
- 31223 Relief valve, battery backup box
- 30330 Enclosure, battery backup box
- 30204 Standoff 1/4-20 x 1"
- 15664 Reducing gland, 9 mm x 3/8 NPT
- 30375 Seal ring, nylon
- 15627 Lock nut, cord grips
- 15134 Lock washer, #8
- 15369 Line filter standoff, female 6-32 NC x 3/4
- 16892 Cable, ground
- 32292 Guide tube
- 45043 Wire, ground, 4"
- 35993 115 VAC fuse, 250 mA (2)
- 46421 230 VAC fuse, 125 mA (2)

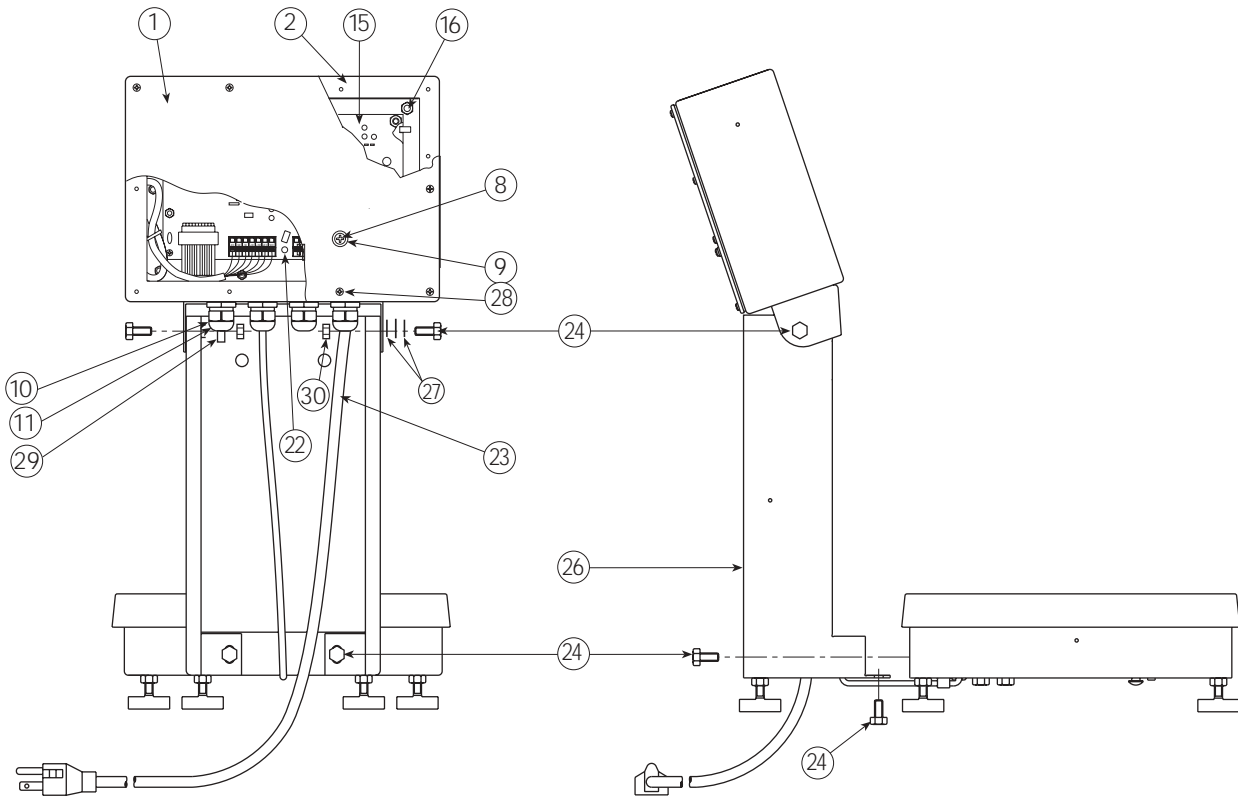

## 10" x 10" Base Assembly

Ref	Part #	Description
2	14920	Screw, overload protection, 8-32NC x 1/4
3	35128	Foot, 1/4-20NC
4	14645	Jam nut, foot
5	19086	Bottom subassembly
6	15220	Rivet, sealing
7	16863	Label, bench scale
8	19091	Cover, top, 10" x 10"
9	19088	Top subassembly
10	15148	Washer, lock, #8 SS
11	14963	Screw, cap, 1/4-20NC x 3/4
12	15410	Spirit level bubble, plastic
13	30783	Load cell, RL1380, 6 kg (6 lb model)
13	30782	Load cell, RL1380, 10 kg (10 lb model)
13	30781	Load cell, RL1380, 15 kg (15 lb model)
13	30780	Load cell, RL1380, 30 kg (30 lb model)
14	15132	Washer, lock, #8 SS
15	14857	Screw, pan head
16	15408	Grommet, rubber, 3/16 ID
17	16141	Cable tie
18	14984	Bolt, overload spring (6–15 lb models)
18	21947	Bolt, overload spring (30 lb model)
19	21945	Spring, overload (6 lb model)
19	15416	Spring, overload (10 lb model)
19	21946	Spring, overload (15 lb model)
19	21944	Spring, overload (30 lb model)
20	15149	Washer, flat, SS
21	14634	Nut, nylon insert, 1/4-20NC, SS
22	35082	Shim, load cell
23	15409	Clamp, nylon cable
24	49451	Load plate
25	15150	Washer, sealing, 5/16
26	15138	Washer #8 SS
27	14862	Screw, cable clamp, 8-32NC x 3/8

### OIML Models

13	30780	Load cell, RL1380, 30 kg (15 kg model)
24	19090	Load plate

## 12" x 12" Base Assembly

Ref	Part #	Description
1	14951	Screw, cap, 1/4-28NF x 3/8 (100 lb only)
2	14920	Screw, overload protection, 8-32NC x 1/4
3	35128	Foot, 1/4-20NC
4	14645	Jam nut, foot
5	35066	Bottom subassembly
6	15220	Rivet, sealing
7	16863	Label, bench scale (30 and 60 lb models)
7	16907	Label, bench scale (100 lb model)
8	35069	Cover, top, 12" x 12"
9	35068	Top subassembly
10	15148	Washer, lock, #8 SS
11	14963	Screw, cap, 1/4-20NC x 3/4 (30 and 60 lb)
11	14956	Screw, cap, 1/4-20NC x 1/2 (100 lb)
12	15410	Spirit level bubble, plastic
13	30780	Load cell, RL1380, 30 kg (30 lb model)
13	30779	Load cell, RL1380, 50 kg (60 lb model)
13	40964	Load cell, RL1042, 100 kg (100 lb model)
14	15132	Washer, lock, #8 SS
15	14857	Screw, pan head
16	15408	Grommet, rubber, 3/16 ID
17	16141	Cable tie
18	21947	Bolt, overload spring (30 lb model)
18	14984	Bolt, overload spring (60 lb model)
18	35199	Bolt, overload spring (100 lb model)
19	21944	Spring, overload (30 lb model)
19	35086	Spring, overload (60 lb model)
19	35200	Spring, overload (100 lb model)
20	15149	Washer, flat, SS
21	14634	Nut, nylon insert, 1/4-20NC, SS
22	35082	Shim, load cell (30 and 60 lb models)
22	19089	Shim, load cell (100 lb model)
23	15409	Clamp, nylon cable
24	49450	Load plate (30 and 60 lb models)
24	35067	Load plate (100 lb model)
25	15150	Washer, sealing, 5/16
26	15138	Washer #8 SS
27	14862	Screw, cable clamp, 8-32NC x 3/8

### OIML Models

13	30780	Load cell, RL1380, 30 kg (15 kg model)
13	30779	Load cell, RL1380, 50 kg (30 kg model)
24	19090	Load plate

*See parts drawings on next page...*

# 10" x 10" and 12" x 12" Base Assemblies

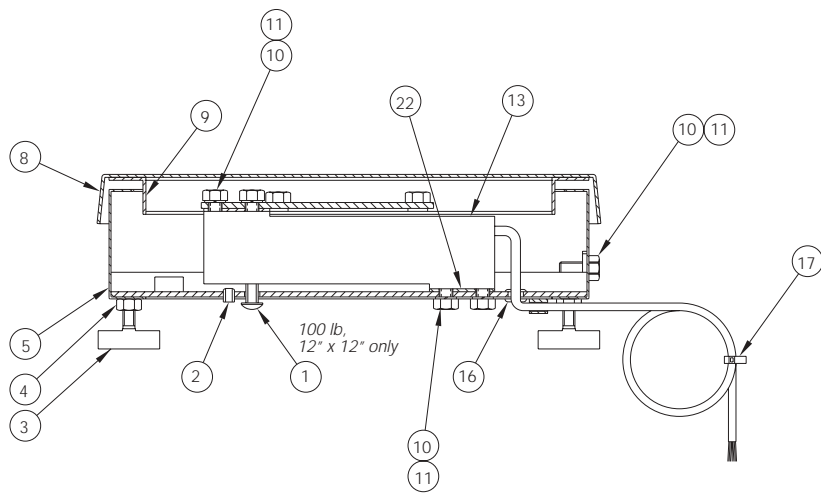
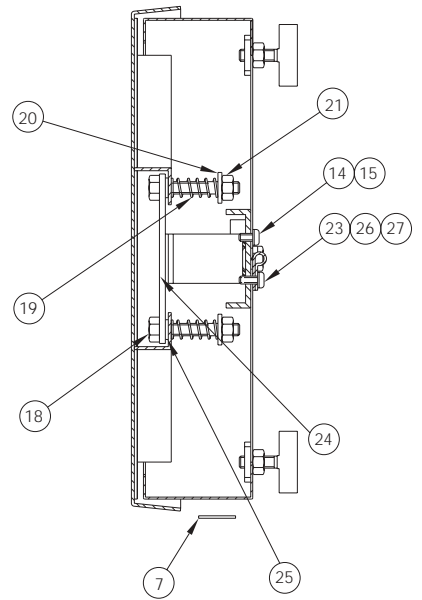
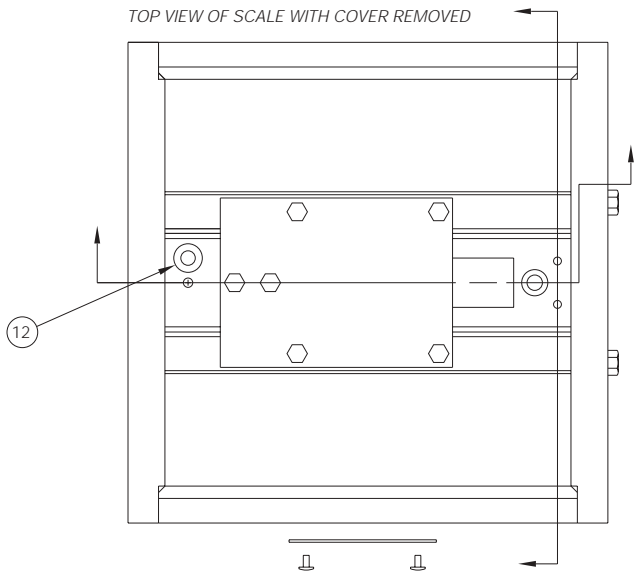

## 18" x 18", 18" x 24", 24" x 24" Base Assemblies

Ref	Part #	Description
1	19141 .....	Foot, 3/8-16 x .78
2	14653 .....	Jam nut, foot SS
3	49768 .....	Frame, bottom, 18" x 18"
3	49772 .....	Frame, bottom, 18" x 24"
3	49776 .....	Frame, bottom, 24" x 24" (RL1260 models)
3	19114 .....	Frame, bottom, 24" x 24" (RL1250 model)
4	16907 .....	Label, bench scale
5	15220 .....	Rivet, sealing
6	15020 .....	Screw, cap, 3/8-16NC x 1
7	19094 .....	Cover, top, 18" x 18"
7	19095 .....	Cover, top, 18" x 24"
7	19096 .....	Cover, top, 24" x 24"
8	26407 .....	Bumper, square self adhesive
9	15154 .....	Lock washer, 5/16
10	49789 .....	Screw cap, 5/16-18NC x 1 1/4, SS (RL1260 models)
10	26670 .....	Screw cap, 5/16-18NC x 1, SS (RL1250 model)
11	49786 .....	Plate, washer SS (RL1260 models)
11	19103 .....	Plate, washer SS (1000 lb 24" x 24" model)
12	15410 .....	Spirit level bubble, plastic
14	49767 .....	Frame, top, 18" x 18"
14	49771 .....	Frame, top, 18" x 24"
14	49775 .....	Frame, top, 24" x 24" (RL1260 models)
14	19114 .....	Frame, top, 24" x 24" (RL1250 model)
15	15418 .....	Grommet, rubber, 3/16 ID
16	15047 .....	Screw, set, 1/2-20NF x 1/2
17	15409 .....	Clamp, nylon cable
18	15138 .....	Washer, #8 SS
19	15132 .....	Lock washer, #8 Type A
20	26670 .....	Screw cap, 5/16-18NC x 1, SS (RL1260 models)
20	26669 .....	Screw cap, 5/16-18NC x 3/4, SS (RL1250 model)
21	16141 .....	Cable tie
22	14862 .....	Screw, 8-32NC x 3/8 (18" x 18" models, 1000 lb 24" x 24" model)
22	14857 .....	Screw, 8-32NC x 1/4 (18" x 24" and 24" x 24" RL1260 models)
23	49787 .....	Shim plate, (RL1260 models)
23	22264 .....	Shim plate, (RL1250 model)
24	41022 .....	Load cell, RL1260-N5, 100 kg (100 lb models)
24	41023 .....	Load cell, RL1260-N5, 200 kg (200 lb models)
24	41025 .....	Load cell, RL1260-N5, 300 kg (300 lb models)
24	41026 .....	Load cell, RL1260-N5, 500 kg (500 lb models)
24	41027 .....	Load cell, RL1260-N5, 635 kg (1000 lb, 18" models)
24	32858 .....	Load cell, RL1250-N5, 1000 kg (1000 lb, 24" x 24" model)
25	35199 .....	Screw cap, 1/4-20NC x 2, SS
26	15149 .....	Washer, 1/4 Type A
27	14634 .....	Lock nut, 1/4-20NC

*See parts drawings on next page...*



# 18" x 18", 18" x 24", and 24" x 24" Base Assemblies

TOP VIEW OF SCALE WITH COVER REMOVED

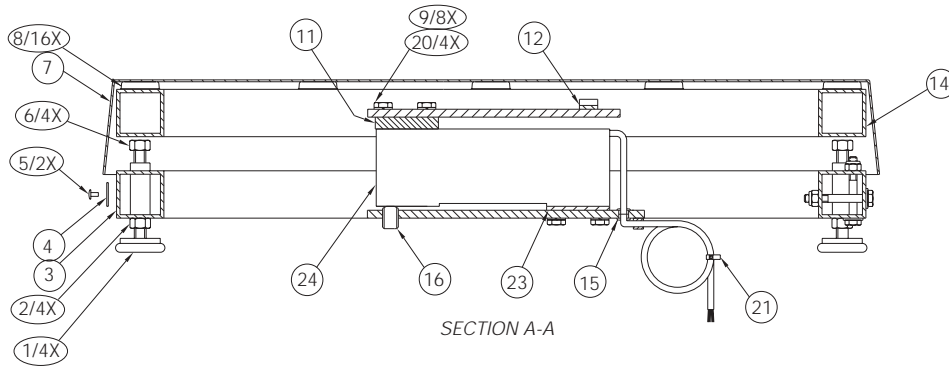
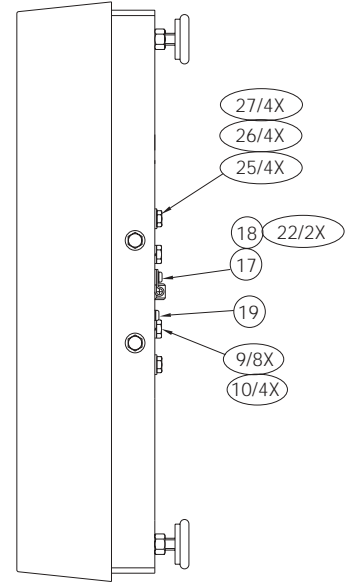
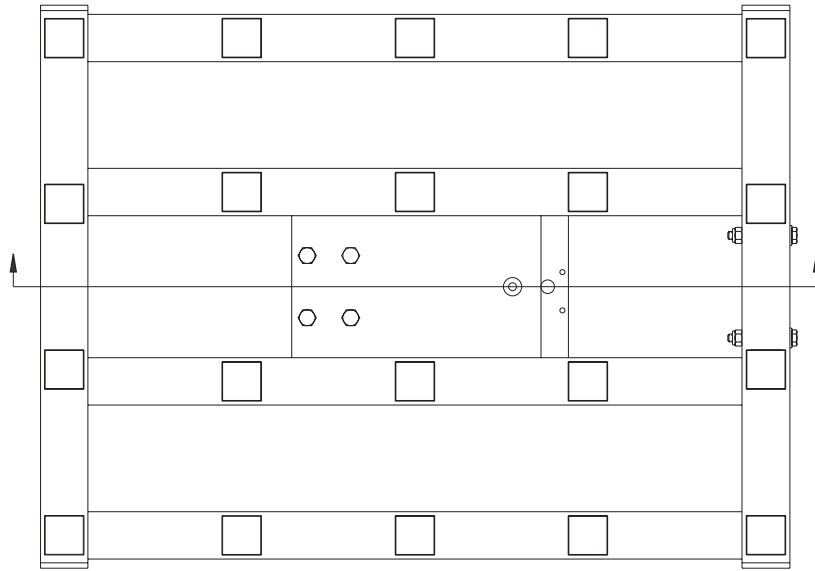

# ASCII Character Chart

Table 9-1. ASCII characters with decimal and HEX equivalents

ASCII	DEC	HEX	ASCII	DECIMAL	HEX	ASCII	DECIMAL	HEX	ASCII	DECIMAL	HEX	
Ctrl @	NUL	0	00	@	64	40	Ç	128	80		192	C0
Ctrl A	SOH	1	01	A	65	41	ü	129	81		193	C1
Ctrl B	STX	2	02	B	66	42	é	130	82		194	C2
Ctrl C	ETX	3	03	C	67	43	à	131	83		195	C3
Ctrl D	EOT	4	04	D	68	44	ä	132	84		196	C4
Ctrl E	ENQ	5	05	E	69	45	«a	133	85		197	C5
Ctrl F	ACK	6	06	F	70	46	à	134	86	ã	198	C6
Ctrl G	BEL	7	07	G	71	47	ç	135	87	A	199	C7
Ctrl H	BS	8	08	H	72	48	ê	136	88		200	C8
Ctrl I	HT	9	09	I	73	49	è	137	89		201	C9
Ctrl J	LF	10	0A	J	74	4A	«e	138	8A		202	CA
Ctrl K	VT	11	0B	K	75	4B	ï	139	8B		203	CB
Ctrl L	FF	12	0C	L	76	4C	î	140	8C		204	CC
Ctrl M	CR	13	0D	M	77	4D	«i	141	8D		205	CD
Ctrl N	SO	14	0E	N	78	4E	a	142	8E		206	CE
Ctrl O	SI	15	0F	O	79	4F	À	143	8F		207	CF
Ctrl P	DLE	16	10	P	80	50	´E	144	90	õ	208	D0
Ctrl Q	DC1	17	11	Q	81	51	æ	145	91	D	209	D1
Ctrl R	DC2	18	12	R	82	52	Æ	146	92	E	210	D2
Ctrl S	DC3	19	13	S	83	53	ô	147	93	Ë	211	D3
Ctrl T	DC4	20	14	T	84	54	ö	148	94	E	212	D4
Ctrl U	NAK	21	15	U	85	55	«o	149	95		213	D5
Ctrl V	SYN	22	16	V	86	56	û	150	96		214	D6
Ctrl W	ETB	23	17	W	87	57	«u	151	97	í	215	D7
Ctrl X	CAN	24	18	X	88	58	y	152	98	î	216	D8
Ctrl Y	EM	25	19	Y	89	59	ÿ	153	99		217	D9
Ctrl Z	SUB	26	1A	Z	90	5A	Ö	154	9A		218	DA
Ctrl [	ESC	27	1B	[	91	5B	ø	155	9B		219	DB
Ctrl \	FS	28	1C	\	92	5C	£	156	9C		220	DC
Ctrl ]	GS	29	1D	]	93	5D	Ø	157	9D		221	DD
Ctrl ^	RS	30	1E	^	94	5E	x	158	9E	«i	222	DE
Ctrl _	US	31	1F	_	95	5F	f	159	9F		223	DF
	space	32	20		96	60	á	160	A0	Ó	224	E0
	!	33	21	!	97	61	í	161	A1	ß	225	E1
	"	34	22	"	98	62	ó	162	A2	Ó	226	E2
	#	35	23	#	99	63	ú	163	A3	Ó	227	E3
	\$	36	24	\$	100	64	ñ	164	A4	Ó	228	E4
	%	37	25	%	101	65	Ñ	165	A5	Ó	229	E5
	&	38	26	&	102	66	?	166	A6	μ	230	E6
	'	39	27	'	103	67	°	167	A7	p	231	E7
	(	40	28	(	104	68	¿	168	A8	p	232	E8
	)	41	29	)	105	69	®	169	A9	U	233	E9
	*	42	2A	*	106	6A	1/2	170	AA	U	234	EA
	+	43	2B	+	107	6B	1/2	171	AB	U	235	EB
	,	44	2C	,	108	6C	1/4	172	AC	ÿ	236	EC
	-	45	2D	-	109	6D	1/4	173	AD	ÿ	237	ED
	.	46	2E	.	110	6E	i	174	AE		238	EE
	/	47	2F	/	111	6F	-	175	AF		239	EF
	0	48	30	0	112	70		176	B0		240	F0
	1	49	31	1	113	71		177	B1	±	241	F1
	2	50	32	2	114	72	²	178	B2		242	F2
	3	51	33	3	115	73	³	179	B3	3/4	243	F3
	4	52	34	4	116	74	´	180	B4		244	F4
	5	53	35	5	117	75	«A	181	B5		245	F5
	6	54	36	6	118	76	^A	182	B6	+	246	F6
	7	55	37	7	119	77	A	183	B7	,	247	F7
	8	56	38	8	120	78	©	184	B8	o	248	F8
	9	57	39	9	121	79	¹	185	B9	"	249	F9
	:	58	3A	:	122	7A		186	BA	.	250	FA
	;	59	3B	;	123	7B	«	187	BB		251	FB
	<	60	3C	<	124	7C		188	BC		252	FC
	=	61	3D	=	125	7D	¢	189	BD		253	FD
	>	62	3E	>	126	7E	¥	190	BE		254	FE
	?	63	3F	?	127	7F		191	BF		255	FF
				DEL	127	7F						

## **Software Revision History**

### **Version 1.0 4/95**

Original release.

### **Version 1.1 7/95**

1. Numeric Display Blanking added.
2. <CR> as well as <CR><LF> allowed bidirectionally as commands.

### **Version 1.2**

1. Keypad tactile sensitivity decreased

### **Version 1.3 8/96**

1. Legal-For-Trade (LFT) print format added

## **CW-80 Limited Warranty**

Rice Lake Weighing Systems (RLWS) warrants that all RLWS equipment and systems properly installed by a Distributor or Original Equipment Manufacturer (OEM) will operate per written specifications as confirmed by the Distributor/OEM and accepted by RLWS. All systems and components are warranted against defects in materials and workmanship for two (2) years.

RLWS warrants that the equipment sold hereunder will conform to the current written specifications authorized by RLWS. RLWS warrants the equipment against faulty workmanship and defective materials. If any equipment fails to conform to these warranties, RLWS will, at its option, repair or replace such goods returned within the warranty period subject to the following conditions:

- Upon discovery by Buyer of such non-conformity, RLWS will be given prompt written notice with a detailed explanation of the alleged deficiencies.
- Individual electronic components returned to RLWS for warranty purposes must be packaged to prevent electrostatic discharge (ESD) damage in shipment. Packaging requirements are listed in a publication, "Protecting Your Components From Static Damage in Shipment," available from RLWS Equipment Return Department.
- Examination of such equipment by RLWS confirms that the non-conformity actually exists, and was not caused by accident, misuse, neglect, alteration, improper installation, improper repair or improper testing; RLWS shall be the sole judge of all alleged non-conformities.
- Such equipment has not been modified, altered, or changed by any person other than RLWS or its duly authorized repair agents.
- RLWS will have a reasonable time to repair or replace the defective equipment. Buyer is responsible for shipping charges both ways.
- In no event will RLWS be responsible for travel time or on-location repairs, including assembly or disassembly of equipment, nor will RLWS be liable for the cost of any repairs made by others.

**THESE WARRANTIES EXCLUDE ALL OTHER WARRANTIES, EXPRESSED OR IMPLIED, INCLUDING WITHOUT LIMITATION WARRANTIES OF MERCHANTABILITY OR FITNESS FOR A PARTICULAR PURPOSE. NEITHER RLWS NOR DISTRIBUTOR WILL, IN ANY EVENT, BE LIABLE FOR INCIDENTAL OR CONSEQUENTIAL DAMAGES.**

**RLWS AND BUYER AGREE THAT RLWS'S SOLE AND EXCLUSIVE LIABILITY HEREUNDER IS LIMITED TO REPAIR OR REPLACEMENT OF SUCH GOODS. IN ACCEPTING THIS WARRANTY, THE BUYER WAIVES ANY AND ALL OTHER CLAIMS TO WARRANTY.**

**SHOULD THE SELLER BE OTHER THAN RLWS, THE BUYER AGREES TO LOOK ONLY TO THE SELLER FOR WARRANTY CLAIMS.**

No terms, conditions, understanding, or agreements purporting to modify the terms of this warranty shall have any legal effect unless made in writing and signed by a corporate officer of RLWS and the Buyer.

2003 Rice Lake Weighing Systems, Inc. Rice Lake, WI USA. All Rights Reserved.

**RICE LAKE WEIGHING SYSTEMS • 230 WEST COLEMAN STREET • RICE LAKE, WISCONSIN 54868 • USA**